

The Law Society of the Australian Capital Territory: Contract for Sale Schedule

Land	The unexpired term of the Lease	Unit	UP No.	Block	Section	Division/District
				29	8	Garran
		and known as 97 Fitchett Street, Garran ACT 2605				
Seller	Full name	Heidi Ingrid Hutchison and Michael David Hutchison				
	ACN/ABN					
	Address	97 Fitchett Street, Garran ACT 2605				
Seller Solicitor	Firm	Snedden Hall & Gallop				
	Email	property@shglawyers.com.au				
	Phone	02 6285 8000	Ref	82681 Tom Lindenmayer		
	DX/Address	43-49 Geils Court, Deakin ACT 2600				
Stakeholder	Name	Hive Property (ACT) Pty Ltd Trust Account				
Seller Agent	Firm	Hive Property (ACT) Pty Ltd				
	Email	eva@hiveproperty.co				
	Phone	0415668718	Ref:	Eva Bono		
	DX/Address	Level 1, 4 Campion Street, Deakin ACT 2600				
Restriction on Transfer	Mark as applicable	<input checked="" type="checkbox"/> Nil <input type="checkbox"/> section 370 <input type="checkbox"/> section 280 <input type="checkbox"/> section 306 <input type="checkbox"/> section 351				
Land Rent	Mark one	<input checked="" type="checkbox"/> Non-Land Rent Lease <input type="checkbox"/> Land Rent Lease				
Occupancy	Mark one	<input checked="" type="checkbox"/> Vacant possession <input type="checkbox"/> Subject to tenancy				
Breach of covenant or unit articles	Description (Insert other breaches)	As disclosed in the Required Documents and this Contract, if any.				
Goods	Description	Fixed floor coverings, light fittings and window treatments as inspected.				
Date for Registration of Units Plan						
Date for Completion On or before 30 days from the Date hereof						
Electronic Transaction? <input type="checkbox"/> No <input checked="" type="checkbox"/> Yes, using Nominated ELN: PEXA						
Land Tax to be adjusted? <input type="checkbox"/> No <input checked="" type="checkbox"/> Yes						
Residential Withholding Tax	New residential premises?		<input checked="" type="checkbox"/> No		<input type="checkbox"/> Yes	
	Potential residential land?		<input checked="" type="checkbox"/> No		<input type="checkbox"/> Yes	
	Buyer required to make a withholding payment?		<input checked="" type="checkbox"/> No		<input type="checkbox"/> Yes (insert details on p.3)	
Foreign Resident Withholding Tax	Relevant Price more than \$750,000.00?		<input type="checkbox"/> No		<input type="checkbox"/> Yes	
	Clearance Certificates attached for all the Sellers?		<input checked="" type="checkbox"/> No		<input type="checkbox"/> Yes	

An agent may only complete the details in this black box and exchange this contract. See page 3 for more information.

Buyer	Full name					
	ACN/ABN					
	Address					
Buyer Solicitor	Firm					
	Email					
	Phone		Ref			
	DX/Address					
Price	Price	\$	(GST inclusive unless otherwise specified)			
	Less deposit	\$	(10% of Price)	<input type="checkbox"/> Deposit by Instalments (clause 52 applies)		
	Balance	\$				
Date of this Contract						

Co-Ownership	Mark one (show shares)	<input type="checkbox"/> Joint tenants	<input type="checkbox"/> Tenants in common in the following shares:
---------------------	------------------------	--	---

Read This Before Signing: Before signing this Contract you should ensure that you understand your rights and obligations. You should read the important notes on page 3. You should get advice from your solicitor.

Seller signature	Buyer signature
Seller witness name and signature	Buyer witness name and signature

Seller Disclosure Documents

The following marked documents are attached and form part of this Contract. The Buyer acknowledges that by execution of this Contract the Buyer certifies in writing that the Buyer received the marked documents prior to entering into this Contract.

- Crown lease of the Land (including variations)
- Current certified extract from the land titles register showing all registered interests affecting the Property
- Deposited Plan for the Land
- Energy Efficiency Rating Statement
- Encumbrances shown on the land titles register (excluding any mortgage or other encumbrance to be discharged)
- If there is an encumbrance not shown on the land titles register — a statement about the encumbrance complying with the Civil Law (Sale of Residential Property) Regulations
- Lease Conveyancing Inquiry Documents for the Property
- Building Conveyancing Inquiry Document (except if:
 - the Property is a Class A Unit
 - the residence on the Property has not previously been occupied or sold as a dwelling; or
 - this Contract is an “off-the-plan purchase”)
- Building and Compliance Inspection Report(s) (except if section 9(2)(a)(ii) or section 9(2)(a)(iii) of the Sale of Residential Property Act applies).
- Pest information (except if the property is a Class A Unit or is a residence that has never been occupied): Pest Inspection Report(s).
- Regulated Swimming Pool documentation required under section 9 (1)(ja) of the Sale of Residential Property Act (on and from 1 May 2024).

If the Property is off-the-plan:

- Proposed plan
- Inclusions list

If the Property is a Unit where the Units Plan is not registered:

- Inclusions list
- Disclosure Statement

If the Property is a Unit where the Units Plan is registered:

- Units Plan concerning the Property
- Current certified extract from the land titles register showing all registered interests affecting the Common Property
- Unit Title Certificate
- Registered variations to rules of the Owners Corporation
- (If the Unit is an Adaptable Housing Dwelling) drawings and plans demonstrating compliance with Australian Standard AS 4299-1995 (Adaptable Housing) as in force from time to time
- (If the Owners Corporation is a party to a Building Management Statement) Building Management Statement

If the Property is a Lot that is part of a Community Title Scheme:

- Section 67 Statement, as first or top sheet
- Community Title Master Plan
- Community Title Management Statement

If the Property is a Lot that will form part of a Community Title Scheme:

- Proposed Community Title Master Plan or sketch plan
- Proposed Community Title Management Statement

GST

- Not applicable
- Input taxed supply of residential premises
- Taxable supply (including new residential premises)
- GST-free supply of going concern
- Margin scheme applies

Tenancy

- Tenancy Agreement
- No written Tenancy Agreement exists

Invoices

- Building and Compliance Inspection Report
- Pest Inspection Report

Asbestos

- Asbestos Advice
- Current Asbestos Assessment Report

Damages for delay in Completion – applicable interest rate and legal costs and disbursements amount (see clause 22)

Interest rate if the defaulting party is the Seller	0	% per annum
Interest rate if the defaulting party is the Buyer	10	% per annum
Amount to be applied towards legal costs and disbursements incurred by the party not at fault	\$ 660	(GST inclusive)

Tenancy Summary

Premises		Expiry date	
Tenant name		Rent	
Commencement date		Rent review date	
Term		Rent review mechanism	

Managing Agent Details for Owners Corporation or Community Title Scheme (if no managing agent, secretary)

Name		Phone	
Address			

RW Amount

(residential withholding payment) — further details

The supplier will frequently be the Seller. However, sometimes further information will be required as to which entity is liable for GST (eg if the Seller is part of a GST group, where the GST representative has the GST liability). If more than one supplier, provide details for each supplier.

Supplier	Name			
	ABN		Phone	
	Business address			
	Email			
Residential Withholding Tax	Supplier's portion of the RW Amount:		\$	
	RW Percentage:			%
	RW Amount (ie the amount that the Buyer is required to pay to the ATO):		\$	
	Is any of the consideration not expressed as an amount in money?	<input type="checkbox"/> No	<input type="checkbox"/> Yes	
	If 'Yes', the GST inclusive market value of the non-monetary consideration:		\$	
	Other details (including those required by regulation or the ATO forms):			

Cooling Off Period

(for residential property only)

- The Buyer may rescind this Contract at any time before 5pm on the 5th Business Day after the day this Contract is made except if any circumstance in paragraph 2 applies.
- There is no cooling off period if:
 - the Buyer is a corporation; or
 - the Property is sold by tender; or
 - the Property is sold by auction; or
 - before signing this Contract, the Buyer gives the Seller a certificate in the form required by the Sale of Residential Property Act signed by the Buyer Solicitor; or
 - this Contract is made on the same day the Property was offered for sale by auction but passed in and the Buyer was recorded in the bidders record as a bidder or a person for whom a bidder was bidding.
- A Buyer exercising the cooling off right by rescinding this Contract forfeits 0.25% of the Price. The Seller is entitled to recover the amount forfeited from the Deposit and the Buyer is entitled to a refund of any balance.

Warnings

- The Lease may be affected by the *Residential Tenancies Act 1997 (ACT)* or the *Leases (Commercial & Retail) Act 2001 (ACT)*.
- If a consent to transfer is required by law, see clause 4 as to the obligations of the parties.
- As some risks associated with the Property pass from the Seller to Buyer on the Date of this Contract, (except if the Property is a Unit) the Buyer should take out insurance on the Property on the Date of this Contract.
- The Buyer will usually have to pay stamp duty on the purchase of the Land. The Buyer may incur penalties if the Buyer does not pay the stamp duty within the required time.
- There are serious risks to a Buyer releasing the Deposit before Completion. The Buyer should take legal advice before agreeing to release the Deposit.
- The Buyer should consider the application of the Territory Plan and other planning and heritage issues before signing this Contract.
- If the Lease is a concessional lease then restrictions on transfer and other dealings may apply.

Disputes

If there is a dispute, the Law Society encourages the use of informal procedures such as negotiation, independent expert appraisal or mediation to resolve the dispute.

Exchange of Contract

- 1 An Agent, authorised by the Seller, may:
 - insert:
 - the name and address of, and contact details for, the Buyer;
 - the name and address of, and contact details for, the Buyer Solicitor;
 - the Price;
 - the Date of this Contract,
 - insert in, or delete from, the Goods; and
 - exchange this Contract.
- 2 An Agent must not otherwise insert, delete or amend this Contract.
- 3 **The Agent must not exchange this Contract unless expressly authorised by the Seller or (if a solicitor is acting for the Seller) by the Seller or the Seller Solicitor.**

The Seller agrees to sell and the Buyer agrees to buy the Property for the Price on these terms:

1. Definitions and interpretation

- 1.1 Definitions appear in the Schedule and as follows:

Affecting Interests means any mortgage, encumbrance, lease, lien, charge, notice, order, caveat, writ, or other interest;

Adaptable Housing Dwelling has the meaning in the Sale of Residential Property Act;

Agent has the meaning in the Sale of Residential Property Act;

ATO means the Australian Taxation Office, and includes the Commissioner for Taxation;

Balance of the Price means the Price less the Deposit;

Breach of Covenant means:

- a Development not approved under the Planning Act including a development for which design and siting approval has not been obtained;
- a breach of the Building and Development Provision;

- a breach of any obligation of the Seller in a registered restrictive covenant affecting the Lease;
- a breach of any other term of the Lease;
- a breach of the articles of the Owners Corporation (if the Property is a Unit); or
- an Unapproved Structure;

Building Act means the *Building Act 2004* (ACT);

Building and Development Provision has the meaning in the Planning Act;

Building Conveyancing Inquiry Document has the meaning in the Sale of Residential Property Act;

Building and Compliance Inspection Report has the meaning in the Sale of Residential Property Act;

Building Management Statement has the meaning in the Land Titles Act;

Business Day means any day other than a Saturday, Sunday, public holiday or bank holiday in the Australian Capital Territory;

Class A Unit has the meaning in the Sale of Residential Property Act;

Common Property for a Unit has the meaning in the Unit Titles Act;

Common Property for a Lot that forms part of a Community Title Scheme has the meaning in the Community Title Act;

Community Title Act means the *Community Title Act 2001* (ACT);

Community Title Body Corporate means the entity referred to as such in the Community Title Act;

Community Title Management Statement has the meaning in the Community Title Act;

Community Title Master Plan has the meaning in the Community Title Act;

Community Title Scheme has the meaning in the Community Title Act;

Completion means the time at which this Contract is completed and **Completed** has a corresponding meaning;

Compliance Certificate means a certificate issued for the Lease under section 296 of the *Planning and Development Act 2007*, Division 10.12.2 of the Planning Act or under section 28 of the *City Area Leases Act 1936* or under section 180 of the Land Act;

Covenant includes a restrictive covenant;

Default Notice means a notice in accordance with clause 18.5 and clause 18.6

Default Rules has the meaning in the Unit Titles Management Act;

Deposit means the deposit forming part of the Price;

Developer in respect of a Lot has the meaning in the Community Title Act;

Developer Control Period has the meaning in the Unit Titles Management Act;

Development has the meaning in the Planning Act;

Development Statement has the meaning in the Unit Titles Act;

Disclosure Statement has the meaning in the Property Act;

Disclosure Update Notice has the meaning in section 260(2) of the Property Act;

Encumbrance has the meaning in the Sale of Residential Property Act but excludes a mortgage;

Energy Efficiency Rating Statement has the meaning in the Sale of Residential Property Act;

Excluded Change has the meaning in section 259A(4) of the Property Act;

General Fund Contribution has the meaning in section 78(1) of the Unit Titles Management Act;

GST has the meaning in the *A New Tax System (Goods and Services Tax) Act 1999* (Cth);

GST Rate means the prevailing rate of GST specified as a percentage;

Improvements means the buildings, structures and fixtures erected on and forming part of the Land;

Income includes the rents and profits derived from the Property;

Land Act means the *Land (Planning & Environment) Act 1991* (ACT);

Land Charges means rates, land rent, land tax and other taxes and outgoings of a periodic nature in respect of the Property;

Land Rent Act means the *Land Rent Act 2008* (ACT);

Land Rent Lease means a Lease that is subject to the Land Rent Act;

Land Titles Act means the *Land Titles Act 1925* (ACT);

Lease means the lease of the Land having the meaning in the Planning Act;

Lease Conveyancing Inquiry Document has the meaning in the Sale of Residential Property Act;

Legislation Act means the *Legislation Act 2001*;

Liability of the Owners Corporation means any actual or contingent liability of the Owners Corporation attributable to the Unit on a Unit Entitlement basis (other than normal operating expenses) or expenditure to be made by the Owners Corporation to fulfil its obligations under the Unit Titles Management Act;

Lot has the meaning in the Community Title Act;

Non-Land Rent Lease means a Lease that is not subject to the Land Rent Act;

Notice to Complete means a notice in accordance with clause 18.1 and clause 18.2 requiring a party to complete;

Owners Corporation means the Owners Corporation for the Unit constituted or to be constituted under the Unit Titles Management Act following registration of the Units Plan;

Pest Inspection Report has the meaning in the Sale of Residential Property Act;

Pest Treatment Certificate has the meaning in the Sale of Residential Property Act;

Planning Act means the *Planning Act 2023* (ACT);

Planning and Land Authority has the meaning in the Legislation Act;

Prescribed Building has the meaning in the Building Act;

Prescribed Terms has the meaning in the Residential Tenancies Act;

Property means the unexpired term of the Lease, the Improvements and the Goods, or (if the Land is a Unit) the unexpired term of the Unit Lease, the Improvements and the Goods;

Property Act means the *Civil Law (Property) Act 2006* (ACT);

Required Documents has the meaning in the Sale of Residential Property Act and includes a Unit Title Certificate but excludes a copy of this Contract;

Rescission Notice has the meaning in the Sale of Residential Property Act;

Residential Tenancies Act means the *Residential Tenancies Act 1997* (ACT);

Sale of Residential Property Act means the *Civil Law (Sale of Residential Property) Act 2003* (ACT);

Section 56 Certificate means a certificate for a Lot issued under section 56 of the Community Title Act;

Section 67 Statement means a statement for a Lot complying with section 67(2)-(4) of the Community Title Act;

Service includes air, communication, drainage, electricity, garbage, gas, oil, radio, sewerage, telephone, television, or water service;

Staged Development has the meaning given by section 17(4) of the Unit Titles Act;

Tenancy Agreement includes a lease for any term and whether for residential purposes or otherwise;

Unapproved Structure has the meaning in the Sale of Residential Property Act;

Unit means the Unit referred to in the Schedule and which has the meaning in the Unit Titles Act;

Unit Entitlement for the Unit has the meaning in the Unit Titles Act;

Unit Title is the Lease together with the rights of the registered lessee of the Unit;

Unit Title Certificate means a certificate for the Unit issued under section 119 of the Unit Titles Management Act;

Unit Titles Act means the *Unit Titles Act 2001* (ACT);

Unit Titles Management Act means the *Unit Titles (Management) Act 2011* (ACT);

Units Plan means all the documents relating to the subdivision of the Land registered as the Units Plan for the Unit under the *Land Titles (Unit Titles) Act 1970*; and

Withholding Law means Subdivision 14 of Schedule 1 of the *Taxation Administration Act 1953* (Cth) and associated provisions.

1.2 In this Contract:

- a reference to the Seller or to the Buyer includes the executors, administrators and permitted assigns of any of them, if an individual, and the successors or permitted assigns of any of them, if a corporation;
- the singular includes the plural, and the plural includes the singular;
- a reference to a person includes a body corporate;
- a term not otherwise defined has the meaning in the Legislation Act; and
- a reference to an Act includes a reference to any subordinate legislation made under it or any Act which replaces it.

- 1.3 Headings are inserted for convenience only and are not part of this Contract.
- 1.4 If the time for something to be done or to happen is not a Business Day, the time is extended to the next Business Day, except in the case of clause 2.1.
- 1.5 A reference to “this Contract” extends to the Schedule, any annexure, additional clauses and attachments forming part of this Contract.
- 1.6 If there is more than one buyer or more than one seller the obligations which they undertake bind them jointly and individually.
- 1.7 Where the Buyer consists of more than one person, as between themselves, they agree to buy the Property in the specified manner of Co-ownership or if one alternative is not marked, as joint tenants.
- 1.8 Without limiting clause 13, the parties agree that for the purposes of the *Electronic Transactions Act 2001* (ACT) and the *Electronic Transactions Act 1999* (Cth), this Contract may be signed and/or exchanged electronically.

2. Terms of payment

- 2.1 The Buyer must pay the Deposit on the Date of this Contract, to the Stakeholder or, if no Stakeholder is named, then to the Seller.
- 2.2 The Deposit becomes the Seller’s property on Completion.
- 2.3 The Deposit may be paid by cheque or in cash (up to \$3,000.00) but if it is not paid on time or, if it is paid by cheque which is not honoured on first presentation, the Buyer is in default.
- 2.4 If the Buyer is in default under clause 2.3, then immediately and without the notice otherwise necessary under clause 18, clause 19 applies.
- 2.5 On Completion the Buyer must give the Seller an authority directing the Stakeholder to account to the Seller for the Deposit.
- 2.6 On Completion the Buyer must pay to the Seller in Canberra the Balance of the Price by unendorsed bank cheque, or in cash (up to \$200.00).
- 2.7 Any money payable to the Seller by the Buyer or the Stakeholder must be paid to the Seller or as the Seller Solicitor directs in writing and payment in accordance with that direction will be sufficient discharge to the person paying.
- 2.8 Completion must take place on the Date for Completion or as otherwise determined by this Contract and if not specified or determined, within a reasonable time.

3. Title to the Lease

- 3.1 The Lease is or will before Completion be granted under the Planning Act.
- 3.2 The Lease is transferred subject to its provisions.
- 3.3 The title to the Lease is or will before Completion be registered under the Land Titles Act.
- 3.4 The title to the Lease must be transferred free from all Affecting Interests except as otherwise provided.
- 3.5 The Buyer cannot insist on any Affecting Interests being removed from the title to the Lease before Completion provided, on Completion, the Seller gives the Buyer any documents and registration fees necessary to remove the Affecting Interests.

4. Restrictions on transfer

- 4.1 The Lease is not subject to any restrictions on transfer other than any Restriction on Transfer.
- 4.2 If the Lease is subject to a Restriction on Transfer under the Planning Act due to non-compliance with the Building and Development Provision then this Contract is subject to the grant of the approval referred to in section 370 of the Planning Act. A Restriction on Transfer referring to "section 370" refers to this restriction.
- 4.3 If the Lease is a lease of the type referred to in section 279 of the Planning Act then this Contract is subject to the approval in accordance with the Planning Act. A Restriction on Transfer referring to "section 280" refers to this restriction.
- 4.3A If the Lease is subject to a Restriction on Transfer under section 306 of the Planning Act, then this Contract is subject to the grant of the approval mentioned in sections 306 and 307 of the Planning Act. A Restriction on Transfer referring to "section 306" refers to this restriction.
- 4.3B If the Lease is subject to a Restriction on Transfer under section 351 of the Planning Act, then this Contract is subject to the grant of the approval mentioned in section 351 of the Planning Act. A Restriction on Transfer referring to "section 351" refers to this restriction. Immediately after the Date of this Contract the Seller must do everything reasonably necessary to remove the restriction or obtain the consent required. If requested in writing, the Buyer must join in any application of the Seller and must do everything reasonably necessary to enable the Seller to obtain the consent. The Seller must pay all associated fees in connection with the application.

- 4.4 If the consent referred to in clauses 4.2, 4.3, 4.3A or 4.3B is not granted by the Date for Completion then either party may rescind this Contract (provided that the party seeking to rescind is not then in default) and clause 21 applies.

5. Particulars of title and submission of transfer

- 5.1 Unless clause 5.3 applies the Seller need not provide particulars of title.
- 5.2 No later than 7 days before the Date for Completion, the Buyer must give the Seller a transfer of the Lease in the form prescribed by the Land Titles Act, to be returned by the Seller to the Buyer on Completion in registrable form.
- 5.3 If the Seller is not the registered proprietor of the Lease at the Date of this Contract, the Seller must give to the Buyer no later than 14 days before the Date for Completion a copy of the instrument and any other documents necessary to enable the Seller to be registered as proprietor.

6. Buyer rights and limitations

- 6.1 If the Buyer establishes before Completion that except as disclosed in this Contract there is any Unapproved Structure on the Property, then the Buyer may:
 - 6.1.1 require the Seller to arrange for the Unapproved Structure to be approved before Completion; and
 - 6.1.2 if the Unapproved Structure is not approved before Completion, rescind or complete and sue the Seller for damages.
- 6.2 If the Buyer establishes, immediately before Completion, that, except as disclosed in this Contract:
 - 6.2.1 the Property is subject to an encumbrance other than the encumbrances shown on the title to the Lease; or
 - 6.2.2 the Buyer is not entitled to vacant possession, then the Buyer may either:
 - 6.2.3 rescind; or
 - 6.2.4 complete and sue the Seller for damages.
- 6.3 The Buyer is not entitled to make any requisitions on the title to the Property.
- 6.4 The Buyer cannot make a claim or objection or rescind or terminate in respect of:
 - 6.4.1 a Service for the Property being a joint service or passing through another property, or any Service for another property passing through the Property;
 - 6.4.2 a wall being or not being a party wall or the Property being affected by an

easement for support or not having the benefit of an easement for support;

- 6.4.3 any change in the Property due to fair wear and tear before Completion;
- 6.4.4 a promise, representation or statement about this Contract, the Property or the Lease, not made in this Contract;
- 6.4.5 any Breach of Covenant described in the Schedule or disclosed elsewhere in this Contract;
- 6.4.6 the ownership or location of any dividing fence;
- 6.4.7 the ownership of any fuel storage tank; and
- 6.4.8 anything disclosed in this Contract (except an Affecting Interest).

7. Seller warranties

7.1 The Seller warrants that at the Date of this Contract:

- 7.1.1 the Seller will be able to complete at Completion;
- 7.1.2 the Seller has no knowledge of any unsatisfied judgment, order or writ affecting the Property;
- 7.1.3 the Seller has no knowledge of any current or threatened claims, notices or proceedings that may lead to a judgment, order or writ affecting the Property; and
- 7.1.4 the Seller is not aware of any material change in the matters disclosed in the Required Documents.

7.2 The Seller warrants that on Completion:

- 7.2.1 the Seller will be or will be able to be the registered proprietor of the Lease and will own the rest of the Property free from any Affecting Interests;
- 7.2.2 the Seller will have the capacity to complete;
- 7.2.3 there will be no unsatisfied judgment, order or writ affecting the Property;
- 7.2.4 the Seller has no knowledge of any current or threatened claims, notices or proceedings that may lead to a judgment, order or writ affecting the Property;
- 7.2.5 the Seller is not aware of any encroachments by or upon the Property except as disclosed. This warranty does not extend to the location of any dividing fence;
- 7.2.6 there will be no Breach of Covenant except as disclosed in this Contract; and
- 7.2.7 unless disclosed in the Schedule or elsewhere in this Contract, the Lease is a

Non-Land Rent Lease and not a Land Rent Lease.

- 7.3 The Seller gives no warranties as to the present state of repair of any of the Improvements or condition of the Land, except as required by law.

8. Adjustments

- 8.1 The Seller is entitled to the Income and is liable for all Land Charges up to and including Completion after which the Buyer will be entitled to the Income and liable for the Land Charges, provided the Seller will be liable for all land tax in respect of the Property if the 'Land Tax to be adjusted?' option on the Schedule is marked 'No'.
- 8.2 The parties must pay any adjustment of the Income and Land Charges calculated under clause 8.1 on Completion.
- 8.3 Any concessional Land Charges must be adjusted on the concessional amount of those Land Charges.
- 8.4 If any of the Land Charges have not been assessed on Completion, the Buyer will be entitled to retain in the Buyer Solicitor trust account from the Balance of the Price an amount sufficient to pay the Seller's proportion of those Land Charges.
- 8.5 Attached are copies of the relevant invoices for the cost of obtaining the Building and Compliance Inspection Report and Pest Inspection Report. The Buyer must pay to the Seller the cost of obtaining the Building and Compliance Inspection Report and the Pest Inspection Report as required by section 18 of the Sale of Residential Property Act on Completion.

9. Terms of possession

- 9.1 The Seller must give the Buyer vacant possession of the Property on Completion unless otherwise marked in the Schedule.
- 9.2 If the Property is sold subject to a tenancy, the Seller has:
 - 9.2.1 attached to this Contract a copy of the signed Tenancy Agreement; or
 - 9.2.2 completed the tenancy summary on page 2 of this Contract.
- 9.3 If the Property is sold subject to a tenancy:
 - 9.3.1 the Seller warrants that except as disclosed in this Contract:
 - (a) if applicable, the rental bond has been provided in accordance with the Residential Tenancies Act;
 - (b) if applicable, the Seller has complied with the Residential Tenancies Act;

- (c) if applicable, the Seller has no notice of any application by the tenant for the release of the rental bond;
- (d) no notices relating to the tenancy have been served on the Seller or any agent of the Seller or on the tenant other than as disclosed in this Contract and there are no outstanding claims or disputes with the tenant;
- (e) there is no unremedied breach of the Tenancy Agreement by the tenant or the Seller; and
- (f) if applicable, the Tenancy Agreement incorporates:
 - (i) the Prescribed Terms; and
 - (ii) any other terms approved by the Residential Tenancies Tribunal.

9.3.2 The Seller must hand to the Buyer on Completion:

- (a) any written Tenancy Agreement to which this Contract is subject;
- (b) a notice of attornment;
- (c) if applicable, any notice required to be signed by the Seller to transfer the rental bond by the Office of Rental Bonds to the Buyer; and
- (d) if applicable, any other notice required to be signed by the Seller under the Residential Tenancies Act.

9.3.3 The Buyer indemnifies the Seller in relation to any liability which the Seller incurs or to which the Seller is subject under the tenancy because of matters occurring after Completion.

10. Inspection and condition of Property

- 10.1 The Buyer may on reasonable notice to the Seller and at reasonable times inspect the Property before Completion.
- 10.2 The Seller must leave the Property clean and tidy on Completion.

11. Inspection of building file

- 11.1 The Seller must, if requested by the Buyer, give to the Buyer all authorities necessary to enable the Buyer (or Buyer's nominee) to inspect and obtain at the Buyer's expense, copies of:
 - 11.1.1 any document in relation to the Land and Improvements held by any government or statutory authority; and

- 11.1.2 any notices issued by any authority in relation to the Land and Improvements.

12. Additional Seller obligations

- 12.1 Except for any Breach of Covenant disclosed in this Contract, the Seller must before Completion:
 - 12.1.1 comply with any notice issued by any authority before the Date of this Contract which requires work to be done or money to be spent on or in relation to the Property or the Lease;
 - 12.1.2 obtain approval for any Development conducted on the Land;
 - 12.1.3 comply with the Lease to the extent to which the Seller is required to comply up to Completion;
 - 12.1.4 comply with any obligations on the Seller in a registered restrictive covenant affecting the Lease; and
 - 12.1.5 give the Buyer notice of any material change (other than fair wear and tear) the Seller becomes aware of in the matters disclosed in the Required Documents, since the date of each of the relevant Required Documents.

13. Electronic transaction

- 13.1 In this clause 13, the following words mean:

Adjustment Figures mean details of the adjustments to be made to the Price under this Contract;

Completion Time means the time of day on the Date for Completion when the Electronic Transaction is to be Completed;

Conveyancing Transaction has the meaning given in the Participation Rules;

Digitally Signed has the meaning given in the Participation Rules and **Digitally Sign** has a corresponding meaning;

Discharging Mortgagee means any discharging mortgagee, chargee, covenant chargee or caveator whose provision of a Digitally Signed discharge of mortgage, discharge of charge or withdrawal of caveat is required in order for unencumbered title to the Lease to be transferred to the Buyer;

ECNL means the *Electronic Conveyancing National Law (ACT) Act 2020 (ACT)*;

Effective Date means the date on which the Conveyancing Transaction is agreed to be an Electronic Transaction under clause 13.2.2 or, if clause 13.2.1 applies, the Date of this Contract;

Electronic Document means a caveat, a Crown lease or an instrument as defined in the Land Titles Act which may be created and Digitally Signed in an Electronic Workspace;

Electronic Transaction means a Conveyancing Transaction to be conducted for the parties by their legal representatives as Subscribers using an ELN and in accordance with the ECNL and the Participation Rules;

Electronic Transfer means a transfer of the Lease under the Land Titles Act to be prepared and Digitally Signed in the Electronic Workspace established for the purposes of the parties' Conveyancing Transaction;

Electronic Workspace has the meaning given in the Participation Rules;

Electronically Tradeable means a land title dealing that can be lodged electronically;

ELN has the meaning given in the Participation Rules;

FRCGW Remittance means a remittance which the Buyer must make in accordance with the Withholding Law and clauses 51.4 to 51.8;

GSTRW Payment means a payment which the Buyer must make in accordance with the Withholding Law and clauses 53.5 to 53.9;

Incoming Mortgagee means any mortgagee who is to provide finance to the Buyer on the security of the Lease and to enable the Buyer to pay the whole or part of the price;

Land Registry has the meaning given in the Participation Rules;

Lodgment Case has the meaning given in the Participation Rules;

Mortgagee Details mean the details which a party to the Electronic Transaction must provide about any Discharging Mortgagee of the Land as at Completion;

Nominated ELN means the ELN specified in the Schedule;

Participation Rules mean the participation rules as determined by the ECNL;

Populate means to complete data fields in the Electronic Workspace;

Prescribed Requirement has the meaning given in the Participation Rules;

Subscribers has the meaning given in the Participation Rules; and

Title Data means the details of the title to the Lease made available to the Electronic Workspace by the Land Registry.

- 13.2 This Conveyancing Transaction is to be conducted as an Electronic Transaction and this Contract is amended as required if:
- 13.2.1 this Contract says that it is an Electronic Transaction; or
- 13.2.2 the parties otherwise agree that it is to be conducted as an Electronic Transaction.
- 13.3 However, this Conveyancing Transaction is not to be conducted as an Electronic Transaction:
- 13.3.1 if the title to the Lease is not Electronically Tradeable or the transfer of the Lease is not eligible to be lodged electronically; or
- 13.3.2 if, at any time after the Effective Date, but at least 14 days before the Date for Completion, a party serves a notice on the other party stating a valid reason why it cannot be conducted as an Electronic Transaction.
- 13.4 If, because of clause 13.3.2, this Conveyancing Transaction is not to be conducted as an Electronic Transaction:
- 13.4.1 each party must:
- (a) bear equally any disbursements or fees; and
- (b) otherwise bear that party's own costs; incurred because this Conveyancing Transaction was to be conducted as an Electronic Transaction; and
- 13.4.2 if a party has paid all of a disbursement or fee which by reason of this clause, is to be borne equally by the parties, that amount must be adjusted on Completion.
- 13.5 If this Conveyancing Transaction is to be conducted as an Electronic Transaction:
- 13.5.1 to the extent that any other provision of this Contract is inconsistent with this clause, the provisions of this clause prevail and this Contract is amended to give full effect to the Electronic Transaction;
- 13.5.2 without limiting clause 13.5.1, clause 5.2 does not apply;
- 13.5.3 the parties must conduct the Electronic Transaction:
- (a) in accordance with the Participation Rules and the ECNL; and
- (b) using the Nominated ELN, unless the parties otherwise agree;
- 13.5.4 a party must pay the fees and charges payable by that party to the ELN and the

- Land Registry as a result of this transaction being an Electronic Transaction; and
- 13.5.5 a document which is an Electronic Document is served as soon as it is first Digitally Signed in the Electronic Workspace on behalf of the party required to serve it.
- 13.6 The Seller must within 7 days of the Effective Date:
- 13.6.1 create an Electronic Workspace;
- 13.6.2 Populate the Electronic Workspace with Title Data, the Date for Completion and, if applicable, Mortgagee Details; and
- 13.6.3 invite the Buyer and any Discharging Mortgagee to the Electronic Workspace.
- 13.7 If the Seller has not created an Electronic Workspace in accordance with clause 13.6, the Buyer may create an Electronic Workspace. If the Buyer creates the Electronic Workspace the Buyer must:
- 13.7.1 Populate the Electronic Workspace with Title Data;
- 13.7.2 create and Populate the Electronic Transfer;
- 13.7.3 Populate the Electronic Workspace with the Date for Completion and a nominated Completion Time; and
- 13.7.4 invite the Seller and any Incoming Mortgagee to join the Electronic Workspace.
- 13.8 Within 7 days of receiving an invitation from the Seller to join the Electronic Workspace, the Buyer must:
- 13.8.1 join the Electronic Workspace;
- 13.8.2 create and Populate the Electronic Transfer;
- 13.8.3 invite any Incoming Mortgagee to join the Electronic Workspace; and
- 13.8.4 Populate the Electronic Workspace with a nominated Completion Time.
- 13.9 If the Buyer has created the Electronic Workspace the Seller must within 7 days of being invited to the Electronic Workspace:
- 13.9.1 join the Electronic Workspace;
- 13.9.2 Populate the Electronic Workspace with Mortgagee Details, if applicable; and
- 13.9.3 invite any Discharging Mortgagee to join the Electronic Workspace.
- 13.10 To complete the financial settlement schedule in the Electronic Workspace:
- 13.10.1 the Seller must provide the Buyer with Adjustment Figures at least 2 Business Days before the Date for Completion;
- 13.10.2 the Buyer must confirm the Adjustment Figures at least 1 Business Day before the Date for Completion; and
- 13.10.3 if the Buyer must make a GSTRW Payment and / or an FRCGW Remittance, the Buyer must Populate the Electronic Workspace with the payment details for the GSTRW Payment or FRCGW Remittance payable to the ATO at least 2 Business Days before the Date for Completion.
- 13.11 Before Completion, the parties must ensure that:
- 13.11.1 all Electronic Documents which a party must Digitally Sign to complete the Electronic Transaction are Populated and Digitally Signed;
- 13.11.2 all certifications required by the ECNL are properly given; and
- 13.11.3 they do everything else in the Electronic Workspace which that party must do to enable the Electronic Transaction to proceed to Completion.
- 13.12 If Completion takes place in the Electronic Workspace:
- 13.12.1 payment electronically on Completion of the Balance of the Price in accordance with clause 2.6 is taken to be payment by a single unendorsed bank cheque; and
- 13.12.2 clauses 51.4.3, 51.4.4, 53.8 and 53.9 do not apply.
- 13.13 If the computer systems of any of the Land Registry, the ELN, the ATO or the Reserve Bank of Australia are inoperative for any reason at the Completion Time agreed by the parties, a failure to complete this Contract for that reason is not a default under this Contract on the part of either party.
- 13.14 If the computer systems of the Land Registry are inoperative for any reason at the Completion Time agreed by the parties, and the parties agree that financial settlement is to occur despite this, then on financial settlement occurring:
- 13.14.1 all Electronic Documents Digitally Signed by the Seller, any discharge of mortgage, withdrawal of caveat or other Electronic Document forming part of the Lodgment Case for the Electronic Transaction shall be taken to have been unconditionally and irrevocably delivered to the Buyer or

the Buyer's mortgagee at the time of financial settlement; and

13.14.2 the Seller shall be taken to have no legal or equitable interest in the Property.

13.15 If the parties do not agree about the delivery before Completion of one or more documents or things that cannot be delivered through the Electronic Workspace, the party required to deliver the documents or things:

13.15.1 holds them on Completion in escrow for the benefit of the other party; and

13.15.2 must immediately after Completion deliver the documents or things to, or as directed by the party entitled to them.

14. Off the plan purchase and Compliance Certificate

14.1 If the Lease contains a Building and Development Provision which has not been complied with at the Date of this Contract, and clause 4.2 does not apply:

14.1.1 where the Seller is obliged to construct Improvements by Completion, before the Date for Completion, the Seller must at the Seller's expense complete the construction of the Improvements promptly and in a good and workmanlike manner substantially in accordance with the proposed plan, specifications and inclusions list attached; and

14.1.2 on or before Completion, the Seller must at the Seller's expense give to the Buyer evidence that a Compliance Certificate has been obtained.

15. Goods

15.1 The Seller gives no warranties as to the present state of repair of any of the Goods except as required by law.

15.2 The Goods are included in the Price.

15.3 The Seller warrants that the Goods are unencumbered and that the Seller has the right to sell them.

15.4 The Goods become the Buyer's property on Completion.

15.5 Except for fair wear and tear, the Seller must give the Goods to the Buyer on Completion in the same state of repair they are in at the Date of this Contract.

16. Errors and misdescriptions

16.1 If, before Completion, the Buyer becomes aware of an error in the description of the Property the Buyer may:

16.1.1 identify whether the error is material or not material, and ask the Seller to arrange for the error to be corrected before Completion; and

16.1.2 if the error is not corrected before Completion:

(a) for an error that is material — rescind this Contract, or complete this Contract and make a claim for compensation; and

(b) for an error that is not material — complete this Contract and make a claim for compensation.

16.2 This clause applies even if the Buyer did not take notice of or rely on anything in this Contract containing or giving rise to the error or misdescription.

16.3 The Buyer is not entitled to compensation to the extent the Buyer knew the true position before the Date of this Contract.

17. Compensation claims by Buyer

17.1 To make a claim for compensation (including a claim under clause 16) the Buyer must give notice to the Seller before Completion specifying the amount claimed and:

17.1.1 the Seller can rescind if in the case of a claim that is not a claim for delay:

(a) the total amount claimed exceeds 5% of the Price;

(b) the Seller gives notice to the Buyer of an intention to rescind; and

(c) the Buyer does not give notice to the Seller waiving the claim within 14 days after receiving the notice; and

17.1.2 if the Seller does not rescind under clause 17.1.1, the parties must complete and:

(a) the lesser of the total amount claimed and 5% of the Price must be paid out of the Price to, and held by, the Stakeholder until the claim is finalised or lapses;

(b) the amount held is to be invested by the Stakeholder (at the risk of the party who becomes entitled to it) with an Australian bank in an interest-bearing account at call in the name of

- the Stakeholder in trust for the Seller and the Buyer;
- (c) the claim must be finalised by an arbitrator appointed by the parties or, if an appointment is not made within 28 days of Completion, by an arbitrator appointed by the President of the Law Society of the Australian Capital Territory at the request of a party;
 - (d) the decision of the arbitrator is final and binding;
 - (e) the costs of the arbitration must be shared equally by the parties unless otherwise determined by the arbitrator. For clarity, the arbitrator has the power to award indemnity costs on a legal basis against either party;
 - (f) the Buyer is not entitled, in respect of the claim, to more than the total amount claimed and the costs of the Buyer;
 - (g) interest on the amount held, after deduction of all taxes and bank charges, Stakeholder administration fee and other similar charges and expenses, must be paid to the parties equally or as otherwise determined by the arbitrator; and
 - (h) the claim lapses if the parties do not appoint an arbitrator and neither party asks the President of the Law Society of the Australian Capital Territory to appoint an arbitrator within 90 days after Completion and the amount held by the Stakeholder must be paid immediately to the Seller without any further authority being necessary.
- 18.3.2 be ready willing and able to complete but for some default or omission of the other party.
- 18.4 Completion at the time date and place specified in the Notice to Complete is an essential term.
- 18.5 Where one party is in default (other than failing to complete) the other party may at any time after the default serve the party in default a Default Notice.
- 18.6 A Default Notice:
- 18.6.1 must specify the default;
 - 18.6.2 must require the party served with the Default Notice to rectify the default within 7* days after service of the Default Notice (excluding the date of service), except in the case of a Default Notice for the purposes of clause 52.6, in which case the period specified in clause 52.6 will apply; and
 - 18.6.3 cannot be used to require a party to complete this Contract.
- 18.7 At the time the Default Notice is served, the party serving the Default Notice must not be in default.
- 18.8 The time specified in a Default Notice to rectify the specified default is an essential term.
- 18.9 Clauses 19 or 20 will apply as appropriate where the party served does not comply with the Notice to Complete or the Default Notice which complies with this clause.
- 18.10 If the party serving a notice under this clause varies the time referred to in the notice at the request of the other party, the time agreed to in the variation remains an essential term. The consent to the variation must be in writing and be served on the other party.
- 18.11 The parties agree that the time referred to in clauses 18.2 and 18.6.2 is fair and reasonable.

18. Notice to Complete and Default Notice

- 18.1 If Completion does not take place in accordance with clause 2.8, either party may, at any time after the Date for Completion, serve the other party a Notice to Complete.
- 18.2 A Notice to Complete must appoint a time during business hours and a date being not less than 14* days after service of the Notice to Complete (excluding the date of service) by which and a place in Canberra at which to complete this Contract.
- 18.3 At the time the Notice to Complete is served the party serving the Notice to Complete must:
- 18.3.1 not be in default; and

19. Termination — Buyer default

- 19.1 If the Buyer does not comply with a Notice to Complete or a Default Notice or is otherwise in breach of an essential term then the Seller may by notice served on the Buyer terminate and may then keep, or recover and keep, the Deposit (except so much of it as exceeds 10% of the Price) and either:
- 19.1.1 sue the Buyer for breach; or
 - 19.1.2 resell the Property and any deficiency arising on the resale and all expenses of and incidental to the resale or attempted resale and the Buyer's default are

* Alter as necessary

recoverable by the Seller from the Buyer as liquidated damages provided the Seller has entered into a contract for the resale of the Property within 12 months of termination.

- 19.2 In addition to any money kept or recovered under clause 19.1, the Seller may retain on termination any other money paid by the Buyer as security for any damages awarded to the Seller arising from the Buyer's default provided that proceedings for the recovery of damages are commenced within 12 months of termination.

20. Termination – Seller default

- 20.1 If the Seller does not comply with a Notice to Complete or a Default Notice or is otherwise in breach of an essential term the Buyer may by notice served on the Seller either:

- 20.1.1 terminate and seek damages; or
- 20.1.2 enforce without further notice any other rights and remedies available to the Buyer.

- 20.2 If the Buyer terminates, the Stakeholder is authorised to refund to the Buyer immediately any money paid on account of the Price.

21. Rescission

- 21.1 Unless section 15 of the Sale of Residential Property Act applies, if this Contract is rescinded, it is rescinded from the beginning, and unless the parties otherwise agree:

- 21.1.1 the Deposit and all other money paid by the Buyer must be refunded to the Buyer immediately without any further authority being necessary; and
- 21.1.2 neither party is liable to pay the other any amount for damages, costs or expenses.

22. Damages for delay in Completion

- 22.1 If Completion does not occur by the Date for Completion, due to the default of either party, the party who is at fault must pay the other party as liquidated damages on Completion:

- 22.1.1 if the defaulting party is the Seller, interest on the Price at the rate this Contract says on page 2, calculated on a daily basis from the date 7 days after the Date for Completion to Completion;
- 22.1.2 if the defaulting party is the Buyer, interest on the Price at the rate this Contract says on page 2, calculated on a daily basis from the date 7 days after the Date for Completion to Completion; and
- 22.1.3 the amount this Contract says on page 2 to be applied towards any legal costs and disbursements incurred by the party not

at fault if Completion occurs later than 7 days after the Date for Completion.

- 22.2 Whether or not percentages are inserted in clauses 22.1.1 or 22.1.2 the party at fault must pay the amount specified in clause 22.1.3 in addition to any other damages to which the party not at fault is entitled both at law and under this Contract.

- 22.3 The parties agree that:

- 22.3.1 the amount of any damages payable under clause 22.1.1 or clause 22.1.2 to the party not in default is a genuine and honest pre-estimate of loss to that party for the delay in Completion, and
- 22.3.2 the damages must be paid on Completion.

23. Foreign Buyer

- 23.1 The Buyer warrants the Commonwealth Treasurer cannot prohibit and has not prohibited the transfer of the Lease under the *Foreign Acquisitions and Takeovers Act 1975* (Cth).

- 23.2 This clause is an essential term.

24. GST

- 24.1 If a party must pay the Price or provide any other consideration to another party under this Contract, GST is not to be added to the Price or amount, unless this Contract provides otherwise.

- 24.2 If the Price is stated in the Schedule to exclude GST and the sale of the Property is a taxable supply, the Buyer must pay to the Seller on Completion an amount equal to the GST payable by the Seller in relation to the supply.

- 24.3 If under this Contract a party (Relevant Party) must make an adjustment, pay an amount to another party (excluding the Price but including the Deposit if it is released or forfeited to the Seller) or pay an amount payable by or to a third party:

- 24.3.1 the Relevant Party must adjust or pay at that time any GST added to or included in the amount; but
- 24.3.2 if this Contract says this sale is a taxable supply, and payment would entitle the Relevant Party to claim an input tax credit, the adjustment or payment is to be worked out by deducting any input tax credit to which the party receiving the adjustment or payment is or was entitled multiplied by the GST Rate.

- 24.4 If this Contract says this sale is the supply of a going concern:

- 24.4.1 the parties agree the supply of the Property is the supply of a going concern;
- 24.4.2 the Seller must on Completion supply to the Buyer all of the things that are necessary for the continued operation of the enterprise;
- 24.4.3 the Seller must carry on the enterprise until Completion;
- 24.4.4 the Buyer warrants to the Seller that on Completion the Buyer will be registered or required to be registered; and
- 24.4.5 if for any reason (and despite clauses 24.1 and 24.4.1) the sale of the Property is not the supply of a going concern but is a taxable supply:
 - (a) the Buyer must pay to the Seller on demand the amount of any GST payable by the Seller in respect of the sale of the Property; and
 - (b) the Buyer indemnifies the Seller against any loss or expense incurred by the Seller in respect of that GST and any breach of clause 24.4.5(a).
- 24.5 If this Contract says the margin scheme applies:
 - 24.5.1 the Seller warrants that it can use the margin scheme; and
 - 24.5.2 the Buyer and Seller agree that the margin scheme is to apply, in respect of the sale of the Property.
- 24.6 If this Contract says the sale is a taxable supply, does not say the margin scheme applies to the sale of the Property, and the sale is in fact not a taxable supply, then the Seller must pay the Buyer on Completion an amount of one-eleventh of the Price.
- 24.7 Unless the margin scheme applies the Seller must, on Completion, give the Buyer a tax invoice for any taxable supply by the Seller by or under this Contract.

25. Power of attorney

- 25.1 Any party who signs this Contract or any document in connection with it under a power of attorney must, on request and without cost, provide the other party with a true copy of the registered power of attorney.

26. Notices claims and authorities

- 26.1 Notices, claims and authorities required or authorised by this Contract must be in writing.
- 26.2 To serve a notice a party must:
 - 26.2.1 leave it at; or

- 26.2.2 send it by a method of post requiring acknowledgment of receipt by the addressee to, the address of the person to be served as stated in the Schedule or as notified by that person to the other as that person's address for service under this Contract; or
- 26.2.3 serve it on that party's solicitor in any of the above ways; or
- 26.2.4 deliver it to an appropriate place in the facilities of a document exchange system in which the recipient solicitor has receiving facilities (and in the latter case service is deemed effected on the Business Day following delivery); or
- 26.2.5 transmit it by email to a party's solicitor to the email address for that solicitor as stated in the Schedule or as notified by that solicitor to the other solicitor as the email address for service under this Contract.
- 26.3 A party's solicitor may give a notice, claim or authority on behalf of that party.

27. Unit title

- 27.1 The following clauses 28 to 39 inclusive apply if the Property is a Unit.

28. Definitions and interpretation

- 28.1 A reference in these clauses 28 to 39 inclusive to a section or Part is a reference to a section or Part of the Unit Titles Management Act.
- 28.2 For the purposes of a claim for compensation pursuant to clause 39, the provisions of clause 17 will apply provided that clause 17.1.1(c) is amended to read "the Buyer does not give notice to the Seller waiving the claim, or so much of it as exceeds 5% of the Price within 14 days after receiving the notice".

29. Title to the Unit

- 29.1 Clauses 3.1, 3.2 and 3.3 do not apply.
- 29.2 The Unit Title is or will before Completion be granted under the Planning Act and is or will before Completion be registered under the *Land Titles (Unit Titles) Act 1970 (ACT)*.
- 29.3 The Unit Title is transferred subject to the Units Plan under which the lease to the Unit is held.

30. Buyer rights limited

- 30.1 In addition to clause 6, the Buyer cannot make any requisition on title or make a claim for compensation in respect of any Breach of Covenant of the Unit Title, any breach of the

lease of the Common Property or breach of rules of the Owners Corporation disclosed in this Contract.

31. Adjustment of contribution

31.1 Any adjustment under clause 8 must include an adjustment of the contributions to the Owners Corporation under section 78 and section 89 of the Unit Titles Management Act.

32. Inspection of Unit

32.1 For the purposes of clause 10.1 Property includes the Common Property.

33. Seller warranties

33.1 The Seller warrants that at the Date of this Contract:

33.1.1 to the Seller's knowledge, there are no unfunded latent or patent defects in the Common Property or Owners Corporation assets, other than the following:

- (a) defects arising through fair wear and tear; and
- (b) defects disclosed in this Contract;

33.1.2 the Owners Corporation records do not disclose any defects to which the warranty in clause 33.1.1 applies;

33.1.3 to the Seller's knowledge, there are no actual, contingent or expected unfunded liabilities of the Owners Corporation that are not part of the Owners Corporation's normal operating expenses, other than liabilities disclosed in this Contract;

33.1.4 the Owners Corporation records do not disclose any liabilities of the Owners Corporation to which the warranty in clause 33.1.3 applies;

33.1.5 the Seller or any occupier of the Unit has not committed any act or omission which may cause the Owners Corporation to incur any costs or perform any repairs;

33.1.6 there is no amount payable to the Owners Corporation by the Seller other than a contribution due under section 78 and section 89 of the Unit Titles Management Act; and

33.1.7 except for an unregistered Units Plan, the rules of the Owners Corporation are, as appropriate:

- (a) as set out in Schedule 4 to the Unit Titles Management Act; or

(b) in respect of a corporation established under the *Unit Titles Act 1970* (*repealed*) and that was in existence immediately prior to 30 March 2012, the articles in force immediately prior to 30 March 2012; or

(c) in respect of a corporation established under the Unit Titles Act and that was in existence immediately prior to 30 March 2012, the articles in force immediately prior to 30 March 2012;

except for any alterations to those rules registered under section 108.

33.2 For clauses 33.1.1 to 33.1.4 inclusive, a Seller is taken to have knowledge of a thing if the Seller has actual knowledge, or ought reasonably to have knowledge, of that thing.

33.3 The Seller warrants that at Completion to the Seller's knowledge, there are no circumstances (other than circumstances disclosed in this Contract) in relation to the affairs of the Owners Corporation likely to significantly prejudice the Buyer.

33.4 For the purposes of clause 7, Property includes the Common Property.

33.5 These warranties are in addition to those given in clause 7.

34. Damage or destruction before Completion

34.1 If the Unit is destroyed or substantially damaged before Completion not due to the fault of either party then either party may by notice to the other rescind and clause 21 applies.

34.2 For the purposes of clause 34.1, the Unit is deemed to be substantially damaged if though not destroyed is unfit for the use to which it was being put at the Date of this Contract or, if not being used at that time, for the purpose permitted by the Unit Title.

35. Notice to Owners Corporation

35.1 The parties must comply with the rules of the Owners Corporation in relation to notification of the sale and purchase of the Unit.

36. Unit Title Certificate

36.1 On Completion the Buyer must pay to the Seller the fee as determined by the Minister pursuant to section 119(7) of the Units Title Management Act for the Unit Title Certificate attached.

37. Unregistered Units Plan

Warning: The following clauses 37, 38 and 39 do not encompass all obligations, rights and remedies under Part 2.9 of the Property Act for off the plan contracts.

- 37.1 This clause 37 applies if at the Date of this Contract, the Units Plan has not been registered.
- 37.2 The Seller must attach a copy of the proposed Units Plan or a sketch plan showing the location and dimensions of the Unit sufficient to enable the Buyer to determine the location and dimensions of the Unit in relation to other units and the Common Property in the proposed development.
- 37.3 If the Units Plan is not registered by the date specified in the Schedule, or elsewhere in this Contract, the Buyer may at any time after that date by notice served on the Seller require that the Units Plan be registered within 14 days of the service of the notice. If the Units Plan is not registered within the time limited by the notice the Buyer may at any time after expiry of the time in the notice rescind and clause 21 will apply.
- 37.4 If the Seller notifies the Buyer that the Units Plan is registered before rescission under this clause, the Buyer will not be entitled to rescind under this clause.
- 37.5 The Buyer cannot make any objection or requisition on title or claim for compensation in respect of:
- 37.5.1 any minor variations to the Unit between the plan attached, and the Units Plan registered by the Registrar General; or
- 37.5.2 any minor alterations required by an authority or the Registrar General in the number, size, location or Unit Entitlement of any other unit in the Units Plan or in or to the Common Property provided the proportion of the Unit Entitlement of the Unit to the other units in the Units Plan is not varied.
- In this clause, a minor variation is any variation less than 5% to either the size or value of the Unit described in the plan attached.
- 37.6 After the Owners Corporation has been constituted under section 8, the Seller must cause the Owners Corporation to comply with the rules of the Owners Corporation and with Parts 2, 3, 4, 5 and 7 to the extent to which the Owners Corporation is required by law to comply with those provisions up to the Date for Completion.
- 37.7 The Seller must not permit the Owners Corporation to vary the rules of the Owners

Corporation from those set out in Schedule 4 of the Unit Title Management Act.

- 37.8 If clause 37.1 applies, the Seller must give to the Buyer a Unit Title Certificate at the Buyer's expense at least 7 days before Completion.
- 37.9 The parties acknowledge that the following must form part of the Contract:
- 37.9.1 a Disclosure Statement for the Unit that complies with the requirements of section 260 of the Property Act; and
- 37.9.2 if a right to approve the keeping of animals during the Developer Control Period is reserved — details of the reservation, including the kind and number of animals.
- 37.10 The Seller warrants that the information disclosed in the Disclosure Statement, including information in any Disclosure Update Notice, is accurate.

38. Rescission of Contract

- 38.1 The Buyer may, by written notice given to the Seller, rescind this Contract if:
- 38.1.1 there would be a breach of a warranty provided in any of clauses 33.1.1, 33.1.2, 33.1.3, 33.1.4 or 33.3, were this Contract completed at the time it is rescinded; or
- 38.1.2 there would be a breach of a warranty provided in clause 37.10:
- (a) were this Contract completed at the time it is rescinded; and
- (b) the Buyer is significantly prejudiced by the breach,
- and the breach does not relate to an amendment to the Development Statement that is an Excluded Change.
- 38.2 A notice must be given:
- 38.2.1 under clause 38.1.1:
- (a) if this Contract is entered before the Units Plan for the Unit is registered — not later than 3 days before the Buyer is required to complete this Contract; or
- (b) in any other case — not later than 14 days after the later of the following happens:
- (i) the Date of this Contract; and
- (ii) another period agreed between the Buyer and Seller ends; or

38.2.2 under clause 38.1.2 – at any time before the Buyer is required to complete this Contract.

38.3 If the Buyer rescinds this Contract, the Seller must repay any amount paid to the Seller towards the purchase of the Unit and otherwise the provisions of clause 21 will apply.

39. Claims for compensation

39.1 This clause 39 applies if, before Completion, the Buyer reasonably believes that, except as disclosed in this Contract, there would be a breach of a warranty established under any of clauses 33.1.1, 33.1.2, 33.1.3, 33.1.4, 33.3 or 37.10 were this Contract to be completed.

39.2 The Buyer may, by written notice given to the Seller:

39.2.1 tell the Seller:

- (a) about the breach; and
- (b) that the Buyer will complete this Contract; and

39.2.2 claim compensation for the breach.

39.3 A notice under clause 39.2 must be given:

39.3.1 if this Contract is entered before the Units Plan for the Unit is registered – not later than 3 days before the Buyer is required to complete this Contract; or

39.3.2 in any other case – not later than 14 days after the later of the following happens:

- (a) the Buyer's copy of the Contract is received by the Buyer;
- (b) another period agreed between the Buyer and Seller ends.

39.4 The Buyer may not claim compensation under this clause 39 only because of the breach of a warranty related to an amendment to the Development Statement that is an Excluded Change.

40. Community title

40.1 The following clauses 41 to 50 inclusive apply if the Property is, or will on Completion form, a Lot within a Community Title Scheme.

41. Definitions and interpretation

41.1 A reference in these clauses 40 to 50 inclusive to a section or Part is a reference to a section or Part of the Community Title Act.

42. Buyer rights limited

42.1 In addition to clause 6, the Buyer cannot make any requisition on title or make a claim for

compensation in respect of any breach of the lease of the Common Property or breach of rules or by-laws of the Community Title Body Corporate disclosed in this Contract.

43. Adjustment of contribution

43.1 Any adjustment under clause 8 must include an adjustment of the contributions to the fund under section 45.

44. Inspection of property

44.1 For the purposes of clause 10.1 Property includes the Common Property.

45. Unregistered Community Title Scheme

45.1 This clause 45 applies if at the Date of this Contract, the Community Title Scheme has not registered.

45.2 The Seller must attach a copy of the proposed Community Title Master Plan, or a sketch plan showing the location and dimensions of the Lot sufficient to enable the Buyer to determine the location and dimensions of the Lot in relation to other lots and the Common Property in the proposed scheme.

45.3 The Seller must attach a copy of the proposed Community Title Management Statement.

45.4 The Buyer cannot make any objection or requisition on title or claim for compensation in respect of:

45.4.1 any minor variations to the Lot between the plan attached, and the registered Community Title Master Plan; or

45.4.2 any minor alterations required by an authority or the Registrar General in the number, size, location or entitlement of any other Lot in the Community Title Scheme or in or to the Common Property provided the proportion of the entitlement of the Lot to the other lots in the Community Title Scheme is not varied; or

45.4.3 any minor variations between the proposed Community Title Management Statement and the registered Community Title Management Statement.

In this clause, a minor variation is any variation less than 5% to either the size or value of the Lot described in the plan attached and referred to in the proposed Community Title Management Statement.

45.5 The Seller must not permit the Community Title Body Corporate to vary the by-laws of the

Community Title Scheme from those set out in Schedule 1 of the Community Title Act, unless otherwise disclosed in this Contract.

- 45.6 After the Community Title Body Corporate has been constituted under section 30, the Seller must cause the Community Title Body Corporate to comply with Part 8 to the extent to which the Community Title Body Corporate is required by law to comply with those provisions up to the Date for Completion.

46. Incomplete development of Community Title Scheme

- 46.1 This clause 46 applies if at the Date of this Contract, development of the Community Title Scheme has not completed.
- 46.2 Until the development of a Community Title Scheme is finished, the Developer warrants to the Buyer that the development will be carried out in accordance with the scheme.
- 46.3 Without limiting the damages recoverable for breach of the warranty in clause 46.2, the Buyer may recover damages for the loss of a reasonably expected capital appreciation of the Lot that would have resulted from completion of the development in accordance with the terms of the Community Title Scheme.

47. Incomplete development of Lot

- 47.1 This clause 47 applies if at the Date of this Contract, the Lot is to be developed or further developed in accordance with the Community Title Scheme. For clarity, this clause does not apply if an unconditional Compliance Certificate has issued before the Date of this Contract and the Seller gives to the Buyer evidence acceptable to the Registrar General that an unconditional Compliance Certificate has issued for the Lot, or if the Seller gives an unconditional Compliance Certificate to the Buyer on Completion.
- 47.2 The Buyer becomes bound to develop the Lot in accordance with the Community Title Scheme.
- 47.3 The Seller must give written notice of the proposed sale of the Lot to the Planning and Land Authority.
- 47.4 The Buyer must:
- 47.4.1 give to the Planning and Land Authority a written undertaking to develop the Lot in accordance with the Community Title Scheme (if a form is approved for an undertaking, the form must be used); and
- 47.4.2 give the Planning and Land Authority any security required by the Planning and Land Authority, within 28 days after notice of the transaction was given to the

Planning and Land Authority, for the development of the Lot in accordance with the Community Title Scheme.

48. Required first or top sheet

- 48.1 The Seller must give to the Buyer, before the Buyer enters into this Contract, a Section 67 Statement.
- 48.2 The Section 67 Statement must:
- 48.2.1 state that the Lot is included in a Community Title Scheme that imposes obligations on the owner of the Lot;
- 48.2.2 state the name and address of:
- (a) the body corporate of the scheme; or
- (b) if it is the duty of the Community Title Body Corporate manager to act for the Community Title Body Corporate in supplying Section 56 Certificates – the manager;
- 48.2.3 state the amount of annual contributions currently fixed by the Community Title Body Corporate as payable by the owner of the Lot;
- 48.2.4 identify improvements on common property of the scheme for which the owner of the Lot is responsible;
- 48.2.5 be signed by the Seller or a person authorised by the Seller; and
- 48.2.6 be substantially complete.
- 48.3 The Seller must attach to this Contract, as a first or top sheet, a copy of the Section 67 Statement given to the Buyer under clause 48.1.
- 48.4 The Buyer may rescind this Contract if:
- 48.4.1 the Seller has not complied with clauses 48.1 and 48.3; and
- 48.4.2 Completion has not taken place.

49. Notice to Community Title Body Corporate

- 49.1 The parties must comply with the rules and by-laws of the Community Title Body Corporate in relation to notification of the sale and purchase of the Lot.

50. Section 56 Certificate

- 50.1 The Seller must give to the Buyer a Section 56 Certificate at least 7 days before Completion.
- 50.2 On Completion, the Buyer must pay to the Seller the fee charged for the Section 56 Certificate.

51. Foreign Resident Withholding Tax

Warning: The questions in the Schedule regarding the Relevant Price and the Clearance Certificates are not binding, and are included to remind the parties of their obligations under the Withholding Law.

Warning: The following clauses 51.1 to 51.8 are subject to the Withholding Law, and do not encompass all obligations under the Withholding Law.

51.1 In this clause 51 the following words have the following meanings:

CGT Asset has the meaning in the *Income Tax Assessment Act 1997*;

Clearance Certificate means a certificate issued under section 14-220 of the Withholding Law that covers the date of Completion;

Relevant Percentage means the percentage amount stated in section 14-200(3)(a) and 14-205(4)(a) of the Withholding Law;

Relevant Price means the higher of:

- the Price (including GST); and
- the market value of the CGT Assets sold under this Contract;

as at the Date of this Contract;

Variation Certificate means a certificate issued under section 14-235 of the Withholding Law that covers the date of Completion;

Withholding Amount means, subject to clauses 51.6 and 51.7, the Relevant Percentage of the first element of the CGT Asset's cost base (for all CGT Assets sold under this Contract) as at the Date of this Contract; and

Withholding Law means Subdivision 14-D of Schedule 1 of the *Taxation Administration Act 1953* and associated provisions.

51.2 If the Relevant Price is less than the dollar amount stated in section 14-215(1)(a) of the Withholding Law as at the Date of this Contract, the parties acknowledge that there are no obligations under the Withholding Law.

51.3 If Clearance Certificates for all the Sellers are provided to the Buyer prior to Completion, the parties acknowledge that there are no obligations under the Withholding Law.

51.4 If neither clauses 51.2 or 51.3 apply, then:

51.4.1 the Seller must provide to the Buyer any information required to enable the Buyer to comply with clause 51.4.2(a), within 5 days of written request from the Buyer;

51.4.2 the Buyer must:

(a) lodge a purchaser payment notification form with the ATO; and

(b) give evidence of compliance with clause 51.4.2(a) to the Seller;

no later than 5 days before the Date for Completion;

51.4.3 the Seller irrevocably instructs the Buyer to draw as part of the Price, and the Buyer must draw and retain on Completion, an unendorsed bank cheque payable to the ATO for the Withholding Amount; and

51.4.4 the parties must both, on the date of Completion, attend the offices of an authorised collection agent of the ATO to deposit the bank cheque referred to in clause 51.4.3 in payment of the Withholding Amount following Completion.

51.5 If clause 51.4 applies and the parties do not comply with clause 51.4.4:

51.5.1 the Buyer indemnifies the Seller for any loss or damage resulting from the Buyer's delay in remitting and/or failure to remit the Withholding Amount to the ATO; and

51.5.2 the Buyer charges the Property (for the benefit of the Seller) with the Buyer's obligations under this clause 51.5.

51.6 Where the Seller gives the Buyer a Variation Certificate prior to Completion, the Withholding Amount is the amount stated in the Variation Certificate.

51.7 Where Clearance Certificates for some but not all of the Sellers are provided to the Buyer prior to Completion, then the Withholding Amount is reduced by the same percentage as the percentage ownership of the Property of the Sellers that are subject to a Clearance Certificate.

51.8 Where a Clearance Certificate is provided by a Seller to the Buyer, the Seller warrants to the Buyer that that Seller is the entity referred to in the Clearance Certificate and is the relevant taxpayer for capital gains tax payable on the sale of the CGT Assets sold under this Contract.

52. Deposit by Instalments

52.1 The following clauses 52.2 to 52.8 inclusive only apply if the 'Deposit by Instalments' option on the Schedule is selected.

52.2 Clauses 2.1, 2.2, 2.3 and 2.4 are deleted.

52.3 The Buyer must pay the Deposit to the Stakeholder. The Seller agrees to accept the payment of the Deposit in two instalments as follows:

52.3.1 5% of the Price by cheque on the Date of this Contract (**First Instalment**); and

52.3.2 the balance of the Deposit (if it has not already been paid) by unendorsed bank cheque on the Date for Completion (**Second Instalment**);

and in every respect time is of the essence for payment of the First Instalment in this clause 52.3.1.

52.4 The Deposit becomes the Seller's property on Completion or on the earlier termination of this Contract by the Seller for the Buyer's default.

52.5 If the First Instalment of the Deposit is:

52.5.1 not paid on time and in accordance with clause 52.3; or

52.5.2 paid by cheque and the cheque is not honoured on first presentation,

the Buyer is in default and the Seller may terminate this Contract immediately by written notice to the Buyer (without the notice otherwise necessary under clause 18) and clause 19 applies. If the Seller does not terminate this Contract in accordance with this clause 52.5, then this Contract remains on foot, subject to this clause 52.5, until either the Seller terminates the Contract pursuant to this clause 52.5, or waives the benefit of this clause 52.5 pursuant to clause 52.8.

52.6 If the Second Instalment of the Deposit is not paid on time in accordance with clause 52.3, then the Seller cannot immediately terminate the Contract for the Buyer's breach of an essential condition. The Seller must make timing of the payment of the Second Instalment an essential condition of the Contract by serving on the Buyer a Default Notice requiring the Buyer to pay the Second Instalment within 14* days after service of the Default Notice (excluding the date of service).

52.7 For clarity, the Buyer must pay the full Price to the Seller, on or before Completion.

52.8 These clauses 52.2 to 52.8 inclusive are for the benefit of the Seller. The Seller may at any time before this Contract is terminated notify the Buyer in writing that the benefit of these clauses 52.2 to 52.8 inclusive is waived.

53. Residential Withholding Tax

Warning: The following clauses 53.1 to 53.9 are subject to the Withholding Law, and do not encompass all obligations under the Withholding Law.

53.1 In this clause 53 the following words have the following meanings:

RW Amount means the amount which the Buyer must pay under section 14-250 of the Withholding Law;

RW Amount Information means the completed RW Amount details referred to on page 3 of this Contract; and

RW Percentage means the percentage amount stated in section 14-250(6), (8) and (9) of the Withholding Law, as applicable to the supply of the Property from the Seller to the Buyer.

53.2 The Seller must provide the Buyer with the RW Amount Information no later than 7 days after the Date of this Contract.

53.3 If the 'Buyer required to make a withholding payment?' option on the Schedule is selected 'no' or if no selection is made, the Seller warrants to the Buyer that the Buyer is not required to make a payment under section 14-250 in relation to the supply of the Property from the Seller to the Buyer.

53.4 The following clauses 53.5 to 53.9 inclusive only apply if the 'Buyer required to make a withholding payment?' option on the Schedule is selected 'yes'.

53.5 Subject to any adjustments to the Price that may arise after the date that the RW Amount Information is provided in accordance with clause 53.2 and which affect the RW Amount, the Seller warrants to the Buyer on the date that the RW Amount Information is provided to the Buyer that the Seller has provided the Buyer with the information required under section 14 255 of the Withholding Law in relation to the supply of the Property from the Seller to the Buyer, and that this information is true and correct to the Seller's knowledge.

53.6 The Buyer must provide the Seller with a copy of the 'GST property settlement withholding notification online form' confirmation email (or emails, if applicable) issued to the Buyer by the ATO no later than:

53.6.1 21 days after a written request from the Seller; or

53.6.2 7 days prior to the Date for Completion, whichever is the earlier.

53.7 The Buyer must provide the Seller with evidence of submission by the Buyer to the ATO of the 'GST property settlement date confirmation online form', with such evidence to be provided prior to or on Completion.

* Alter as necessary

- 53.8 The Seller irrevocably instructs the Buyer to draw as part of the Price, and the Buyer must draw and retain on Completion, an unendorsed bank cheque payable to the ATO for the RW Amount.
- 53.9 In relation to the unendorsed bank cheque required by clause 53.8, the Buyer must:
- 53.9.1 forward the unendorsed bank cheque to the ATO immediately after Completion; and
 - 53.9.2 provide the Seller with evidence of payment of the RW Amount to the ATO.

97 Fitchett Street, Garran ACT 2605
Block 29 Section 8 Garran

SPECIAL CONDITIONS

54 Inconsistency

- 54.1 If there are any inconsistencies between a Special Condition and the Standard Terms, the provisions of the Special Conditions prevail and override the Standard Terms.
- 54.2 Unless otherwise defined, terms in these Special Conditions have the same meaning as they do in the Standard Terms.

55 Definitions

In these Special Conditions, the following words have the meanings described:

- 55.1 **Special Conditions** means these special conditions set out in following pages, being clauses 54 onwards of this Contract.
- 55.2 **Standard Terms** means the printed terms of the 2024 edition of the ACT Law Society Contract for Sale (CS10-2024).

56 Inspection by Buyer

- 56.1 The Buyer has inspected the Property and acknowledges that it was not induced into entering into this Contract by or on behalf of the Seller.
- 56.2 The Buyer accepts the Property in its present condition and in particular:
 - (a) is satisfied as to the nature, quality, condition and state of affairs of the Property and ownership of the Improvements;
 - (b) accepts the Property as it is and subject to all defects (latent or patent); and
 - (c) is satisfied as to the purpose for which the Property may be used and as to all restrictions and prohibitions on its use.
- 56.3 The Buyer may not:
 - (a) make any objection or claim; or
 - (b) delay completion or attempt to rescind or terminate this Contract, because of the condition of the Property as at the date of this Contract.

57 Inability to complete

- 57.1 Without in any way limiting, negating or restricting any rights or remedies which would have been available to either party either at law or in equity had this clause not been included, if either party (and if more than one person comprises the Buyer or Seller then any one of them) prior to Completion:
 - (a) dies or becomes mentally ill, then either party may rescind this Contract by written notice to the other party's solicitor and following which this Contract will be at an end and the provisions of clause 21 will apply
 - (b) being a company, has a summons or application for its winding up presented or has a liquidator, voluntary administrator or controller appointed, or enters into any deed of company arrangement or scheme of arrangement with its creditors, then the party will be in default under this Contract.

58 Agent introduction

- 58.1 The Buyer warrants that introduction was made to the Property by the agent referred to in the Schedule and by no other agent, and notwithstanding completion, indemnifies the Seller against all commission payable to any other agent by reason of the Buyer having been introduced to the Property by such latter agent.
- 58.2 The Seller warrants that the agent referred to in the Schedule is the only agent appointed by the Seller for the purpose of the sale of the Property.

59 Amendments to Standard Terms

59.1 The Standard Terms of the contract are amended as follows:

- (a) clause 2.3 is amended by adding the words "or electronic funds transfer" after "by cheque" and delete the words "or in cash (up to \$3,000)";
- (b) in clause 2.6, the words "or in cash (up to \$200.00)" are deleted;
- (c) clause 8.4 is amended by deleting the words "Buyer's Solicitor" and replacing with "Stakeholder";
- (d) a new clause 10.3 is added as follows:

"The Seller is not required to maintain any lawn or gardens on the Land after the Date of this Contract. The Buyer must not delay Completion, make any objection, requisition or claim for compensation due to any garden or lawn being unkept between the Date of this Contract and Completion."
- (e) clause 13.10 is deleted;
- (f) clause 17.1.1(a) is amended by deleting the words "5% of the Price" and replacing with "\$1,000";
- (g) clause 17.1.2(a) is amended by deleting the words "5% of the Price" and replacing with "\$1,000";
- (h) clause 22.1.2 is amended by deleting the words 'the date 7 days after';
- (i) clause 22.1.3 is amended by inserting 'if the defaulting party is the Buyer' at the beginning, and by deleting the words '7 days after';
- (j) a new clause 26.4 is added as follows:

"by sending via email to the Buyer or the Buyer's Solicitor. The email is considered to have been received at the time it was sent by the sending party. If an email is sent after 5:00pm, or if the email is sent on a day that is not a Business Day, the email is taken to have been received at 9:00am on the next Business Day."; and
- (k) clause 51.2 is deleted in its entirety and replaced with the words 'Not used'.

60 Electronic execution

- 60.1 The Parties acknowledge and agree that this Contract may be executed using:
- (a) DocuSign;
 - (b) Original wet signature; or
 - (c) An electronically scanned and transmitted version of an original signature.
- 60.2 Execution of this contract per this Special Condition shall be considered as an original signature for all purposes and shall have the same force and effect as an original signature.
- 60.3 Where execution occurs per special condition 58.1(a), a "Certificate Of Completion" or similar document issued by DocuSign must also be provided.
- 60.4 The Parties must not raise any objection, requisition, claim for compensation or damages, delay Completion or rescind or terminate this Contract in respect of any matter under this Special Condition.

61 Adjustments

- 61.1 If Completion does not occur on or before the Date for Completion due to the fault of the Buyer, the Buyer acknowledges that all Land Charges in accordance with Clause 8.1 of the Standard Terms will be adjusted from the Date for Completion.
- 61.2 The Buyer acknowledges that notwithstanding clause 59.1, the Seller will remain entitled to the Income up to the date of actual Completion.

62 Keys

- 62.1 The Seller will supply all keys in its possession to access the improvements on the Land on Completion. The Buyer must not delay Completion, make any objection, requisition or claim for compensation in relation to the availability of keys to the improvements.

63 FIRB Approval

- 63.1 The Buyer warrants to the Seller that if it is a "foreign corporation" or a "foreign person" as defined in the *Foreign Acquisition & Takeovers Act 1975* (Cth), it has obtained the consent of the Foreign Investment Review Board, in accordance with the provisions of the *Foreign Acquisition & Takeovers Act 1975* (Cth), to its purchase of the Property. The Buyer hereby indemnifies and releases the Seller against all liability, loss, damage and expenses that the Seller may suffer or incur as a direct or indirect consequence of a breach of this warranty.

64 Buyers' caveat

- 64.1 If, prior to Completion, the Buyer registers a caveat or other equitable interest against the Land and, as a result of the existence of that interest, completion cannot occur using electronic means, then the Buyer agrees to pay to the Seller as an adjustment at settlement any additional costs (including legal costs of \$330 including GST), fees or charges borne by the Seller as a result.

65 Guarantee of Buyer

- 65.1 Where the Buyer is a corporation, other than a listed public company, on entering into this Contract the Buyer acknowledges and agrees that, in accordance with its constitution and the law applicable to it, each of the directors of the Buyer have, on the date of this Contract, properly executed and delivered to the Seller the Director's Guarantee annexed to this Contract.
- 65.2 The Guarantee must be given by the Guarantors in the form of the Guarantee annexed to this Contract.
- 65.3 The Guarantee annexed to this Contract must be signed by the Guarantor and the Buyer in order to effect exchange of this Contract.
- 65.4 If the Guarantee annexed to this Contract is not executed and delivered as required by this clause, the Buyer will be in breach of a fundamental and essential condition of this Contract and the Seller will be entitled to enforce all remedies available under this Contract and at law for such breach.

ANNEXURE 'A'

Director's Guarantee

I, (Name of Director)

of (Address) _____

agree as follows:

- 1 I am a Director of the Buyer.
- 2 In consideration of the Seller entering into this Contract at my request, I agree to guarantee to the Seller:
 - a. the performance and observance by the Buyer of all its obligations under this Contract, before, on and after Completion; and
 - b. the payment of all money payable to the Seller or to third parties under this Contract or otherwise.
- 3 This is a continuing guarantee and binds me notwithstanding:
 - a. my subsequent death, bankruptcy or liquidation or the subsequent death, bankruptcy or liquidation of any one or more of the Buyer or the Buyer's Director/s;
 - b. any indulgence, waiver or extension of time by the Seller to the Buyer or to me or the Buyer's Director/s; and
 - c. Completion.
- 4 In the event of any breach by the Buyer covered by this guarantee, including in the payment of any money payable to the Seller or to third parties under this Contract or otherwise, the Seller may proceed to recover the amount claimed as a debt or as damages from me without having instituted legal proceedings against the Buyer or any other of the Buyer's Director/s and without first exhausting the Seller's remedies against the Buyer.
- 5 I agree to keep the Seller indemnified against any liability, loss, damage or claim due to the default of the Buyer, which the Seller may incur in respect of this Contract.

Dated:

SIGNED SEALED AND DELIVERED

by the Buyer's Director(s) in the presence of:

Witness

Signature of Buyer's Director(s)

Name of Witness

**AUSTRALIAN CAPITAL TERRITORY
TITLE SEARCH**

LAND

Garran Section 8 Block 29 on Deposited Plan 1662

Lease commenced on 21/06/1966, granted on 17/11/1966, terminating on 20/06/2065

Area is 911 square metres or thereabouts

Proprietor

MICHAEL DAVID HUTCHISON

97 FITCHETT ST, GARRAN ACT 2605

HEIDI INGRID HUTCHISON

97 FITCHETT ST, GARRAN ACT 2605

as Joint Tenants

REGISTERED ENCUMBRANCES AND INTERESTS

Original title is **Volume 191 Folio 57**

Restrictions

Purpose Clause: Refer Crown Lease

S.180 Land Act 1991: Compliance/Completion Cert Issued

S.28B City Area Leases Act 1936: Repealed - Land Act 1991

Registered Date	Dealing Number	Description
11/10/2023	3272147	Mortgage to QUDOS MUTUAL LTD (ACN: 087 650 557)

End of interests

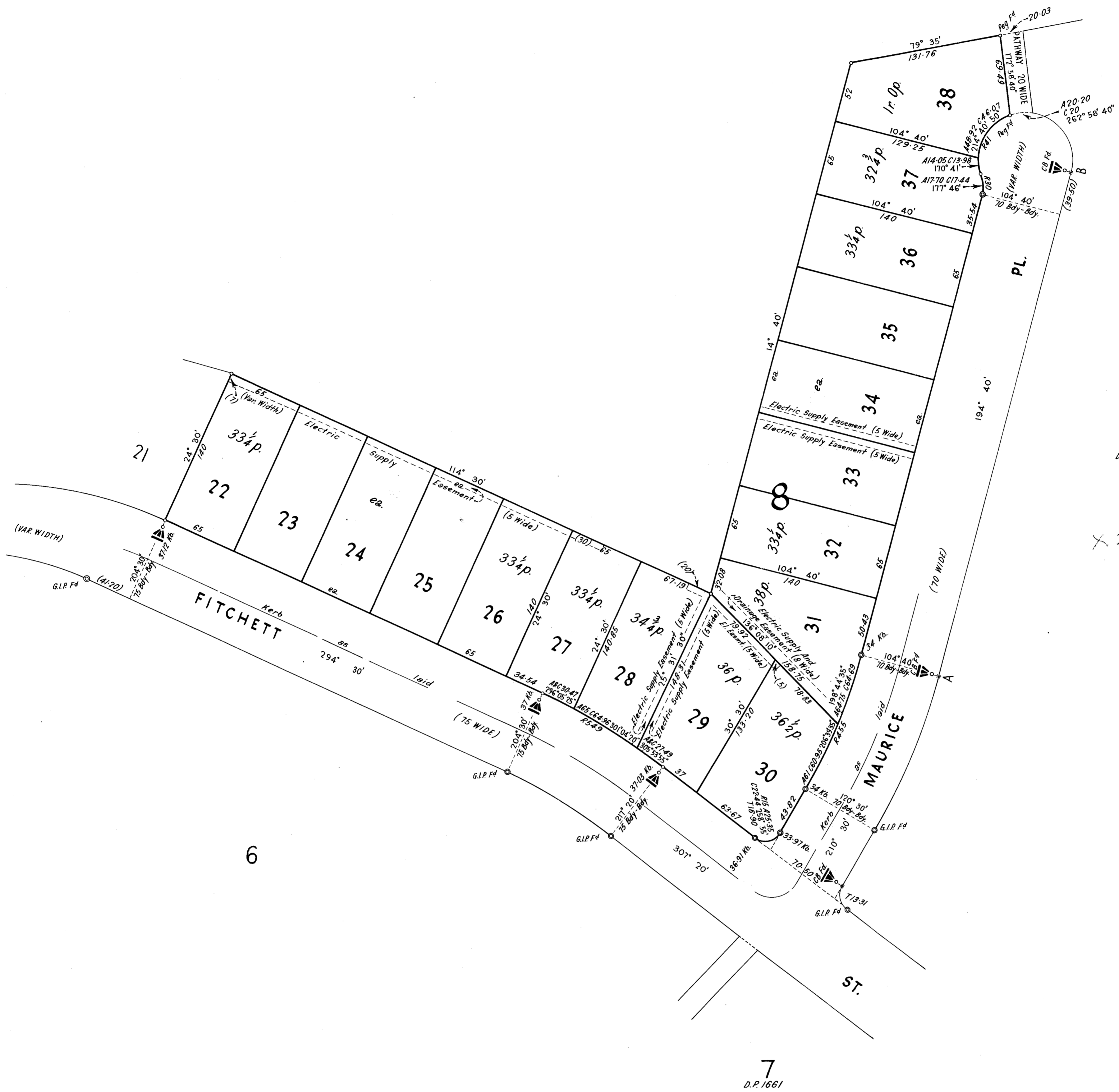

Azimuth: A-B (Strom)

REFERENCE & PERMANENT MARKS

- ⊙ Denotes G.I.P. in road 6 radially from T.P.
- ⊙ " C.B. " " 6 " " T.P.

I, VINCENT GODFREY LLOYD, of Canberra, a surveyor specially licensed by the Commonwealth under the provisions of the Real Property Ordinance 1925-1961 do hereby solemnly and sincerely declare (a) that all boundaries and measurements shown on this plan are correct, (b) that all survey marks found and relevant physical objects on or adjacent to the boundaries are correctly represented, (c) that all physical objects indicated exist in the positions shown, (d) that the whole of the material facts in relation to the land are correctly represented, (e) that the survey has been made (1) by me, (2) under my supervision and completed on the 16th day of March, 1966 and the reference marks have been placed as shown hereon.

And I make this solemn declaration by virtue of the Statutory Declarations Act 1959 conscientiously believing the statements contained therein to be true in every particular.

Declared at Canberra the 13th day of July 1966
A.J. Barrett-Eggs
 Commissioner for Declarations under the Statutory Declarations Act 1959.

I certify that this plan is the plan prepared in accordance with sub-section 6 of section 6 of the Districts Ordinance 1925-1966.
V. Lloyd
 Licensed Surveyor.
 Commonwealth Surveyor-General.

PLAN OF
 BLOCKS 22-38 SECTION 8

DIVISION: GARRAN
 DISTRICT: CANBERRA CITY
 AUSTRALIAN CAPITAL TERRITORY.

Scale: 60 feet to an inch.
 Field Books: K 3363

Deposited in the office of the Registrar of Titles at Canberra in the Australian Capital Territory the seventeenth day of August 1966 at 15 minutes past two o'clock in the after noon.
 Approved

[Signature]
 Registrar of Titles.

DEPOSITED PLAN.
 1662

1662

X 293

ORIGINAL

CANCELLED AND COMPUTER
CERTIFICATE OF TITLE ISSUED

Reference to last Title
Vol. 191 Folio 57

Register Book
Vol. 765 Folio 76

Issued on Discharge No. 313116

Lease commenced on 21/6/1966 AUSTRALIAN CAPITAL TERRITORY

Section 28B City Area
Leases Ordinance 1936
applies

Real Property Ordinance 1925

EVIDENCE PRODUCED THAT
CERTIFICATE UNDER SEC 179(1)
LAND ACT 1991 ISSUED

Certificate of Title

LEASEHOLD

ANDREW IAN KENNER of 97 Fitchett Street Garran Electrician and HEATHER LYNETTE KENNER
his wife as joint tenants

is now seised of an estate of leasehold for a term of ninety nine years commencing on the
twenty first day of June one thousand nine hundred and
sixty six subject, nevertheless to the covenants reservations and conditions contained in
Crown Lease registered Vol. 191 Fol. 57 and subject also to such encumbrances, liens, and interests
as are notified by memorial underwritten or endorsed hereon, in that piece of land situated in the Australian Capital
Territory being the piece of land shown by pink colour on the plan endorsed hereon which said piece of land is
Block 29 Section 8 of Garran as delineated on Deposited Plan number 1662
deposited in the office of the Registrar of Titles in the said Territory.

IN WITNESS WHEREOF I have hereunto signed my name and affixed my seal this twelfth day
of September one thousand nine hundred and seventy nine

Signed in the presence of
J. N. [Signature]



Registrar of Titles

Memorial of Encumbrances, Liens, and

Interests, above referred to

- No. 85186 Mortgage to Commissioner for Housing
- No. 181892 Mortgage to Commonwealth Trading Bank
of Australia
- No. 233609 Mortgage to Commonwealth Trading Bank
of Australia

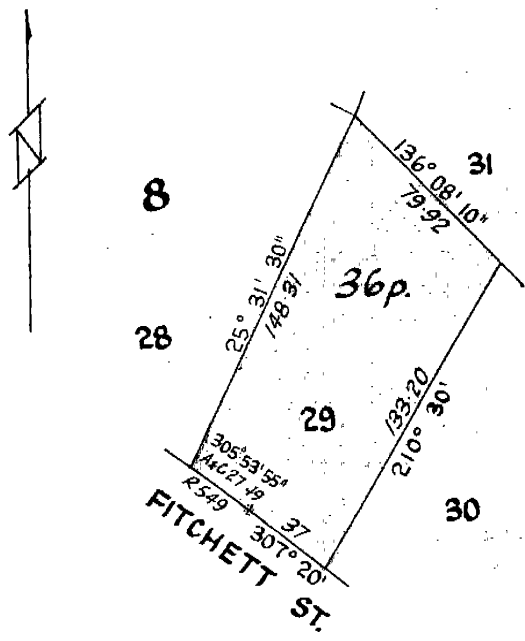

-Scale:- 60 Feet to an inch-

No. 313116 DISCHARGE OF MORTGAGE No. 85186

Entered 12th September 1979 at ten o'clock in the fore noon



[Signature]
Registrar of Titles

No. 315952 DISCHARGE OF MORTGAGE No. 181892

Entered 19th September 1979 at four o'clock in the after noon



[Signature]
Registrar of Titles

No. 315953 DISCHARGE OF MORTGAGE No. 233609

Entered 19th September 1979 at four o'clock in the after noon



[Signature]
Registrar of Titles

No. 318751 MORTGAGE TO COMMONWEALTH TRADING BANK OF AUSTRALIA

Entered 29th October 1979 at four o'clock in the after noon



[Signature]
Registrar of Titles

No. 785007 MORTGAGE TO COMMONWEALTH SAVINGS BANK OF AUSTRALIA

Entered 20 MAY 1992 at TEN o'clock in the FORE noon



[Signature]
Registrar of Titles
B. J. McCARTHY DEPUTY

No. 792739 DISCHARGE OF MORTGAGE No. 785007

Entered 9 JUL 1992 at Ten o'clock in the fore noon



[Signature]
Registrar of Titles
B. J. McCARTHY DEPUTY

CANCELLED AND COMPUTER
CERTIFICATE OF TITLE ISSUED



LEASE CONVEYANCING ENQUIRY

Your response is sought to the following questions in relation to:

LAND: Please provide details of the land you are enquiring about.

Unit	0	Block	29	Section	8	Suburb	GARRAN
-------------	----------	--------------	-----------	----------------	----------	---------------	---------------

Leased by the Australian Capital Territory on behalf of the Commonwealth under the Land (Planning and Environment) Act 1991, Planning & Development Act 2007 and Planning Act 2023.

- | | No | Yes |
|--|-----------|------------------|
| 1. Have any notices been issued relating to the Crown Lease? | (X) | () |
| 2. Is the Lessor aware of any notice of a breach of the Crown Lease? | (X) | () |
| 3. Has a Certificate of Compliance been issued? (N/A ex-Government House) <input type="checkbox"/> | () | (X) |
| Certificate Number: 7598 | | Dated: 07-MAY-76 |
| 4. Has an application for Subdivision been received under the Unit Titles Act? | | (see report) |
| 5. Has the Property been nominated for provisional registration, provisionally registered or registered in accordance with provisions of the Heritage Act 2004? | | (see report) |
| 6. If an application has been determined, is the land subject to an Environmental Impact Statement under Chapter 8 of the Planning & Development Act 2007, or part 6.3 of the Planning Act 2023? | | (see report) |
| 7. Has a development application been received, or approval (applications lodged prior to 2 April 1992 will not be included)? | | (see report) |
| 8. Has an application been received or approved for Dual Occupancy? (applications lodged prior to 2 April 1992 will not be included) | | (see report) |
| 9. Has an Order been made in respect of the Land pursuant to Part 11.3 of the Planning & Development Act 2007 or Part 12.3 of the Planning Act 2023? | | (see report) |
| 10 Contaminated Land Search - Is there information recorded by Environment ACT regarding the contamination status of the land? | | (see report) |

Applicant's Name : InfoTrack, InfoTrack
 E-mail Address : actenquiries@infotrack.com.au
 Client Reference : 82681 - 194104480

Date: 11-MAY-26 14:53:53



STATUTORY PLANNING
DEVELOPMENT SOLUTIONS BRANCH
480 Northbourne Avenue
DICKSON ACT 2601

11-MAY-2026 14:53

PLANNING AND LEASE MANAGER (PaLM)
LEASE CONVEYANCING ENQUIRY REPORT

Page 1 of 2

INFORMATION ABOUT THE PROPERTY

GARRAN Section 8/Block 29

Area(m2): 910.4
Unimproved Value: \$1,160,000 **Year:** 2025
Subdivision Status: Application not received under the Unit Titles Act.

Heritage Status: Nil.

Environment Assessment: The Land is not subject to an Environmental Impact Statement under Chapter 8 of the Planning & Development ACT 2007, or part 6.3a of the Planning Act 2023.

DEVELOPMENT APPLICATIONS ON THE PROPERTY (SINCE APRIL 1992)

No Applications Found.

DEVELOPMENT APPLICATIONS ON THE ADJACENT PROPERTIES (LAST 2 YEARS ONLY)

The information on development applications on adjacent blocks is to assist purchasers to be aware of possible nearby development activity. Please note however, it doesn't cover all development activity. Exempt activities can include but are not limited to, new residences, additions to residences, certain sheds, carports and pergolas etc. Information on exempt developments can be found at <https://www.planning.act.gov.au/applications-and-assessments/development-applications/check-if-you-need-a-da>

LAND USE POLICIES

To check the current land use policy in the suburb that you are buying a property in, please check the Territory Plan online at <https://www.legislation.act.gov.au/ni/2023-540/>

CONTAMINATED LAND SEARCH

Information is not recorded by the Environment Protection Authority regarding the contamination status of this land. However, this does not absolutely rule out the possibility of contamination and should not be interpreted as a warranty that there is no contamination. To be completely sure, independent tests should be arranged.

ASBESTOS SEARCH

ACT Government records indicate that asbestos (loose fill or otherwise) is not present on this land. However, the accuracy of this information is not guaranteed. If the property was built prior to 1 January 2004, you should make your own enquiries and obtain reports (from a licensed Asbestos Assessor) in relation to the presence of loose-fill asbestos insulation (and other forms of asbestos e.g. bonded asbestos) on the premises.



STATUTORY PLANNING
DEVELOPMENT SOLUTIONS BRANCH
480 Northbourne Avenue
DICKSON ACT 2601

11-MAY-2026 14:53

PLANNING AND LEASE MANAGER (PaLM)
LEASE CONVEYANCING ENQUIRY REPORT

Page 2 of 2

CAT CONTAINMENT AREAS

Cat containment has been extended across the ACT for cats born on or after 1 July 2022. Containment means keeping your cat on your premise 24 hours a day. This can include your house or apartment, enclosed area in a backyard or courtyard, a cat crate or leash. Cats born before 1 July 2022 do not have to be contained unless they live in one of the 17 currently declared cat containment suburbs. All cats (regardless of age) located in the following suburbs must be contained to their premise 24 hours a day. However, cats can be walked on a leash and harness under effective control in all containment suburbs: BONNER, COOMBS, CRACE, DENMAN PROSPECT, FORDE, JACKA, LAWSON, MOLONGLO, MONCRIEFF, STRATHNAIRN, THE FAIR in north WATSON, THROSBY, WRIGHT, GUNGAHLIN TOWN CENTRE, MACNAMARA, TAYLOR and WHITLAM. More information on cat containment is available at <https://www.cityservices.act.gov.au/pets-and-wildlife/domestic-animals/cats/cat-containment> or by phoning Access Canberra on 13 22 81.

URBAN FOREST ACT 2023

The Urban Forest Act 2023 (or Tree Protection Act 2005 where applicable) protects individual trees of importance and urban forest areas that require particular protection. A Tree Register has been established and can be found on the Transport Canberra and City Services website https://www.cityservices.act.gov.au/trees-and-nature/trees/act_tree_register or for further information please call Access Canberra on 132281.

----- END OF REPORT -----

Report

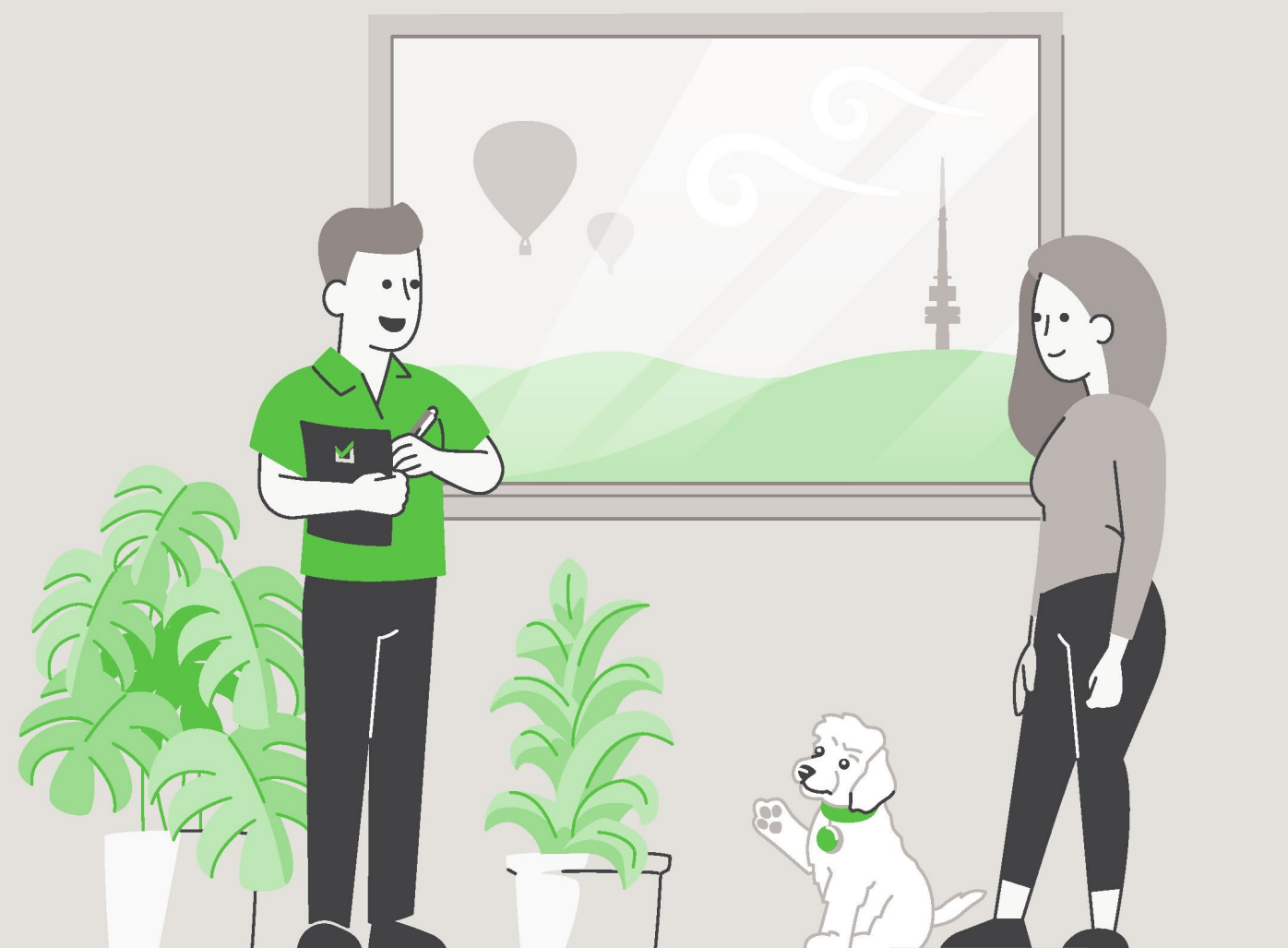

LIMITED LIABILITY TO A PURCHASER WITHIN THE AUSTRALIAN CAPITAL TERRITORY

This Report is made solely for the use and benefit of the Client. The Consultant is not liable for any reliance placed on this report by any third party. However, within the ACT only and in accordance with the Civil Law (Sale of Residential Property) Act 2003 and the Civil Law (Sale of Residential Property) Regulations 2004, a copy of the report must be attached to the Contract for Sale and may in certain circumstances be relied upon by the Purchaser of residential property.

The circumstances in which a Purchaser of residential property within the ACT may rely on this report in respect of the state of the property at the time of the inspection are as follows:

- (a)** The inspection was carried out no earlier than three months before the day the property was first advertised or offered for sale or listed by an agent; and
- (b)** The date on which the contract was entered into was not more than 180 days after the date of the inspection.
- (c)** The report is provided to the Purchaser prior to or at the time the Contract for Sale is entered into between the Purchaser and vendor.
- (d)** The service requested is the Standard Inspection Report.

Building Report

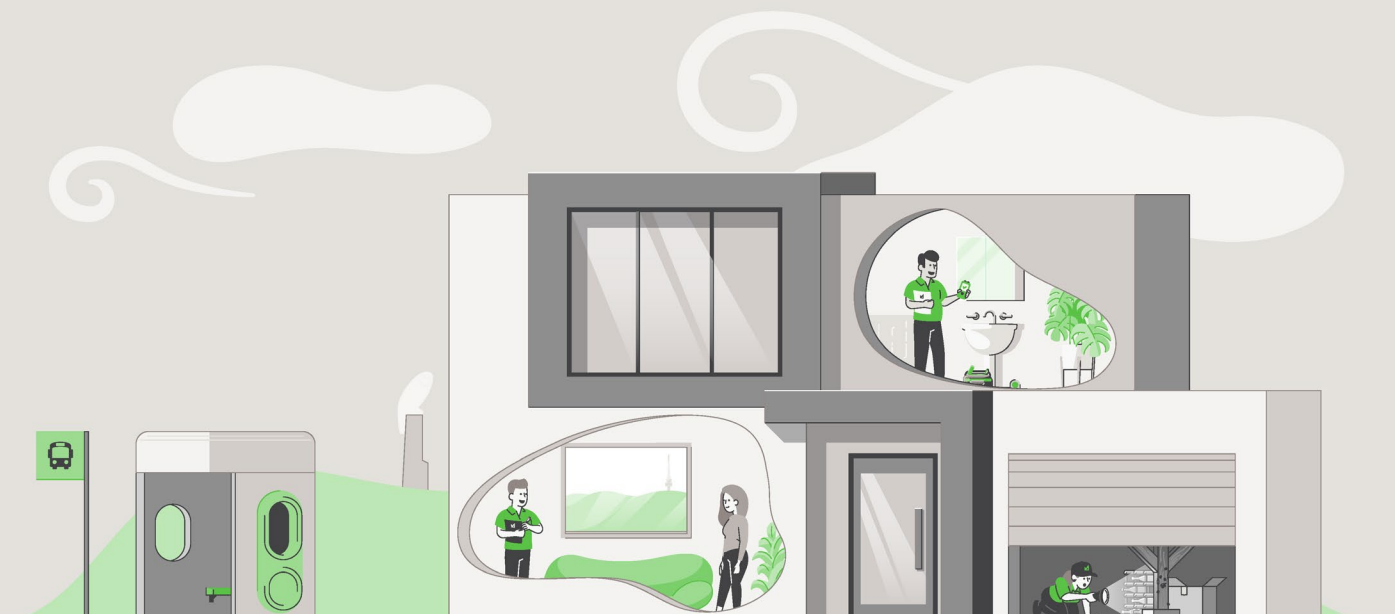

CONCLUSION AND SUMMARY

The purpose of the Inspection is to identify the major defects and safety hazards associated with the property at the time of the Inspection. The Inspection and reporting are limited to a visual assessment of the Building Members in accord with Appendix C AS4349.1-2007.

The overall condition of this building has been compared to similar constructed buildings of approximately the same age where those buildings have had a maintenance program implemented to ensure that the building members are still fit for purpose.

The incidence of Major Defects in this Residential Building as compared with similar Buildings is considered: **Low**

The incidence of Minor Defects in this Residential Building as compared with similar Buildings is considered: **Low**

The overall condition of this Residential Dwelling in the context of its age, type and general expectations of similar properties is: **Above Average**

Please Note: This is a general appraisal only and cannot be relied upon on its own – read the Report in its entirety.

This Summary is supplied to allow a quick and superficial overview of the Inspection results. This Summary is NOT the Report and cannot be relied upon on its own. This Summary must be read in conjunction with the full Report and not in isolation from the Report. If there should happen to be any discrepancy between anything in the Report and anything in this Summary, the information in the Report shall override that in this Summary.

PROPERTY STATISTICS

Building Report	Above Average
Compliance Report	Please read full compliance report section of the report
Pest Inspection	No active subterranean termites (live specimen) were found
Energy Efficiency Rating	1.5 Stars
Inspection Date	Thursday, May 7 th 2026
Name of Assessor	Ned Strickland
Reference Number	68121
Address of Property Inspected	97 Fitchett Street, Garran ACT 2605
Client	Hutchinson
Block and Section	Block 29 Section 8 GARRAN
Year original residence COU was issued	1972
Block size (approximately)	910m ²
House size (approximately)	Upper Level: 194.45m ² Lower Level: 67.00m ² Garage: 55.00m ² Total: 316.45m ²
Weather conditions at time of Inspection	Fine
Occupancy Status	Unoccupied (furnished/styled)

*The table above is to be used as a quick reference. Please read the full Report before reaching your conclusion regarding the condition of the Property.

Whilst every care has been taken to ensure the accuracy of the property house and block size, we accept no responsibility for any inaccuracies as supplying this information exceeds a standard building inspection under AS4349.1-2007.

PROPERTY CONSTRUCTION DETAILS

Flooring	Concrete and timber flooring
External walls	Double brick
Roof framing	Timber: Conventionally pitched roof framing
Roof cladding	Concrete roof tiles
Glazing	Single glazed windows
Cooktop	Electric cooktop
Oven	Electric oven
Dishwasher	Bosch

*Whilst every care has been taken to ensure the accuracy of the property construction details, we accept no responsibility for any inaccuracies of construction details or testing of appliances.

GENERAL ACCESS LIMITATIONS

Internal	At the time of inspection, the building was furnished. This allows for a limited inspection in areas not restricted by furnishings, stored goods, floor mats, etc.
External	No inspection was made to sections of the residence and/or structures built on the side boundary
Roof void	NOTE. Inspection around the eaves was restricted due to low pitch and clearance to allow bodily access in this area. This allows only for a limited visual inspection from a distance to be carried out. Other restrictions found in the roof void: Insulation on top of ceiling restricting visual inspection of the ceiling framing
Subfloor	The visual inspection of the subfloor framing was restricted in areas due to stored items restricting access and underfloor insulation installed.
On-top of roof	The inspection was restricted to visually looking from a 3.6m ladder lent against the gutter in several areas around the building
Garage	The inspection of the garage was restricted due to stored goods being kept in the area at the time of inspection

*Where access is noted as limited or restricted, it is recommended that access be gained to these areas as these areas may contain concealed defects.

DEFINITIONS

Good	The item is in the Inspector's opinion of an acceptable standard with no defects visible. Superficial defects will not be commented on
Fair	The item in the Inspector's opinion has some minor defects and requires minimal maintenance or repair
Poor	The item in the Inspector's opinion needs significant repair or replacement

ENTRANCE

Ceiling	Good
Walls	Minor cracking was noted above the door. This is caused through normal building movement and is not considered to be excessive cracking
Door and door hardware	Good
Floor coverings	Good

LOUNGE ROOM

Ceiling	Good
Walls	Good
Door and door hardware	Good
Floor coverings	Good

FAMILY ROOM

Ceiling	Good
Walls	Good
Door and door hardware	Good
Floor coverings	Good

KITCHEN/DINING ROOM

Ceiling	Good
Walls	Good
Floor coverings	Good
Kitchen cupboards	Fair/serviceable condition
Bench top	Fair/serviceable condition. There are some marks and signs of general wear
Splashback	The silicone joint between the bench top and the bottom of the splashback requires re-application. This is part of normal ongoing maintenance
Exhaust fan	The exhaust fan was operational at the time of inspection

HALLWAY

Ceiling	Good
Walls	Good
Door and door hardware	Good
Floor coverings	Good
Linen cupboard	Good

SEWING ROOM

Ceiling	Good
Walls	Good
Door and door hardware	Good
Floor coverings	Good

RUMPUS ROOM

Ceiling	Good
Walls	Good
Door and door hardware	Good
Floor coverings	Good

BEDROOM 1

Ceiling	Good
Walls	Good
Door and door hardware	Good
Floor coverings	Good
Wardrobe	Good

BEDROOM 2

Ceiling	Good
Walls	Good
Door and door hardware	Good
Floor coverings	Good
Wardrobe	Good

BEDROOM 3

Ceiling	Good
Walls	Good
Door and door hardware	Good
Floor coverings	Good
Wardrobe	Good

ENSUITE

Ceiling	Good
Walls	Good
Door and door hardware	Good
Floor coverings	Good
Shower screen	Good
Water leakage in shower area?	There was no water leakage detected
Floor and wall tiles in shower area	Good
Vanity/Basin	Good
Taps	Good
Toilet suite	Good
Exhaust fan	The exhaust fan was operational at the time of inspection

BATHROOM

Ceiling	Good
Walls	Good
Door and door hardware	Good
Floor coverings	Good
Shower screen	Good
Water leakage in shower area?	There was no water leakage detected
Floor and wall tiles in shower area	Good
Vanity/Basin	Good
Taps	Good
Bath	Good
Exhaust fan	The exhaust fan was operational at the time of inspection

TOILET

Ceiling	Good
Walls	Good
Door and door hardware	Good
Floor coverings	Good
Toilet suite	Good
Exhaust fan	The exhaust fan was operational at the time of inspection

LAUNDRY

Ceiling	Good
Walls	Good
Door and door hardware	Good
Floor coverings	Several loose/drummy skirting tiles noted. Recommend repairs by a qualified tradesperson.
Laundry tub	Good
Splashback	Good
Exhaust fan	An exhaust fan is not installed; however, ventilation is provided to the room by opening the window

ROOF CAVITY

Construction	Good
--------------	------

SUBFLOOR

Subfloor soil conditions	The subfloor soil was generally dry at the time of inspection
Ventilation	Restricted due to the construction type of the house (brick cavity), with internal brick walls in the subfloor region minimising cross ventilation
Floor structure	Good
Access door to subfloor area	Good

EXTERIOR

Driveway and paths	Good. No major cracking noted
Roof covering	Good
Roof pointing	Good
Roof flashings	Good
Eaves	Good
Fascia	Good
Gutters	Good. The gutters appear to be in functional condition
External walls	Good. No major cracking noted
Windows	Good
Fences	Good
Gate	Good
Front Terrace	The handrails have been constructed lower than 1m in height. Although the handrails were compliant at the time of the initial construction, consideration should be given to raising the handrail height to 1m or above to eliminate the fall potential
Pergola	Good
Rear timber shed	The roof covering drains towards the neighbouring property and appears to be encroaching the boundary. Recommend rectification works
Retaining walls	Some minor cracking was found in the retaining walls. The walls are still retaining the ground behind the wall adequately. Apart from monitoring, no action is required. Recommend installing an approved handrail to the front stone retaining wall to prevent a fall in areas where the fall potential is greater than 1m in height

EXTERIOR – CONTINUED

Pool/Spa safety	As the location of the pool fence does not match the approved plans, recommend certifier assessment and approval to ensure there are no potential safety hazards
Site drainage	The site generally drains away from the perimeter of the building

EXTERNAL CHANGE ROOM

Structure	Good
Ceiling	Good
Walls	Various areas of minor cracking noted in the external walls. The cracking found was not of major structural significance
Door and door hardware	Good
Floor coverings	Good
Shower screen	Good
Floor and wall tiles in the shower area	Good
Vanity/basin	Good
Taps	Good

GARAGE

Slab	Good. No major cracking noted
Ceiling	Good
Walls	Various areas of minor cracking noted in the external walls. The cracking found was not of major structural significance
Garage door	Good
Is an auto opener installed on the roller door?	Yes
Access door	Good

DEFINITIONS

Above Average: The overall condition is above that consistent with dwellings of approximately the same age and construction. Most items and areas are well maintained and show a reasonable standard of workmanship when compared with buildings of similar age and construction.

Average: The overall condition is consistent with dwellings of approximately the same age and construction. There will be areas or items requiring some repair or maintenance.

Below Average: The Building and its parts show some significant defects and/or very poor non-tradesman like workmanship and/or long-term neglect and/or defects requiring major repairs or reconstruction of major building elements.

Client: The person or persons, for whom the Inspection Report was carried out or their Principal (i.e., the person or persons for whom the report is being obtained).

Building Consultant: A person, business or company who is qualified and experienced to undertake a pre-purchase inspection in accordance with Australian Standard AS 4349.1-2007 'Inspection of Buildings. Part 1: Pre-Purchase Inspections – Residential Buildings'. The consultant must also meet any Government licensing requirement, where applicable.

Building & Site: The inspection of the nominated residence together with relevant features including any car accommodation, detached laundry, ablution facilities and garden sheds, retaining walls more than 700 mm high, paths and driveways, steps, fencing, earth, embankments, surface water drainage and storm water run-off within 30 m of the building, but within the property boundaries. In the case of strata and company title properties, the inspection is limited to the interior and immediate exterior of the nominated residence and does not include inspection of common property.

Readily Accessible Areas: Areas which can be easily and safely inspected without injury to person or property, are up to 3.6 metres above ground or floor levels or accessible from a 3.6 metre ladder, in roof spaces where the minimum area of accessibility is not less than 600 mm high by 600 mm wide and subfloor spaces where the minimum area of accessibility is not less than 400 mm high by 600 mm wide, providing the spaces or areas permit entry. Or where these clearances are not available, areas within the consultant's unobstructed line of sight and within arm's length.

Structure: The loadbearing part of the building, comprising the Primary Elements.

Primary Elements: Those parts of the building providing the basic loadbearing capacity to the Structure, such as foundations, footings, floor framing, loadbearing walls, beams, or columns. The term 'Primary Elements' also includes other structural building elements including those that provide a level of personal protection such as handrails; floor-to-floor access such as stairways; and the structural flooring of the building such as floorboards.

Secondary Elements: Those parts of the building not providing loadbearing capacity to the Structure, or those non-essential elements which, in the main, perform a completion role around openings in Primary Elements and the building in general such as non-loadbearing walls, partitions, wall linings, ceilings, chimneys, flashings, windows, glazing or doors.

Finishing Elements: The fixtures, fittings and finishes applied or affixed to Primary Elements and Secondary Elements such as baths, water closets, vanity basins, kitchen cupboards, door furniture, window hardware, render, floor, and wall tiles, trim or paint. The term 'Finishing Elements' does not include furniture or soft floor coverings such as carpet and lino.

Major Defect: A defect of significant magnitude where rectification has to be carried out in order to avoid unsafe conditions, loss of utility or further deterioration of the property.

Minor Defect: A defect other than a Major Defect.

Safety Hazard: Any item that may constitute an immediate or imminent risk to life, health, or property. Occupational, health and safety or any other consequence of these hazards has not been assessed.

Tests: Where appropriate the carrying out of tests using the following procedures and instruments:

Dampness Tests means additional attention to the visual examination was given to those accessible areas which the consultant's experience has shown to be particularly susceptible to damp problems. Instrument testing using electronic moisture detecting meter of those areas and other visible accessible elements of construction showing evidence of dampness was performed.

Physical Tests means the following physical actions undertaken by the consultant: opening and shutting of doors, windows and draws; operation of taps; water testing of shower recesses; and the tapping of tiles and wall plaster.

IMPORTANT ADVICE

NB. In the case of strata and company title properties, the Inspection is limited to the interior and immediate exterior of the particular unit being inspected. The exterior above ground floor level is not inspected. The complete Inspection of other common property areas would be the subject of a Special-Purpose Inspection Report which is adequately specified.

Trees: Where trees are too close to the house this could affect the performance of the footing as the moisture levels change in the ground. A Geotechnical Inspection can determine the foundation material and provide advice on the best course of action with regards to the trees.

The Septic Tanks: Should be inspected by a licensed plumber.

Swimming Pools: Swimming Pools/Spas are not part of the Standard Building Report under AS4349.1-2007 and are not covered by this Report. We strongly recommend a pool expert should be consulted to examine the pool and the pool equipment and plumbing, as well as the requirements to meet the standard for pool fencing. Failure to conduct this Inspection and put into place the necessary recommendations could result in finds for non-compliance under the legislation.

Surface Water Drainage: The retention of water from surface run off could have an effect on the foundation material which in turn could affect the footings to the house. Best practice is to monitor the flow of surface water during rainfall and stormwater runoff and have the water directed away from the house or to storm water pipes by a licensed plumber/drainier.

Weep Holes: External brick (and stone) walls are a porous material that behave much like a sponge. During a rain event, the masonry wall absorbs water and actually stores it. The weep holes are designed for two purposes. 1. To provide an opening to allow water to drain out through the bottom of the wall. 2. To allow ventilating air to enter behind the wall to help dry the structure. If weep holes have been noted as being not installed, it is recommended to consult a builder on how to best rectify the problem.

Water Leaks from Roof: The inspector cannot, and does not, offer an opinion on whether the roof currently leaks or may be subject to future leaks. The only way to determine whether a roof is absolutely watertight is to make observations during prolonged rainfall.

Subfloor dampness: The presence of dampness is not always consistent as the prevailing and recent weather conditions at the time an inspection is carried out may affect the detection of damp problems. The absence of any dampness at the time of inspection does not necessarily mean the building will not experience some damp problems in other weather conditions. Likewise, whether or not services have been used for some time prior to an inspection being carried out will affect the detection of dampness.

Shower: Where a shower recess has been water tested, and no leakage was evident, this does not necessarily mean that the shower will not leak after prolonged use. Accordingly, to fully detect and assess a damp problem may require the monitoring of the building over a period of time.

SCOPE AND LIMITATIONS

Any person who relies upon the contents of this Report does so acknowledging that the following clauses, which define the Scope and Limitations of the Inspection, form an integral part of the Report.

1) This Report is not an all-encompassing Report dealing with the building from every aspect. It is a reasonable attempt to identify any obvious or significant defects apparent at the time of the Inspection. Whether or not a defect is considered significant or not, depends to a large extent upon the age and type of the building inspected. This Report is not a Certificate of Compliance with the requirements of any Act, Regulation, Ordinance or By-law. It is not a structural Report. Should you require any advice of a structural nature you should contact a structural engineer.

2) This is a visual Inspection only, limited to those areas and sections of the property fully accessible and visible to the Inspector on the date of Inspection. The Inspection DID NOT include breaking apart, dismantling, removing, or moving objects including, but not limited to, foliage, mouldings, roof insulation/sisalation, floor or wall coverings, sidings, ceilings, floors, furnishings, appliances, or personal possessions. The inspector CANNOT see inside walls, between floors, inside skillion roofing, behind stored goods in cupboards and other areas that are concealed or obstructed. The inspector DID NOT dig, gouge, force or perform any other invasive procedures. Visible timbers CANNOT be destructively probed or hit without the written permission of the property owner.

3) This Report does not and cannot make comment upon: Defects that may have been concealed; the assessment or detection of defects (including rising damp and leaks) which may be subject to the prevailing weather conditions; whether or not services have been used for some time prior to the Inspection and whether this will affect the detection of leaks or other defects (e.g. In the case of shower enclosures the absence of any dampness at the time of the inspection does not necessarily mean that the enclosure will not leak); the presence or absence of timber pests; gas-fittings; common property areas; environmental concerns; the proximity of the property to flight paths, railways, or busy traffic; noise levels; health and safety issues; heritage concerns; security concerns; fire protection; site drainage (apart from **surface** water drainage); swimming pools and spas (non-structural); detection and identification of illegal building work; detection and identification of illegal plumbing work; durability of exposed finishes; neighbourhood problems; document analysis; electrical installation; any matters that are solely regulated by statute; any area(s) or item(s) that could not be inspected by the consultant.

Accordingly, this Report is NOT a guarantee that defects and/or damage does not exist in any inaccessible or partly inaccessible areas or sections of the property.

NB. Such matters may, upon request, be covered under the terms of a 'Special-Purpose Property Report'.

4) Consumer Complaints Procedure: In the event of any dispute or claim arising out of, or relating to the Inspection or the Report, you must notify us as soon as possible of the dispute or claim by email, fax, or mail. You must allow us (which includes persons nominated by us) to visit the property (which visit must occur within twenty eight (28) days of your notification to us) and give us full access in order that we may fully investigate the complaint. You will be provided with a written response to your dispute or claim within twenty-eight (28) days of the date of the Inspection.

If you are not satisfied with our response, you must within twenty one (21) days of your receipt of our written response, refer the matter to a Mediator nominated by us from the Institute of Arbitrators and Mediators of Australia. The cost of the Mediator will be borne equally by both parties, and as agreed as part of the mediated settlement.

Should the dispute or claim not be resolved by mediation, then the dispute or claim will proceed to arbitration. The Institute of Arbitrators and Mediators of Australia will appoint an Arbitrator who will hear and resolve the dispute. The arbitration, subject to any directions of Arbitrator, will proceed in the following manner:

(a) The parties must submit all written submissions and evidence to the Arbitrator within twenty one (21) days of the appointment of the Arbitrator; and

(b) The arbitration will be held within twenty one (21) days of the Arbitrator receiving the written submissions.

The Arbitrator will make a decision determining the dispute or claim within twenty one (21) of the final day of the arbitration. The Arbitrator may, as part of his determination, determine what costs, if any, each of the parties are to pay and the time by which the parties must be paid any settlement or costs.

The decision of the Arbitrator is final and binding on both parties. Should the Arbitrator order either party to pay any settlement amount or costs to the other party but not specify a time for payment, then such payment shall be made within twenty one (21) days of the order.

NB. In the event that you do not comply with the above Complaints Procedure and commence litigation against us, then you agree to fully indemnify us against any awards, costs, legal fees, and expenses incurred by us in having your litigation set aside or adjourned to permit the foregoing Complaints Procedure to complete.

5) Asbestos Disclaimer: “No Inspection for Asbestos was carried out at the property, and no Report on the presence or absence of Asbestos is provided”.

Buildings built prior to 1982 may have wall and/or ceiling sheeting, and other products including roof sheeting that contains Asbestos. Even buildings built after this date, up until the early 90s, may contain some Asbestos. Sheeting should be fully sealed. If you are concerned, the building was built prior to 1990, or if asbestos is noted as present within the property, then you should seek advice from a qualified asbestos removal expert as to the amount and importance of the asbestos present and the cost of sealing or removal. Drilling, cutting, or removing sheeting or products containing Asbestos is a high risk to peoples’ health. You should seek advice from a qualified asbestos removal expert.

6) Mould (Mildew and non-wood decay fungi) Disclaimer: Mildew and non-wood decay fungi are commonly known as mould. However, mould and their spores may cause health problems or allergic reactions, such as asthma and dermatitis in some people. No Inspection for mould was carried out at the property, and no Report on the presence or absence of mould is provided. If mould is noted as present within the property, or if you notice mould and you are concerned as to the possible health risk resulting from its presence, then you should seek advice from your local Council, State or Commonwealth Government Health Department, or a qualified expert such as an Industry Hygienist.

7) Magnesite Flooring Disclaimer: No Inspection for Magnesite Flooring was carried out at the property, and no Report on the presence or absence of Magnesite Flooring is provided. You should ask the owner whether Magnesite Flooring is present and/or seek advice from a Structural Engineer.

8) Estimating Disclaimer: Any estimates provided in this Report are merely opinions of possible costs that could be encountered, based on the knowledge and experience of the inspector, and are not estimates in the sense of being a calculation of the likely costs to be incurred. The estimates are NOT a guarantee or quotation for work to be carried out. The actual cost is ultimately dependent upon the materials used, standard of work carried out, and what a contractor is prepared to do the work for. It is recommended in ALL instances that multiple independent quotes are sourced prior to any work being carried out. The inspector accepts no liability for any estimates provided throughout this Report.

9) Note: If the Client has any doubt about the purpose, scope, and acceptance criteria on which the Report was based please discuss your concerns with the Consultant on receipt of the Report. The Client acknowledges that, unless stated otherwise, the Client as a matter of urgency should implement any recommendation or advice given in this Report.

IMPORTANT DISCLAIMER

Disclaimer Liability: No Liability shall be accepted on an account of failure of the Report to notify any problems in the area(s) or section(s) of the subject property physically inaccessible for Inspection, or to which access for Inspection is denied by or to the Inspector (including but not limited to or any area(s) or section(s) so specified by the Report).

Disclaimer of Liability to Third Parties: Compensation will only be payable for losses arising in contract or tort sustained by the Client named on the front of this Report. Any third party acting or relying on this Report, in whole or in part, does so entirely at their own risk. However, if ordered by a Real Estate Agent or a Vendor for the purpose of auctioning a property, then the Inspection Report may be ordered up to seven (7) days prior to the auction, copies may be given out prior to the auction and the Report will have a life of 14 days during which time it may be transferred to the purchaser. Providing the purchaser agrees to the terms of this agreement, then they may rely on the Report subject to the terms and conditions of this agreement and the Report itself.

NB. In the ACT under the Civil Law (Sale of Residential Property) Act 2003 and Regulations, the Report resulting from this Inspection may be passed to the purchaser as part of the sale process, providing it is carried out no more than three months prior to listing and is not more than six months old.

Limited Liability to a Purchaser within the Australian Capital Territory only: Within the Australian Capital Territory (ACT) and in accordance with the ACT Civil Law (Sale of Residential Property) Act 2003 and Regulations, a copy of the Report may be attached to the Contract for Sale.

WARNING: The Purchaser is advised that this Report reflects the condition of the property existing at the time of the Inspection (Inspection Date) and may not reflect the current state. It is, therefore, very strongly recommended that you promptly arrange for another Inspection and Report in accordance with Australian Standard AS4349.1 to be carried out prior to the expiration of the 'Cooling off Period' and settlement.

This is not a Compliance Report strictly in accordance with Civil Law (Sale of Residential Property) Regulations: The Report may contain copies of any approved plans, building approvals, building permit and Certificates of Occupancy. However, any comments made by the person who prepared the Report as to whether or not, in the opinion of the Inspector, the structures on the land substantially comply with the approved plans (if any) are made on the basis of a cursory glance of the plans and not upon a detailed examination. Any opinion expressed as to whether or not any building approval or approval under the Land (Planning and Environment) Act, 1991, is based on the limited knowledge and belief, at the time, of the Inspector. The Purchaser is advised that a Special Purpose Report is available through the Inspector to advise more fully in respect to these matters. The structures may have been damaged by pests, storm, strong wind or fire or the Vendor may have carried out alterations and/or additions to the Property since the Inspection Date. The Report may no longer reflect the true condition of the Property. The structure(s) may no longer be in accordance with the attached plans etc. IT IS STRONGLY RECOMMENDED that, if the Purchaser has any concerns in respect to the compliance of the structures, a Special Purpose Report be obtained. Alternatively, the Purchaser should rely upon his, her or their own enquiries.

Contact the Inspector: Please feel free to contact the Inspector who carried out this Inspection. Often it is very difficult to fully explain situations, problems, access difficulties, building faults or their importance in a manner that is readily understandable by the reader. Should you have any difficulty in understanding anything contained within this Report, then you should immediately contact the Inspector and have the matter explained to you. If you have any questions at all, or require any clarification, then contact the Inspector prior to acting on this Report.

OTHER INSPECTIONS AND REPORTS REQUIRED

It is strongly recommended that the following Inspections and Reports be obtained prior to any decision to purchase the Property. Obtaining these Reports will better equip the purchaser to make an informed decision. Although appliances may be listed in the Report, they have not been tested as this is outside the scope of the standard Building Inspection. Other Inspections we recommend the purchaser obtains before making their decision are:

- Electrical Inspection,
- Plumbing Inspection,
- Structural (Engineer),
- Geotechnical Inspection,
- Drainage Inspection,
- Asbestos Inspection,
- Mould Inspection,
- Gas fitting Inspection,
- Appliances Inspection,
- Air-conditioning Inspection,
- Alarm/Intercom/Data Systems,
- Hydraulics Inspection,
- Mechanical Services,
- Hazards Inspection,
- Fire/Chimney Inspection,
- Estimating Report,
- Garage Door Mechanical,
- Durability exposed surfaces

SMOKE DETECTORS

The occupier/purchaser should satisfy themselves as to the working condition of the smoke detectors, if installed. It is highly recommended that suitable smoke detectors be installed in all residential properties. AS 3786 advises that smoke detectors are required for all buildings where people sleep. It is recommended that an electrician be consulted to advise on those installed or install these detectors.

CRACKING OF BUILDING ITEMS

Regardless of the type of crack(s), a Pre-Purchase Building Inspector carrying out a Pre-Purchase Inspection within the scope of a visual Inspection is unable to determine the expected consequences of the cracks.

Obtaining Information regarding the below all fall outside the scope of this Pre-Purchase Inspection:

- (a)** The nature of the foundation material on which the building is resting,
- (b)** The design of the footings,
- (c)** The site landscape,
- (d)** The history of the cracks and,
- (e)** Carrying out an invasive Inspection.

However, the information obtained from the five items above is valuable in determining the expected consequences of the cracking and any remedial work needed. Cracks that are small in width and length on the day of the Inspection may have the potential to develop over time into structural problems for the homeowner, resulting in major expensive rectification work being carried out. If cracks have been identified in the Report above, then a Structural Engineer is required to determine the significance of the cracking prior to a decision to purchase.

NOTICE TO THE PURCHASER (ACT ONLY)

(a) At the Exchange, and prior to the 'Cooling-off Period', you were given an Inspection Report on the property you intend on purchasing. This Report reflects the condition of the property existing at the time of the Inspection (Inspection Date) and may not reflect the current state. The structures may have been damaged by pests, storm, strong wind or fire or the vendor may have carried out alterations and/or additions to the property since the Inspection date. The Report may no longer reflect the true condition of the property. The structure(s) may no longer be in accordance with the attached plans etc. It is, therefore, very strongly recommended that you urgently arrange for another Inspection and Report in accordance with Australian Standard AS 4349.1 to be carried out prior to exchange, or prior to the expiration of any 'Cooling Off Period' and prior to settlement.

(b) If the Report indicated the presence of termite damage, or recommends any other Inspections or treatments, you should obtain copies of these Reports and any treatment proposals, certificates of treatment carried out, including details of all repairs including copies of quotations, invoices, and any other Reports. It is strongly recommended that you arrange for an Inspection and Report in accordance with AS 4349.3 to verify that the treatment has been successful and carried out in accordance with AS 3660.2, and a further building Inspection in accordance with AS 4349.1.

(c) If you fail to procure a further Inspection and Report as recommended in (a) and (b), or fail to obtain copies of other Reports, treatment proposals, certificates of treatment carried out, details of all repairs including copies of quotations, invoices and any other Reports as recommended in (b) above, then you agree that you have decided not to have a further Inspection and Report carried out, or to obtain copies of treatment proposals, certificates of treatment carried out, details of all repairs including copies of quotations, invoices and any other Reports and have relied upon your own enquires and the Report, knowing the possible consequences, and that the condition of the property, as stated in the Report, may have changed.

(d) You agree that the person carrying out the Inspection **and** the company, partnership or sole trader that employs that person will have no liability to you for any damage or loss you may suffer as a result of your entering the contract to purchase the property, or in connection with completing the purchase of the property as a result of your failure to heed the advice given in (a) and (b) and the warning contained in (c) above, and may use such failure in defense of any claim that you may later make against any of them.

NB. It is a condition of your right to rely upon the Report that you transmit by fax, post, or otherwise deliver the signed "Notice to the Purchaser" (ACT only) to the company, partnership or sole trader at the address detailed on the front of the Report not less than four (4) days prior to the date of settlement. If you fail to complete, sign, or deliver the Notice then it will be deemed that you did not rely upon the report in respect to your decision as to whether or not to purchase the property. This may seriously affect any rights to future compensation to which you may be entitled.

Please cross out the statement below that does not apply: - At the date of settlement, not more than 180 days will have elapsed since the Inspection date.

1. I/We have read and understood the 'Limited Liability to a Purchaser within the Australian Capital Territory only' clause of the Report, and this Notice to the Purchaser. I/We have not arranged for another inspection and report in respect of the property, and it is my/our intention to **rely upon the findings contained in the report**; or

2. I/We have **arranged for another Inspection of the Property and Report** to be carried out, which I/We will use in conjunction with this Report in deciding whether to proceed with the purchase of the property; or

3. I/We have read and understood the 'Limited Liability to a Purchaser within the Australian Capital Territory only' clause of the Report, and this Notice to the Purchaser. I/We have not arranged for another Inspection and Report in respect of the property and have **relied on my/our own enquiries in respect of the condition of the property** as at the date of settlement including any changes in the condition of the property that have taken place since the Inspection date stated in the Report

Timber Pest Report



SUMMARY SHEET

Property Address: 97 Fitchett Street, Garran ACT 2605
Client: Hutchinson
Inspection Date: Thursday, May 7th 2026
Inspection carried out by: Ned Strickland

This summary is supplied to allow a quick and superficial overview of the Inspection results. This summary is NOT the Report and cannot be relied upon on its own. This summary must be read in conjunction with the full Report and not in isolation from the Report. If there should happen to be any discrepancy between anything in the Report, and anything in this summary, the information in the Report shall override that in the summary. The Report is subject to conditions and limitations. Your attention is particularly drawn to the clauses, disclaimer of liability to third parties, limited liability to a purchaser with the Australian Capital Territory (ACT), and to the notice to the purchaser at the back of this Report.

1.0 ACCESS LIMITATIONS

There were access limitations to the inspection/report. Please refer to section 1.0 of the report.

2.0 TERMITE ACTIVITY

No active subterranean termites (live specimens) were found.

No visible evidence of subterranean termite workings or damage was found.

3.0 BORER ACTIVITY

Visible evidence of borers of seasoned timbers was found. Please refer to section 3.0 of the Pest Report for further information.

4.0 DECAY FUNGI

No evidence of damage caused by wood decay (rot) fungi was found.

For complete and accurate information, please refer to the attached 'Visual Timber Pest Report', which is prepared in accordance with AS 4349.3.

CONDITIONS OF THIS INSPECTION

Important Information:

Any person who relies upon the contents of this Report does so acknowledging that the following clauses, which define the scope and limitations of the Inspection, form an integral part of the Report.

This is a **Visual Inspection Only**, prepared in accordance with AS 4349.3, 'Inspection of Buildings Part 3: Timber Pest Inspections'. Visual Inspection was limited to those areas and sections of the property to which reasonable access (see definition) was both available and permitted on the date of Inspection.

The Inspection **did not** include breaking apart, dismantling, removing, or moving objects including but not limited to – foliage, mouldings, roof insulation/sisalation, floor or wall coverings, sidings, ceilings, floors, furnishings, appliances, or personal possessions.

The Inspector **cannot** see inside walls, between floors, inside skillion roofing, inside the eaves, behind stored goods in cupboards, or in any other areas that are concealed or obstructed.

The Inspector **did not** dig, gouge, force or perform any other invasive procedures. An invasive Inspection will not be performed unless a separate contract is entered into.

In an occupied property, it must be understood that furnishings or household items may be concealing evidence of Timber Pests, which may only be revealed when the items are moved or removed.

In the case of strata type properties, only the interior of the unit is inspected.

Scope of Report:

This Report only deals with the detection or non-detection of Timber Pest Attack and Conditions Conducive to Timber Pest Attack discernible at the time of inspection. The inspection was limited to the Readily Accessible Areas of the Building and Site (see note below) and was based on a visual examination of surface work (excluding furniture and stored items), and the carrying out of Tests. Note. With strata and company title properties, the inspection was limited to the interior and the immediate exterior of the particular residence inspected. Common property was not inspected.

Limitations:

The Client acknowledges:

(a) This Report does not include the inspection and assessment of matters outside the scope of the requested inspection and report.

(b) The inspection only covered the Readily Accessible Areas of the Building and Site. The inspection did not include areas which were inaccessible, not readily accessible or obstructed at the time of inspection. Obstructions are defined as any condition or physical limitation which inhibits or prevents inspection and may include – but are not limited to – roofing, fixed ceilings, wall linings, floor coverings, fixtures, fittings, furniture, clothes, stored articles/materials, thermal insulation, sarking, pipe/duct work, builder's debris, vegetation, pavements, or earth.

(c) The detection of dry wood termites may be extremely difficult due to the small size of the colonies. No warranty of absence of these termites is given.

(d) European House Borer (*Hylotrupes bajulus*) attack is difficult to detect in the early stages of infestation as the galleries of boring larvae rarely break through the affected timber surface. No warranty of absence of these borers is given. Regular inspections including the carrying out of appropriate tests are required to help monitor susceptible timbers.

(e) This is not a structural damage report. Neither is this a warranty as to the absence of Timber Pest Attack.

(f) If the inspection was limited to any particular type(s) of timber pest (e.g., subterranean termites), then this would be the subject of a Special-Purpose Inspection Report, which is adequately specified.

(g) This Report does not cover or deal with environmental risk assessment or biological risks not associated with Timber Pests (e.g., toxic Mould) or occupational, health or safety issues. Such advice may be the subject of a Special-Purpose Inspection Report which is adequately specified and must be undertaken by an appropriately qualified inspector. The choice of such inspector is a matter for the Client.

(h) This Report has been produced for the use of the Client. The Consultant or their firm or company are not liable for any reliance placed on this report by any third party, except as provided in the section Limited Liability To a Purchaser within the Australian Capital Territory.

Determining extent of Damage:

This is not a structural building report, and any inexpert opinion we provide on timber damage cannot be relied upon. This Report **will not** state the full extent of any Timber Pest damage. It will state Timber Pest Damage found as either 'slight', 'moderate', 'moderate to extensive', or 'extensive', and this information is not the opinion of an expert. If any evidence of Timber Pest activity and/or damage resulting from Timber Pest activity is reported, either in the structure(s) or the grounds of the property, then you must assume that there may be concealed structural damage within the building(s).

This concealed damage may only be found when wall linings, cladding or insulation are removed to reveal previously concealed timbers. In this case, an Invasive Timber Pest Inspection (for which a separate contract is required) is strongly recommended, and you should arrange for a qualified professional such as a builder, engineer, or architect to carry out a structural Inspection to determine the full extent of the damage, and the extent of repairs that may be required. You agree that neither we, nor the individual conducting the Inspection, are responsible or liable for the repair of any damage, whether disclosed by the Report or not.

Disclaimer of Liability:

No liability shall be accepted on account of failure of the Report to notify any termite activity and/or damage present at, or prior to, the date of the Report, in any area(s) or section(s) of the subject property physically inaccessible for Inspection, or to which access for Inspection is denied by, or to, the licensed Inspector (including, but not limited to, any area(s) or section(s) specified by the Report).

1.0 ACCESS LIMITATIONS

1.1 Area(s) inspected:

Only structures, fences &/or trees within 50m of the building but within the property boundaries were inspected.

1.2 Common area(s) not inspected:

No Inspection was made, and no Report will be submitted, of inaccessible area(s).

These include, but may not be limited to; cavity walls, concealed frame timbers, eaves, flat roofs, fully enclosed patios, inaccessible parts of the subfloors, inaccessible parts of the roof void, soil concealed by concrete floors, fireplace hearths, wall linings, landscaping, rubbish, floor coverings, furniture, pictures, appliances, stored items, insulation, and hollow blocks/posts etc.

1.3 Area(s) in which visual inspection was obstructed or restricted and why:

Ceiling framing timbers were concealed by insulation. The visual inspection of the subfloor framing was restricted due to underfloor insulation and stored items. Areas of the timber fence were concealed by vegetation. The inspection of the garage was restricted due to stored goods being kept in the area at the time of inspection. No inspection was made to sections of the residence and/or structures built on the side boundary.

NB. Please note that since a complete Inspection of the above area(s) was not possible, Timber Pest activity and/or damage may exist in these areas.

1.4 The property was furnished at the time of inspection.

Where a property is furnished at the time of Inspection, it must be understood that the furnishings and stored goods may be concealing evidence of Timber Pest activity. This evidence may be revealed when the property is vacated, and a further Inspection of the vacant property is strongly recommended if the house was furnished at the time of inspection.

1.5 Undetected timber pest risk assessment is considered Moderate.

NB. Where the risk is considered "Moderate" or "Moderate-High" or "High", a further inspection is strongly recommended of areas that were not readily accessible, and of inaccessible or obstructed areas once access has been provided or the obstruction removed. This may require the moving, lifting or removal of obstructions such as floor coverings, furniture, stored items foliage and insulation. In some instances, it may also require the removal of ceiling and wall linings, and the cutting of traps and access holes. Seek further advice from your Consultant.

2.0 TERMITE ACTIVITY

2.1 No active (live) termites were present at the time of Inspection.

2.2 No visible evidence of subterranean termite workings and/or damage was found.

2.3 A termite nest was not found.

2.4 No evidence of timber damage caused by Termite attack was visible at the time of the Inspection.

NB. Where evidence of termite activity by the *Nasutitermes* or *Coptotermes* species was found in the grounds, the risk to buildings is very high. A treatment to eradicate the termites and to protect the building(s) should be carried out. Where the evidence of termite workings was found in the grounds or the building(s), then the risk of a further attack is very high.

2.5 Very important:

If live termites or any evidence of termite workings or damage was reported above, within the building(s) or in the grounds and fences, then it must be assumed that there may be concealed termite activity and/or timber damage. This concealed activity or damage may only be found when alterations are carried out, such as when wall linings, cladding or insulation are removed; or if you arrange for an invasive Inspection. We claim no expertise in structural engineering or building, and we strongly recommend that you have a qualified professional such as a builder, engineer, architect, or other qualified expert determine the full extent of the damage, if any. This may require an invasive Inspection. We take no responsibility for the repair of any damage, whether disclosed by this Report or not (see 'Terms and Limitations').

Where visual evidence of termite workings and/or damage is reported above, but no live termites were present at the time of Inspection, you must realise that it is possible that termites are still active in the immediate vicinity, and that the termites may continue to cause further damage. It is not possible, without further investigation and a number of Inspections over a period of time, to ascertain whether any infestation is active or inactive. Active termites may simply have not been present at the time of Inspection due to a prior disturbance or climatic conditions, or they may have been utilizing an alternative feeding source.

Continued, regular Inspections are essential. Unless written evidence of a termite protection program in accordance with 'AS 3660' with ongoing Inspections is provided, you must arrange for a treatment in accordance with 'AS 3660' to be carried out to reduce the risk of further attack.

2.6 Previous termite treatment: There were no signs of a termite treatment or evidence of a possible previous termite treatment, at the time of inspection.

NB. If there is evidence of drill holes in concrete or brickwork, bait stations or other signs of a possible previous treatment are reported, then the treatment was probably carried out because of an active termite attack. Extensive structural damage may exist in concealed areas. You should have an invasive Inspection carried out, and have a builder determine the full extent of any damage, and the estimated cost of repairs, as the damage may only be found when wall linings etc. are removed. Normally, if a termite treatment has been carried out, then a durable notice should be located in the metre box, indicating the type of termite shield system, treated zone or combination that has been installed.

2.7 Termite management: A durable notice (termite management notice) was not found during the inspection, indicating a barrier system has not been installed.

This firm can give no assurances with regard to work that may have been previously performed by other firms. You should obtain copies of all paperwork and make your own enquiries as to the quality of the treatment when it was carried out, and warranty information. In most cases, you should arrange for a treatment in accordance with "Australian Standard 3660" to be carried out to reduce the risk of further attack.

2.8 General remarks:

Where any current visible evidence of Timber Pest activity is found, it is strongly recommended that a more invasive Inspection be performed. Trees on and near the property up to a height of 2 metres, have been visually Inspected where possible and practicable, for evidence of Termite activity. It is very difficult to locate termite nests since they are underground, and evidence in trees is usually well concealed. Therefore, we strongly recommend that you arrange to have the medium to large eucalypt trees within a 50 metre radius of the property test drilled for evidence of termite nests.

3.0 BORER ACTIVITY

3.1 Lyctus borer workings was found in several timber bearers and joists in the roof framing timbers. The damage has been caused by Lyctus brunneus (powderpost beetle) and is not of structural concern. No repairs or treatment are required.

The **Lyctid Borer** - The most common lyctid borer in Australia is **Lyctus brunneus (powder post beetle)**. Attack usually takes place during the first six to twelve months of the service life of timber. However, the powder post beetle is not considered a significant pest of timber and treatment of infestation is not usually required. As only the sapwood of certain hardwoods is destroyed, larger-dimensional timbers (such as rafters, bearers, and joists) in a building are seldom weakened significantly to cause collapse. The **Anobiid Borer** There are many different species of Anobiid borer, the most frequently encountered being *Anobium punctatum* (furniture beetle) and *Calymnaderus incisus* (Queensland pine beetle). Attack mainly occurs to softwoods especially pine timbers such as floorboards that have been in service for at least ten years. Should any structural timbers be attacked by Anobiid borers it is often difficult to determine what extent the borer damage has weakened such timbers and replacement is often the only way of ensuring safety from collapse.

In the case of Anobiid borers, once an attack is initiated it is unlikely to cease or die out of its own accord without some sort of eradication treatment. Therefore, unless proof of treatment is provided, evidence of an attack must always be considered active. Although a chemical treatment is an option, replacement of infested timbers with non-susceptible, or treated timber, is the most effective method of treatment. Before any option is considered, competent advice (e.g., from a licensed building contractor) should be sought to determine the extent of any structural damage, and as to the need or otherwise for rectification or repair work.

Other Borers: A further (more invasive) investigation is strongly recommended to determine whether infestation is still active and to positively identify the borer species responsible for the attack. Always seek further advice from the Consultant.

Management Program: Wherever practical, remove any conditions conducive to attack (e.g., *Anobium* borer thrive in badly ventilated subfloor areas). Regular inspections are recommended at intervals not exceeding 12 months. Always seek further advice from the Consultant.

4.0 DECAY FUNGI

4.1 No evidence of damage caused by wood decay (rot) fungi was found.

NB. If any evidence of fungal decay or damage is reported, you should consult a building expert to determine the full extent of damage, and the estimated cost of repairs or timber.

General Description of Attack Decaying wood contains sufficient moisture to retain its original shape and may have sufficient strength to withstand normal loads. In contrast decayed wood is reduced both in moisture content and size as indicated by cracking either along or across the grain or fibres coming apart in a stringy manner. Decayed wood will have undergone considerable strength reduction.

Economic Significance Fungal decay can cause at one extreme, structural failure of the affected timber, and at the other purely superficial surface damage. The most critical determination is that of which timber is affected and decaying because decay will most likely spread (unless sources of moisture are quickly removed). Affected and decayed timber may warrant timber replacement, but the rot should not spread unless a new moisture source becomes available in that area.

Where evidence of decayed timber exists, competent advice (e.g., from a licensed or registered building contractor) should be sought to determine the extent of any structural damage, and as to the need or otherwise for rectification or repair work. It is important to correct any condition conducive to attack prior to replacing decayed wood.

Where evidence of decaying timber exists, competent advice (e.g., from a licensed or registered building contractor) should be sought to remove the condition(s) conducive to attack, and to determine the extent of any structural damage, and as to the need or otherwise for rectification or repair work.

Where the full extent of damage or the overall condition of the timber is undetermined a further inspection is strongly recommended by a competent person (e.g., from a licensed or registered building contractor). This may require monitoring of the timber over a period and include the assessment of conditions conducive to attack in different weather conditions (e.g., to determine the adequacy of existing drainage).

Management Program Remove any conditions conducive to attack (e.g., lack of ventilation or the presence of excessive moisture). Regular inspections are recommended at intervals not exceeding 12 months. Always seek further advice from the Consultant.

5.0 CONDITIONS THAT ARE CONDUCTIVE TO TIMBER PESTS

5.1 Water leaks: At the time of the inspection no leaks were found to be present.

Water leaks, especially in or into the subfloor, or against the external walls; increase the likelihood of termite attack. Leaking showers or leaks from other 'wet areas' also increase the likelihood of concealed termite attack. Hot water overflows should be plumbed away from the building.

NB. We claim no expertise in building, and if any leaks were reported, you should consult a plumber or other building expert to determine the full extent of damage, and the estimated cost of repairs.

5.2 Moisture/drainage: At the time of the inspection, the subfloor soil was generally dry.

Lack of Adequate Subfloor Ventilation Inadequate ventilation provides a condition suitable for timber pest infestation. For example, subterranean termites thrive in damp humid conditions typical of those provided in a poorly ventilated subfloor space. Where evidence of a lack of adequate ventilation has been identified in the report, the Client should seek competent advice (e.g., from a licensed or registered building contractor) regarding upgrading ventilation. The Presence of Excessive Moisture Ground levels around the building should be maintained in such a way to minimise water entering under the building. Also, the ground surface in subfloor areas should be kept graded to ensure that moisture does not pond or accumulate in any area. Where necessary, sub-surface drains should be installed and maintained to assist with drainage around and under the building. Likewise, the presence of excessive moisture can often be directly related to ventilation limitations and the resultant high humidity. Also, plumbing oversights and defects such as a leaking drain or tap will provide a microclimate conducive to timber pest attack. Where necessary, the Client should seek competent advice (e.g., from a licensed or registered plumbing contractor) to determine the adequacy of existing drainage and remove any conditions conducive to the presence of excessive moisture. The building may need to be monitored over a period of time to detect or confirm a damp problem. The presence of dampness (including moisture) is not always consistent as the prevailing and recent weather conditions at the time an inspection is carried out may affect the detection of damp problems. Importantly, precipitation at or near the time of inspection does not necessarily guarantee that a damp problem will automatically be evident due to such circumstances as prevailing wind conditions or intensity of rainfall. The absence of any dampness at the time of inspection does not necessarily mean the building will not experience some damp problems in other weather conditions. Likewise, whether services have been used for some time prior to an inspection being carried out will affect the detection of dampness.

5.3 Ventilation: Restricted, due to the cavity brick construction of the house with internal brick walls in the subfloor region minimising cross ventilation.

Lack of Adequate Subfloor Ventilation Inadequate ventilation provides a condition suitable for timber pest infestation. For example, subterranean termites thrive in damp humid conditions typical of those provided in a poorly ventilated subfloor space. Where evidence of a lack of adequate ventilation has been identified in the report, the Client should seek competent advice (e.g., from a licensed or registered building contractor) in regard to upgrading ventilation.

5.4 Hot water services and air conditioning units: There is no need for this work to be carried out.

Hot water services and air conditioning units which release water alongside or near to building walls should be piped to a drain (if not possible then several metres away from the building), as the resulting wet area is highly conducive to termites.

5.5 Slab edge exposure: The slab edge inspection zone does not apply to this property.

Where external concrete slab edges are not exposed, there is a high risk of concealed termite entry.

In some buildings built since July 1995, the edge of the slab forms part of the termite shield system. In these buildings an Inspection zone of at least 75mm should be maintained to permit detection of termite entry. The edge should not be concealed by render, tiles, cladding, flashings, adjoining structures, paving, soil, turf, or landscaping etc. Where this is the case, you should arrange to have the slab edge exposed for Inspection.

Concealed termite entry may already be taking place but could not be detected at the time of the Inspection. This may have resulted in concealed timber damage.

NB. A very high proportion of termite attacks are over the slab edge. Covering the slab edge makes concealed entry easy. This is particularly true of infill type slab construction. Termite activity and/or damage may be present in concealed timbers of the building. We strongly recommend frequent regular inspections in accordance with AS 3660.2.

5.6 Weep holes in external walls: Weep holes are not applicable to this property.

It is very important that soil, lawn, concrete paths, or pavers do not cover the weep holes. Sometimes, they have been covered during the rendering of the brick work. They should be clean and free flowing and covering the weep holes in part or in whole may allow undetected termite entry.

5.7 Termite shields: Inadequate, as ant capping is not continuous. This is typical for a home of this age.

Termite Shields (Ant Caps) should be in good order and condition, so termite workings are exposed and visible. This helps prevent termites from gaining undetected entry. Joints in the shielding should have been soldered during the installation. If it is observed that the joints in the shielding have not been soldered, then the shielding must be reported as inadequate. It may be possible for a builder to repair the shielding. If not, a chemical treated zone may need to be installed to deter termites from gaining concealed access to the building. Missing, damaged or poor shields increase the risk of termite infestation. If considered inadequate, a builder or other building expert should be consulted.

Other physical shield systems are not visible to inspection and no comment is made on such systems.

5.8 Bridging or breaching of termite barriers and inspection zones: No bridging or breaching was found.

“Bridging” is the spanning of a termite barrier or inspection zone so that subterranean termites are provided with passage over or around that barrier. “Breaching” is the making of a hole or gap in a termite barrier so that termites are provided with a passage through that barrier.

5.9 Other area(s) and/or situations that appear conducive to (may attract) subterranean termite infestation: Medium to large trees and stumps within a 50 metre radius of the property, due to the nesting conditions. The form work timbers in the subfloor region, as these timbers are in direct contact with the ground, allowing timber pests to gain direct access to the house structure. Several timber off cuts on the ground in the subfloor, due to the ideal food source.

6.0 OVERALL ASSESSMENT OF THE PROPERTY

6.1 Where evidence of live termites, termite damage or termite workings (mudding) was found in the building(s) then the risk of a further attack is extremely high.

Where evidence of live termites, termite damage or termite workings was found in the grounds but not in the building(s) then the risk to buildings must be reported as high to extremely high.

6.2 At the time of the Inspection, the degree of risk of subterranean termite infestation to the overall property was considered to be **Moderate to High**.

6.3 Subterranean Termite Treatment Recommendation: A management program in accordance with AS 3660-2000 to protect against subterranean termites is considered **not essential, but 6 to 12 monthly inspections are essential**.

6.4 Future Inspections: AS 3660.0-2000 recommends “regular competent Inspections should be carried out at least on an annual basis, but more frequent Inspections are strongly recommended”.

It goes on to inform that “regular Inspections will not prevent termite attack but may help in the detection of termite activity. Early detection will allow remedial treatment to be commenced sooner, and damage to be minimized”.

Due to the degree of risk of subterranean termite infestation noted above and all other findings of this Report; we strongly recommend that a full Inspection and written Report in accordance with AS 4349.3 or AS 3660.2-2000 is conducted at this property every 6 months, but no more than 12 months.

DEFINITIONS

Timber Pest Attack: Means Timber Pest Activity and/or Timber Pest Damage.

Timber Pest Activity: Means telltale signs associated with 'active' (live) and/or 'inactive' (absence of live) Timber Pests at the time of inspection.

Timber Pest Damage: Means noticeable impairments to the integrity of timber and other susceptible materials resulting from attack by Timber Pests.

Major Safety Hazard: Means any item that may constitute an immediate or imminent risk to life, health or property resulting directly from Timber Pest Attack. Occupational, health and safety or any other consequence of these hazards has not been assessed.

Conditions Conducive to Timber Pest Attack: Means noticeable building deficiencies or environmental factors that may contribute to the presence of Timber Pests.

Readily Accessible Areas: Means areas which can be easily and safely inspected without injury to person or property, are up to 3.6 metres above ground or floor levels, in roof spaces where the minimum area of accessibility is not less than 600 mm high by 600 mm wide and subfloor spaces where the minimum area of accessibility is not less than 400 mm high by 600 mm wide, providing the spaces or areas permit entry. The term 'readily accessible' also includes accessible subfloor areas on a sloping site where the minimum clearance is not less than 150 mm high, provided that the area is not more than 2 metres from a point with conforming clearance (i.e., 400 mm high by 600 mm wide); and areas at the eaves of accessible roof spaces that are within the consultant's unobstructed line of sight and within arm's length from a point with conforming clearance (i.e. 600 mm high by 600 mm wide).

Client: Means the person or persons for whom the Timber Pest Detection Report was carried out or their Principal (i.e., the person or persons for whom the report was being obtained).

Timber Pest Detection Consultant: Means a person who meets the minimum skills requirement set out in the current Australian Standard AS 4349.3 Inspections of Buildings. Part 3: Timber Pest Inspection Reports or state/territory legislation requirements beyond this Standard, where applicable.

Building and Site: Means the main building (or main buildings in the case of a building complex) and all timber structures (such as outbuildings, landscaping, retaining walls, fences, bridges, trees, and stumps with a diameter greater than 100 mm and timber embedded in soil) and the land within the property boundaries up to a distance of 50 metres from the main building(s).

Timber Pests: Means one or more of the following woods destroying agents which attack timber in service and affect its structural properties:

Chemical Delignification: The breakdown of timber through chemical action.

Fungal Decay: The microbiological degradation of timber caused by soft rot fungi and decay fungi, but does not include Mould, which is a type of fungus that does not structurally damage wood.

Wood Borers: Wood destroying insects belonging to the order 'Coleoptera' which commonly attack seasoned timber.

Termites: Wood destroying insects belonging to the order 'Isoptera' which commonly attack seasoned timber.

Tests: Means additional attention to the visual examination was given to those accessible areas which the consultant's experience has shown to be particularly susceptible to attack by Timber Pests. Instrument testing of those areas and other visible accessible timbers/materials/areas showing evidence of attack was performed.

Instrument Testing: Means where appropriate the carrying out of Tests using the following techniques and instruments:

- (a) Electronic moisture detecting meter - an instrument used for assessing the moisture content of building elements.
- (b) Stethoscope - an instrument used to hear sounds made by termites within building elements.
- (c) Probing - a technique where timber and other materials/areas are penetrated with a sharp instrument (e.g., bradawl or pocket knife), but does not include probing of decorative timbers or finishes, or the drilling of timber and trees; and
- (d) Sounding - a technique where timber is tapped with a solid object.

IMPORTANT MAINTENANCE ADVICE REGARDING INTEGRATED PEST MANAGEMENT FOR PROTECTING AGAINST TIMBER PESTS

You should read and understand the following important information. It will help explain what is involved in a Timber Pest Inspection, the difficulties faced by a Timber Pest Inspector, and why it is not possible to guarantee that a property is free of Timber Pests. It also details important information about what you can do to help protect your property from Timber Pests. This information forms an integral part of the Report. Any structure can be attacked by Timber Pests. Periodic maintenance should include measures to minimise possibilities of infestation in and around a property. Factors which may lead to infestation from Timber Pests include situations where the edge of the concrete slab is covered by soil or garden debris, filled areas, areas with less than 400mm clearance, foam insulation at foundations, earth/wood contact, damp areas, leaking pipes, etc.; form-work timbers, scrap timber, tree stumps, mulch, tree branches touching the structure, wood rot, etc. Gardens, pathways, or turf abutting or concealing the edge of a concrete slab will allow for concealed entry by timber pests any timber in contact with soil such as form-work, scrap timbers or stumps must be removed from under and around the buildings and any leaks repaired. You should endeavor to ensure such conditions DO NOT occur around your property. We further advise that you engage a professional pest control firm to provide a termite management program in accord with AS 3660 to minimise the risk of termite attack. There is no way of preventing termite attack. Even AS 3660 advises that "the provision of a complete termite barrier will impede and discourage termite entry into a building. It cannot prevent termite attack. Termites can still bridge or breach barriers, but they can be detected more readily during routine inspections."

Reasonable access:

Unless specified in writing, the inspection only covered the Readily Accessible Areas of the Building and Site.

The inspection did not include areas which were inaccessible, not readily accessible or obstructed at the time of inspection. Areas which are not normally accessible were not inspected and include - but not limited to – inside walls, the interior of a flat roof or beneath a suspended floor filled with earth.

Building Interior, the Consultant did not move or remove any ceilings, wall coverings, flooring, floor coverings (including carpeting), furnishing, equipment, appliances, pictures, or other household goods. In an occupied property, furnishings or household items may be concealing evidence of timber pest attack which may only be revealed when the items are moved or removed.

Building Exterior, Roof Exterior and Site, the Consultant did not move or remove any obstructions such as wall cladding, awnings, trellis, earth, plants, bushes, foliage, stored materials, debris, or rubbish. Due to the 'secretive' nature of timber pests, it is possible that hidden damage may exist in concealed areas, e.g., wall framing. Damage may only be found when the obstruction is removed. In the case of buildings constructed on concrete slabs, if the edge of the slab or any weep hole or vent at the base of external walls is concealed by pavements, gardens, lawns, or landscaping then it is possible for termites to gain undetected entry into the building. The building of gardens or planting of shrubs close to the perimeter of the building can promote and conceal termite entry points. The storage of cellulose materials such as building materials and firewood near the ground or building may encourage termite activity.

Roof Space Obstructions such as roofing, stored articles, thermal insulation, sarking, and pipe/duct work may be concealing evidence of timber pest attack which may only be revealed when the obstructions are moved or removed. Also, bodily access should be provided to the interior of all accessible roof spaces. In accordance with Australian Standard ASS 4349 the minimum requirement is a 400mm by 500 mm access manhole.

Subfloor Space Subfloor areas should be kept free from all vegetation (including tree stumps) and other cellulose material which may encourage timber pest activity. Also, storage of materials in subfloor areas is not recommended as it reduces ventilation and makes inspection difficult. Obstructions may be concealing evidence of timber pest attack which may only be revealed when the obstructions are moved or removed. Bodily access should be provided to all accessible subfloor areas with the minimum requirement being a 500 mm x 400 mm access manhole. In the case of suspended floors, if the clearance between the ground and structural components is less than 400 mm, then the ground should be excavated to provide the required clearance, subject to maintaining adequate drainage and support to footings. If the subfloor has been sprayed for subterranean termites or if the area is susceptible to mould growth, appropriate health precautions must be followed before entering the area. Also, special care should be taken not to disturb the treated soil. Always seek further advice from the Consultant.

A further inspection is strongly recommended of those areas that were not readily accessible and of inaccessible or obstructed areas once access has been provided or the obstruction removed. This will involve a separate visit to the site, permission from the owner of the property and additional cost.

Unless stated otherwise, any recommendation or advice given in this Report should be implemented as a matter of urgency.

A more invasive physical inspection is available and recommended:

As detailed above, there are many limitations to this visual inspection only. With the permission of the owner of the premises we WILL perform a more invasive physical inspection that involves moving or lifting insulation, stored items, furniture, or foliage during the inspection. We WILL physically touch, tap, test and when necessary, force/gouge suspected accessible timbers. We WILL gain access to areas, where physically possible and considered practical and necessary, by way of cutting traps and access holes.

This style of Report is available by ordering with several days' notice. Inspection time for this style of Report will be greater than for a VISUAL INSPECTION.

It involves disruption in the case of an occupied property, and some permanent marking is likely. You must arrange for the written permission of the owner who must acknowledge all the above information and confirm that our firm will not be held liable for any damage caused to the property.

A price is available on request.

Concrete slab homes:

Homes constructed on concrete slabs pose special problems with respect to termite attack. If the edge of the slab is concealed by concrete paths, patios, pavers, garden beds, lawns, foliage, etc. then it is possible for termites to affect concealed entry into the property, and they can then cause extensive damage to concealed framing timbers. Even the most experienced Inspector may be unable to detect their presence due to concealment by wall linings. Only when the termites attack timbers in the roof void, which may in turn be concealed by insulation, can their presence be detected. Where termite damage is in the roof, it should be expected that concealed framing timbers will be extensively damaged. With a concrete slab home, it is imperative that you expose the edge of the slab and ensure that foliage and garden beds do not cover the slab edge. Weep holes must be kept free of obstructions.

It is strongly recommended that you have a Termite Inspection in accordance with AS 3660.2 carried out every 6 to 12 months.

Subterranean termites:

No property is safe from termites. General Description of Attack Timber hollowed beneath; some cracking at the surface of timber; earthen channels present; or pale faecal spots present.

Important note:

As a delay may exist between the time of an attack and the appearance of telltale signs associated with the attack, it is possible that termite activity and damage exists though not discernible at the time of inspection.

Treatment After discovery of an active infestation, it is imperative that the species of termite is accurately identified before costly (and sometimes unnecessary or inappropriate) methods of treatment are initiated. Only economically important species which are known to attack timber structures should be treated.

In the case of economically important species, it is important that the termite workings are not further disturbed until the proposed method of control has been determined by a licensed pest control operator. Premature attempts to repair or replace infested timber may cause the termites to withdraw from the area temporarily, thereby hindering effective treatment. Any repair or replacement of infested timber should be carried out after the appropriate treatment has been completed.

Where evidence of active termites is detected within a building or within 50 metres of any building, it must always be assumed that the termites may also be active in areas of the property not inspected. Accordingly, where the termites are known to be of economic significance, a further (more invasive) inspection is strongly recommended of areas which were inaccessible, not readily accessible or obstructed at the time of inspection.

Termite Workings and Damage Where evidence of damage to building timbers exists, competent advice (e.g. from a licensed or registered building contractor) should be obtained to determine the extent of any structural damage and as to the need or otherwise for rectification or repair work.

Where evidence of inactive termites is located within the building, it is possible that termites are still active in areas of the property not inspected and they may continue to cause damage. A furthermore invasive inspection is strongly recommended of areas which were inaccessible, not readily accessible or obstructed at the time of inspection.

Where evidence of an inactive termite infestation exists, it is not possible, without benefit of further investigation and inspections over a period, to ascertain whether any infestation is active or inactive. Continued, regular, inspections are essential.

Where evidence of termite attack exists to any trees or tree stumps a more conclusive search should be undertaken. This may require the tree or stump to be drilled to determine the existence of a termite nest. In addition, the soundness and stability of any standing trees identified as being affected by termite attack should be confirmed. Always seek further advice from the Consultant.

Previous Treatments Where evidence of a possible termite treatment was located, the Client should obtain and keep on file all relevant documents pertaining to the extent of the treatment, any service warranties and advice in regard to the building owner's obligation to maintain the treatment and/or barrier. If evidence of a previous treatment of termite infestation is noted, and appropriate documentation is not available, the Client must assume that the termite infestation may still be active in areas of the property not inspected. Accordingly, a re-treatment may be required. Always seek further advice from the Consultant.

Frequency of Future Inspections Australian Standard AS 3660 recognises that regular inspections will not prevent termite attack but may help in the detection of termite activity. Early detection will allow remedial treatment to be commenced sooner and damage to be minimised.

Inspections at intervals not exceeding twelve (12) months are recommended. Where the termite risk is high or the building type susceptible to termite attack, more frequent inspections (3-6 months) should be undertaken.

Risk management options:

To help protect against financial loss, it is essential that the building owner immediately control or rectify any evidence of destructive timber pest activity or damage identified in this inspection report. The Client should further investigate any high-risk area where access was not gained. It is strongly advised that appropriate steps be taken to remove, rectify or monitor any evidence of conditions conducive to timber pest attack.

To help minimise the risk of any future loss, the Client should consider whether the following options to further protect their investment against timber pest infestation are appropriate for their circumstances:

Undertake thorough regular inspections at intervals not exceeding twelve months or more frequent inspections where the risk of timber pest attack is high, or the building type is susceptible to attack. To further reduce the risk of subterranean termite attacks, implement a management program in accordance with Australian Standard AS 3660. This may include the installation of a monitoring and/or baiting system, or chemical and/or physical barrier. However, AS 3660 stresses that subterranean termites can bridge, or breach barrier systems and inspection zones and that thorough regular inspection of the building are necessary.

CONTACT THE INSPECTOR

Please feel free to contact the Inspector who carried out this inspection. Often it is very difficult to fully explain situations, problems, access difficulties or timber pest activity and/or damage in a manner that is readily understandable by the reader. Should you have any difficulty in understanding anything contained within this Report, then you should immediately contact the Inspector and have the matter explained to you.

If you have any questions at all or require any clarification, then contact the Inspector prior to acting on this Report.

NOTICE TO THE PURCHASER

(a) Prior to or on Exchange, and prior to the commencement of the 'Cooling-off Period', you were given an Inspection Report on the Property you intend on purchasing ("the Report"). The Purchaser is advised that this Report reflects the condition of the property existing at the time of the Inspection (Inspection Date) and may not reflect the current state. Timber Pests, particularly Termites, may have gained entry to the property since the Inspection Date. Termites can, in a relatively short period, cause significant damage to both structural and non-structural timbers within and around the buildings of the Property.

Termites (white ants) may be difficult to detect and much of the damage caused may not be readily visible. If damage exists, then it may cost thousands of dollars to repair.

It is, therefore, very strongly recommended that you urgently arrange for another Inspection and Report in accordance with AS4349.3 to be carried out prior to exchange, or prior to the expiration of any 'Cooling off Period', and prior to settlement.

(b) If the Report indicated the presence of Termites, termite damage or recommends any treatments or other Inspections and Reports, you should obtain copies of the treatment proposal, any certificates of treatments carried out, details of all repairs including copies of quotations, invoices, and any other Reports.

It is strongly recommended that you arrange for an Inspection and Report in accordance with AS 4349.3 to verify that the treatment has been successful and carried out in accordance with AS 3660.2 and a further building Inspection in accordance with AS 4349.1.

(c) If you fail to procure a further Inspection and report as recommended in (a) and (b), or fail to obtain copies of the treatment proposal, certificates of treatment carried out, details of all repairs including copies of quotations, invoices and any other reports as recommended in (b) above, then it will be deemed that you have decided not to have a further Inspection and report carried out, or to obtain copies of certificates of treatments carried out, details of all repairs including copies of quotations, invoices and any other reports.

It will be deemed that you have relied upon your own enquiries and the report, knowing the possible consequences and that the condition of the property, as stated in the report, may have changed.

(d) The person carrying out the Inspection and the company, partnership or sole trader that employs that person will have no liability to you for any damage or loss you may suffer as a result of your entering the contract to purchase the property or in connection with completing the purchase of the property as a result of your failure to heed the advice given in (a) and (b) and the warning contained in (c) above, and may use such failure in defense of any claim that you may later make against any of them.

Compliance Report



COMPLIANCE REPORT

This is a Compliance Report regarding any unapproved structures or alterations. ACT Property Inspections have accessed the attached Building File from ACT Planning and Land Authority (ACTPLA) and hold no responsibility for any inaccuracies in the Building File supplied by ACTPLA. The Compliance report is based solely upon the information available from the Building File which does not contain information regarding Plumbing or Electrical work that has taken place since the original construction. Information regarding the Plumbing and Electrical is available upon application from ACTPLA. Since we are not Plumbers or Electricians, we are unable to comment on those works. If structures have been noted as requiring approval, a Certifier should be engaged to assess if the structure will comply with the relevant ACT legislation. Owners must be aware that unapproved structures may not comply and may require significant repair, design change or possible removal.

Property Address: 97 Fitchett Street, Garran ACT 2605
Block & Section: Block 29 Section 8 GARRAN
Inspection Date: Thursday, May 7th 2026

APPROVAL STATUS

Description	Plan number	Certificate of occupancy date	Approval status
Brick Residence	13330+/A+/B+/C+/D	05/07/1972	Approved.
Brick Addition to Residence	13330/E	27/09/1977	Approved.
Fibreglass Swimming Pool	13330/F	20/01/1980	Approved. Note: The pool fence has been altered. Further approval is required. Please see below.
Retaining wall and external change room	13330/G	-	A Certificate of Occupancy has not been awarded for this work. Final approval is still required.
Brick Two Storey Extension	13330/H	-	A Certificate of Occupancy has not been awarded for this work. Final approval is still required.
Superseded	13330/A	-	Superseded.
Amendments and Extensions	13330/J	-	A Certificate of Occupancy has not been awarded for this work. Final approval is still required.
Amendments to Proposed Additions	13330/K	-	A Certificate of Occupancy has not been awarded for this work. Final approval is still required.
Pergola	13330/L	-	A Certificate of Occupancy has not been awarded for this work. Final approval is still required.
Installation of Solid Fuel Appliance	B20215391/A	19/07/2022	Approved.
Pool Fence (previously approved under plan 13330/F)	-	-	The pool safety barrier fence no longer matches the approved plans and requires certification prior to a Certificate of Occupancy and Use being issued.

Description	Plan number	Certificate of occupancy date	Approval status
Front stone retaining wall	-	-	This structure is unapproved as the wall is higher than 1.2m and has been constructed forward of the building line. Building and Development approval is required.
Left side metal structure	-	-	This structure has been built inside a service easement. Should access be required to the easement by the service provider, this structure may need to be removed at the owner's expense.
Rear timber storage shed	-	-	This structure is exempt from approval.

APPROVAL STATUS - CONTINUED

Note: As a Pool/Spa has been installed it will require one of the following: Exemption Certificate, Compliance Certificate, Swimming Pool Disclosure Statement or Certificate of Occupancy for the pool/spa and safety barrier that is not older than 5 years.

Addendum 11/05/2026: We have been advised that an approval for Additions and Alterations to the residence, is in progress

ACTPLA COMMENTS

- No Certificate of Occupancy issued for 13330/G – Application, Permits & Footings Inspections only
- No Certificate of Occupancy for plan 13330/H & Amendments/J+/K – Applications, Permits only & Pre-sheet Inspection only
- No Certificate of Occupancy for 13330/L – Application, Permit & Final Inspection only
- Page 3/3 missing from Plan B20215391/A

SURVEY REPORT

Survey Report completed by	Date Survey report was completed	Comments
K. F. Michniewicz	Wednesday, 21 August 1968	There are no apparent encroachments upon this land or by this property on adjoining lands or street.

Conveyancing File



CONVEYANCING BUILDING FILE INDEX

SUBURB: **GARRAN** SECTION: **8** BLOCK: **29** UNIT: **N/A** EX GOV: **NO**

COU ISSUED Y/N	PLAN NUMBER	FOLIO NO.	DESCRIPTION OF WORK	AMEND	DETAILS	PERMIT NUMBER	COU PLAN NO. & DATE
Y	13330	2	BRICK RESIDENCE				
		5				13330	
Y	13330/A	6		Y			
Y	13330/B	7		Y			
Y	13330/C	10		Y			
Y	13330/D	12		Y			
		67					13330+/A/B/C/D 05/07/1972
Y	13330/E	71	BRICK ADDITION TO RESIDENCE				
		74				13330/E	
		94					13330/E 27/09/1977
Y	13330/F	96	FIBREGLASS SWIMMING POOL				
		98				13330/F	
		104					13330/F 20/01/1980
N	13330/G	105	BRICK TOILET & SHOWER				
		108				13330/G	
		110	FOOTINGS INSPECTION – 05/11/1980				
		112	FOOTINGS INSPECTION – 14/11/1980				
N	13330/H	113	BRICK VENEER TWO STOREY EXTENSION				
		115				13330/H	
NA	13330/I	118	SUPERSEDED				
N	13330/J	120	AMENDMENTS AND EXTENSIONS	Y			
N	13330/K	123	AMENDMENTS TO PROPOSED ADDITIONS	Y			
		128				13330/H/K	
		131	(COMPLETION)			13330/G	
		-	PRESHEET INSPECTION – 18/05/1981				

N	13330/L	-	PERGOLA				
		-				13330/L	
		-	FINAL INSPECTIONM – 08/01/1985				
Y	B20215391/A	-	INSTALLATION OF SOLID FUEL APPLIANCE			B20215391/A	
		-					B20215391/A 19/07/2022

For any incomplete approvals please email acbuildingconveyance@act.gov.au for further information on how to complete.

Drainage Plan Number: 11115

Survey: Y (1)

Comments: NO COU ISSUED FOR 13330/G – APPLICATION, PERMITS & FOOTINGS INSPECTIONS ONLY

NO COU ISSUED FOR PLAN 13330/H & AMENDMENTS /J+/K – APPLICATIONS, PERMITS ONLY & PRESHEET INSPECTION ONLY

NO COU ISSUED FOR 13330/L – APPLICATION, PERMIT & FINAL INSPECTION ONLY

PAGE 3/3 MISSING FROM PLAN B20215391/A

CONVEYANCING PART 2

No information is provided in respect of electrical, drainage or sewer matters and or to the location of overhead power lines or underground cables in relation to the building.

	<u>Yes</u>	<u>No</u>
1. (a) Is this a government or ex government house?	<input type="checkbox"/>	<input checked="" type="checkbox"/>
(b) If yes, is there a building file with approvals on it?	<input type="checkbox"/>	<input type="checkbox"/>
2. Is there any record of incomplete building work on the building file? If yes - file copies attached	<input checked="" type="checkbox"/>	<input type="checkbox"/>
3. Are there any records on the building file of current (within 5 years) housing Indemnity insurance policies for building work? If yes - file copies attached	<input type="checkbox"/>	<input checked="" type="checkbox"/>
4. Are there any records on the building file showing building applications still being processed? (Current within 3 years) If yes - file copies attached	<input type="checkbox"/>	<input checked="" type="checkbox"/>
5. Are there any records on the building file in relation to loose-fill asbestos insulation?	<input type="checkbox"/>	<input checked="" type="checkbox"/>

If available, copies of the following documents are provided:

• Certificate/s of Occupancy and Use	<input checked="" type="checkbox"/>	<input type="checkbox"/>
• Survey Certificates	<input checked="" type="checkbox"/>	<input type="checkbox"/>
• Unit Plan/Unit Entitlements (if property is unit titled)	<input type="checkbox"/>	<input checked="" type="checkbox"/>
• Approved Building Plans	<input checked="" type="checkbox"/>	<input type="checkbox"/>
• Ex- government Building Plans*	<input type="checkbox"/>	<input checked="" type="checkbox"/>

If requested:

• Drainage Plan(s)	<input checked="" type="checkbox"/>	<input type="checkbox"/>
--------------------	-------------------------------------	--------------------------

ASBESTOS

The ACT Government is not able to guarantee the accuracy of the information in this report.

You should make your own enquiries and obtain reports (from a licensed Asbestos Assessor) in relation to the presence of loose fill asbestos insulation (and other forms of asbestos) on the premises. For more information go to the Asbestos Awareness Website –

www.asbestos.act.gov.au

Please note: Development Approval plans will not be included in this report (We do not receive Development Approval Plans unless they are part of a Building Approval in which case they become Building Approval Plans), if development approval was granted you can request copies of the Development Approval plans from ACEPDcustomerservices@act.gov.au.

Please Note: Building approvals that have been generated via eDevelopment will be issued with a project number prefixed by the letter B. Initial building approval documentation will be identified with project number B20XXXX only but will be referenced as B20XXXX/A on the Certificate of Occupancy and Use. Any amendments to the original approval will be issued with the project number and an alphanumeric digit. The first amendment will be identified as B20XXXX/B, the second amendment B20XXXX/C etc. Not all eDevelopment plans will be stamped with the plan number.

*Ex Government plans: Plans are typical and not specific to each residence. There may be slight changes to the layout or window locations that were not required to be approved.

Search officer comments (if any?)

Search officer initials: Ashleigh

Cost of application: \$ 144.79

Date completed:

09/02/2026

CERTIFICATE AS TO FITNESS FOR OCCUPANCY AND USE

Plan Number(s) 13330 & 13330/A1B/C/D.	Permit Holder A. A. SMITH.
	Lessee A. I. KENNER.

I certify that a

BRICK RESIDENCE

on Block 29 of Section 8 at GARRAN.

is fit for occupancy and use.

5/7/72

S. P. White
Deputy Proper Authority

198317/1....

S/S

PROPOSED BRICK RESIDENCE AT
 BLOCK 29, SECTION 8, GARRAN,
 FOR:
 MR. & MRS. A.I. KENNER.

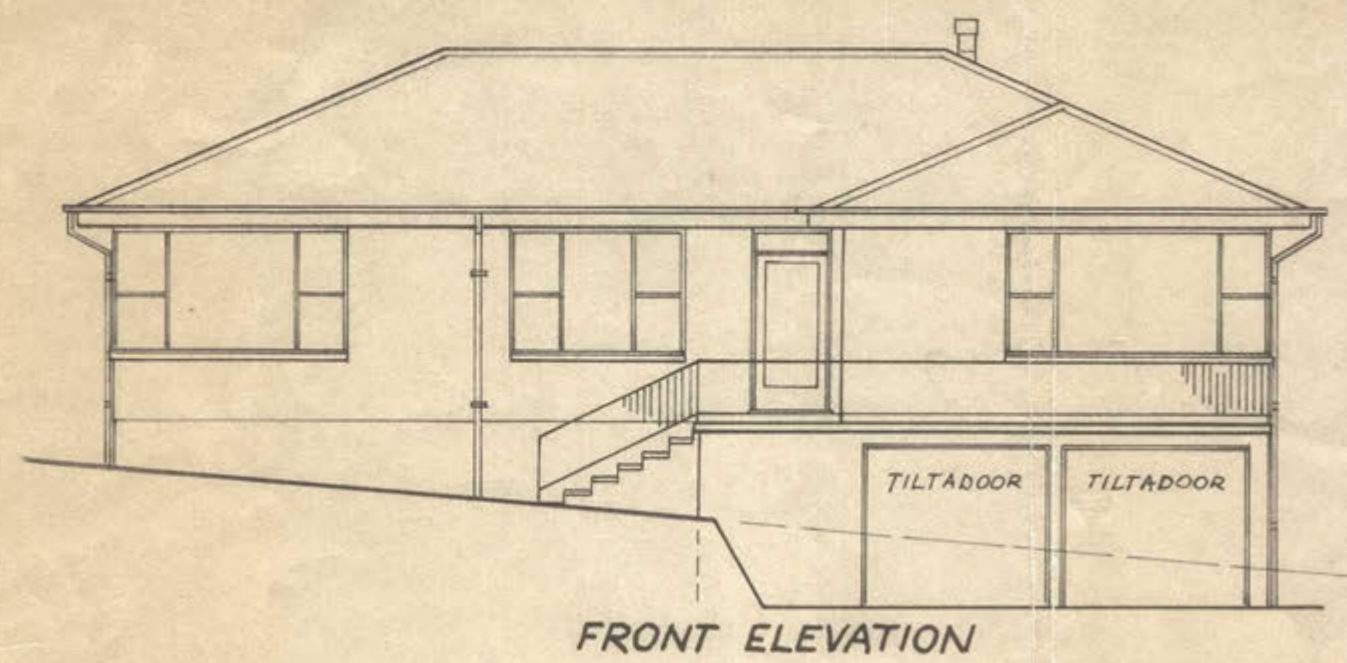

FRONT ELEVATION

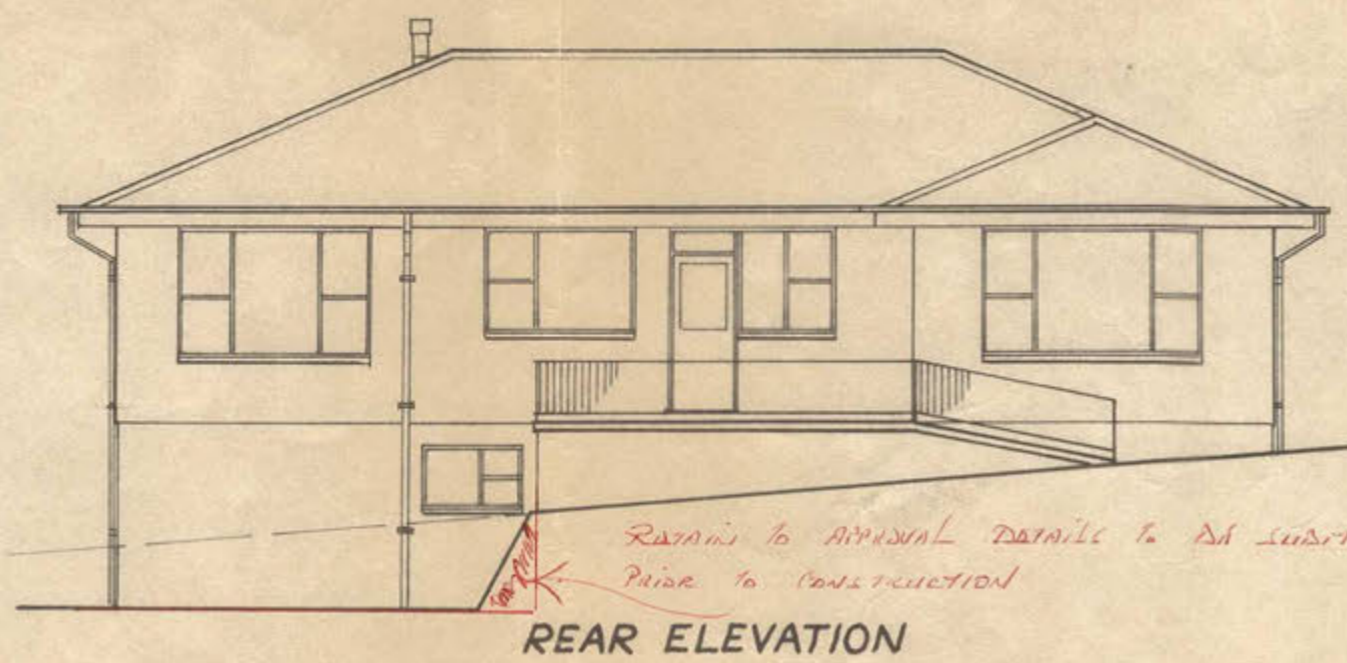

REAR ELEVATION

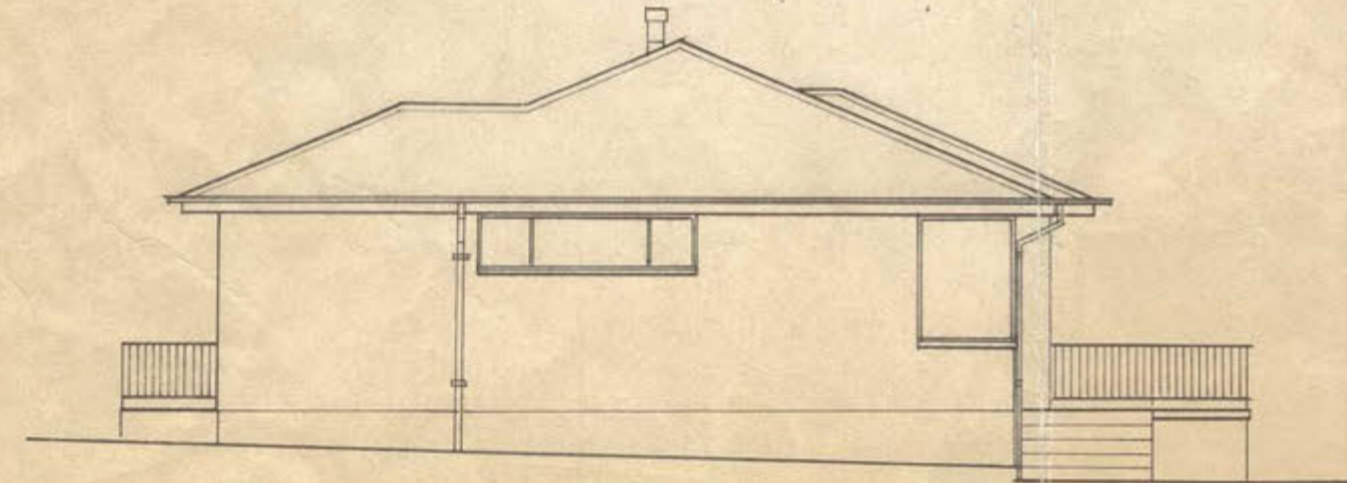

SIDE ELEVATION

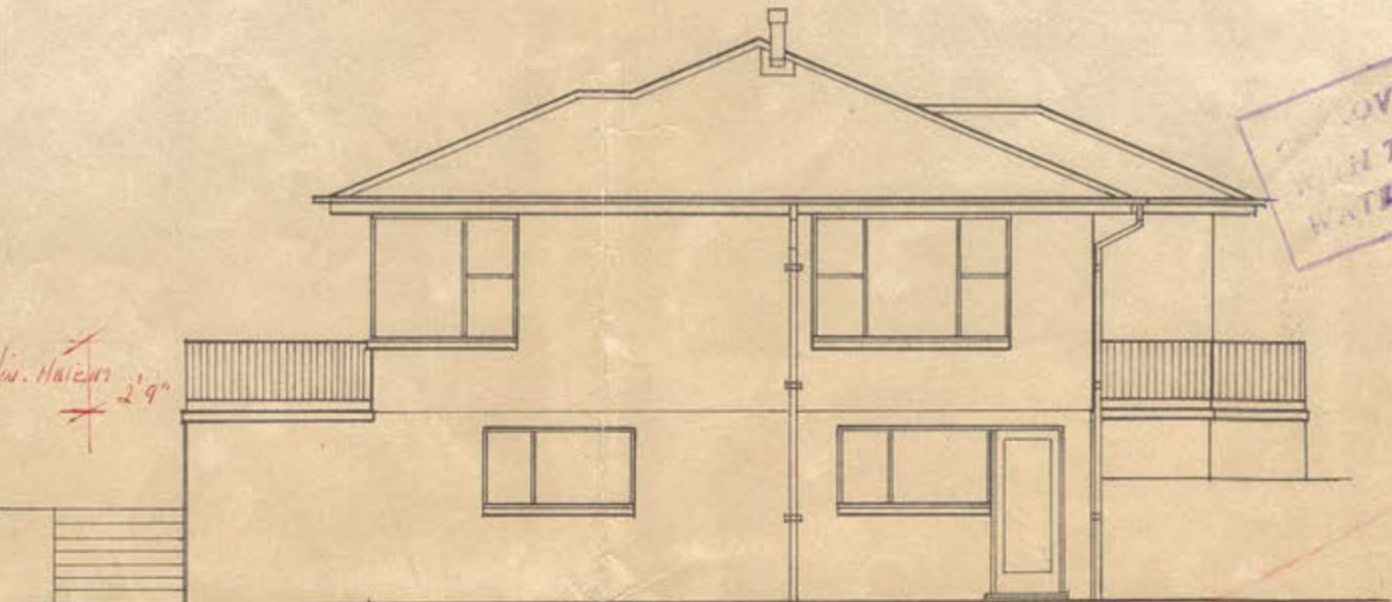

SIDE ELEVATION

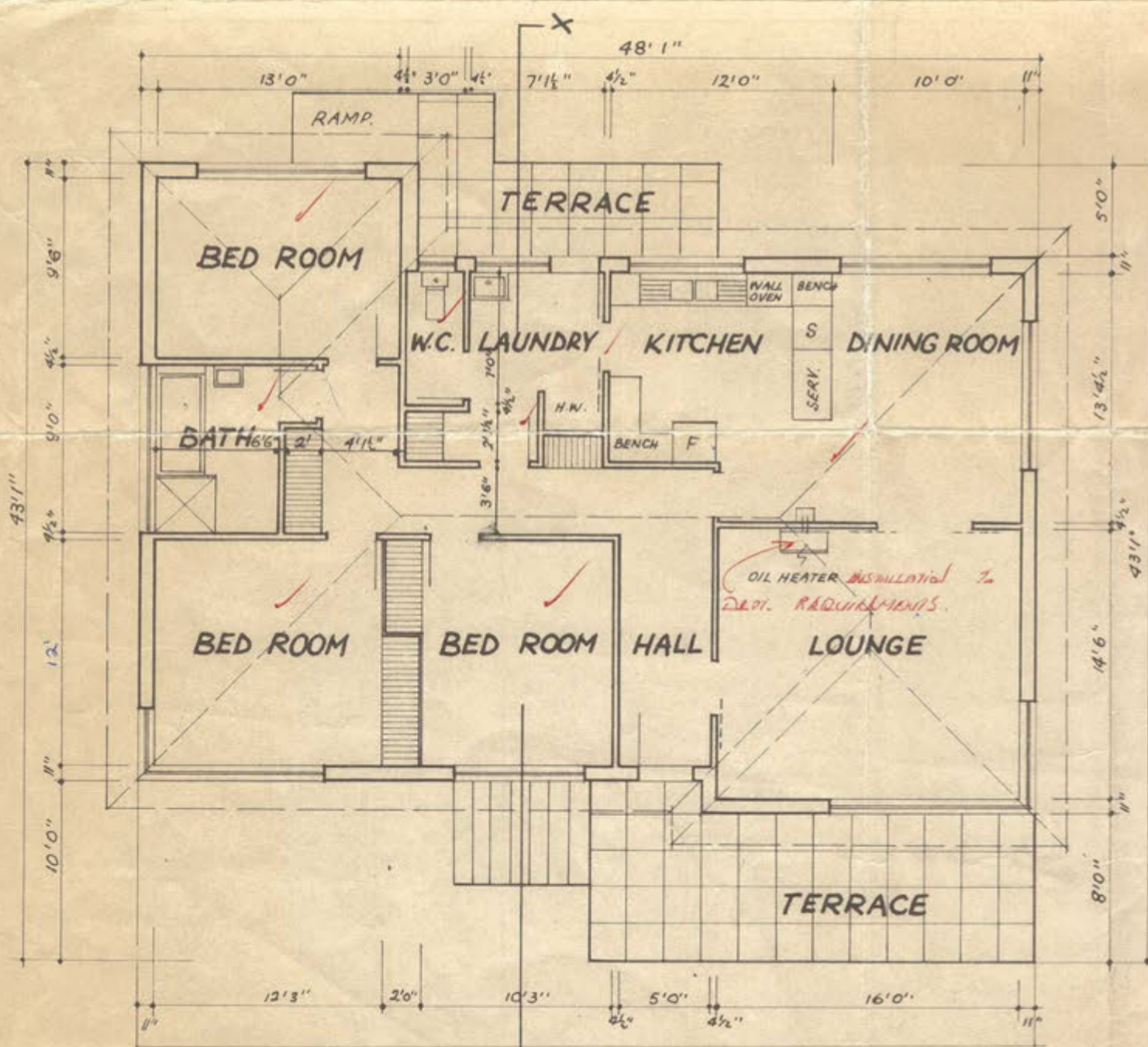

GROUND FLOOR PLAN - SCALE 1/8" = 1'0"

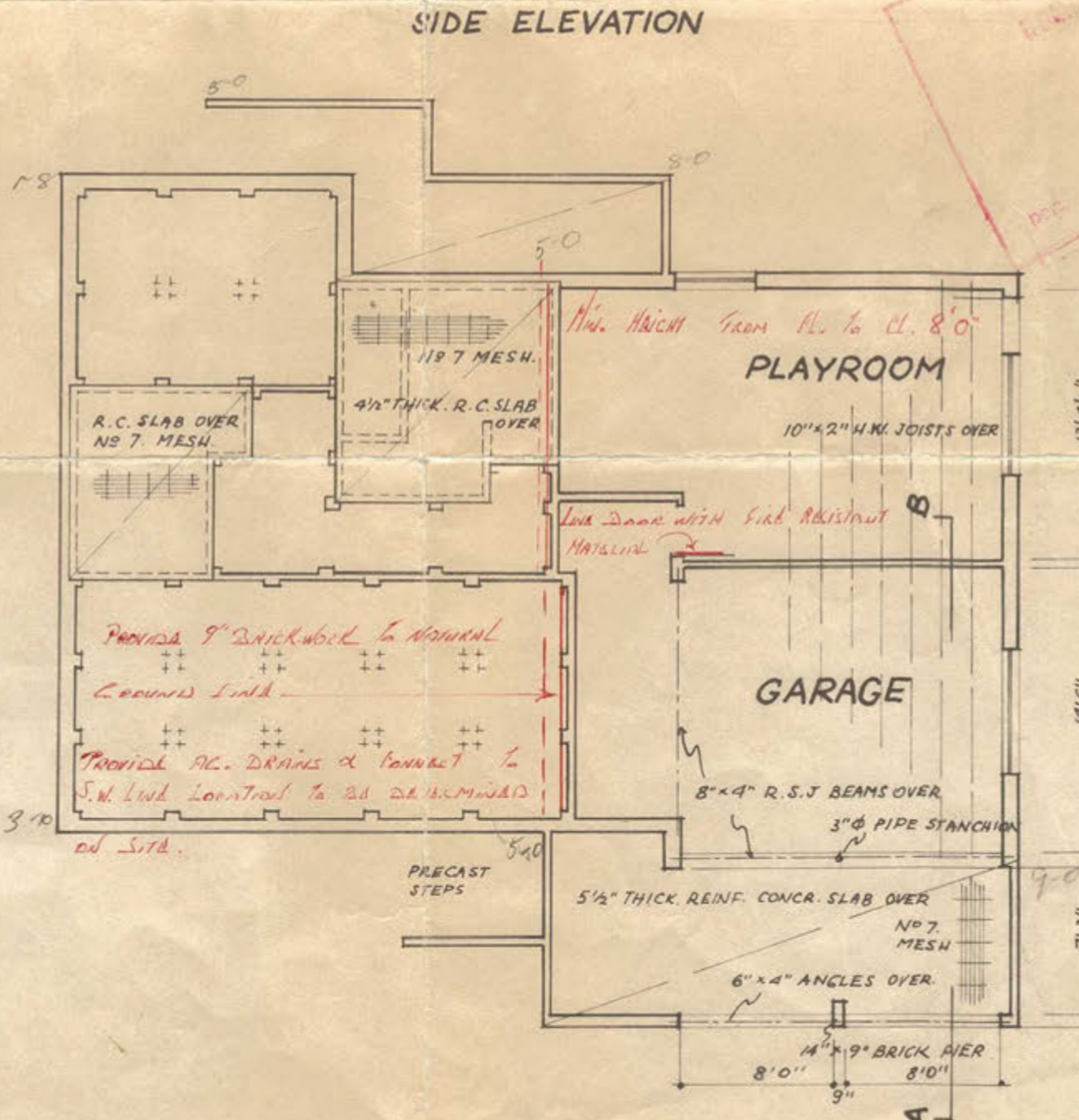

BASEMENT PLAN

APPROVED SUBJECT TO COMPLIANCE
 WITH THE CANBERRA SEWERAGE AND
 WATER SUPPLY REGULATIONS.

SITE PLAN
 SCALE 1" = 40'

BUILDING TO BE CONSTRUCTED IN
 ACCORDANCE WITH THE CANBERRA
 BUILDING REGULATIONS AND S.A.
 CODES OR AS DIRECTED

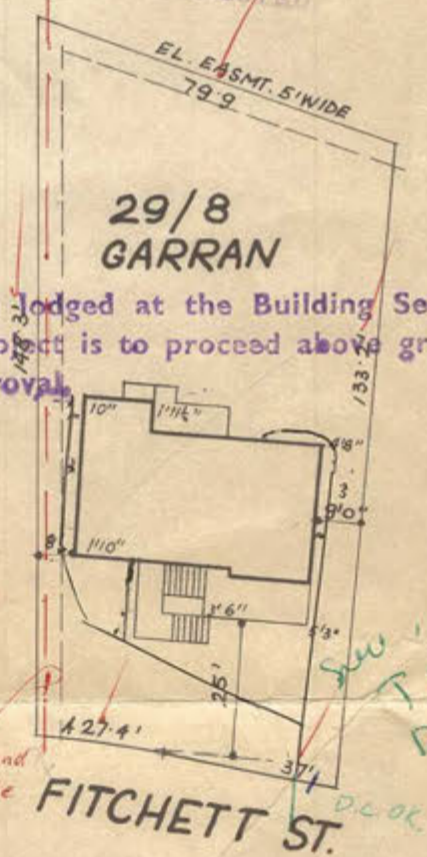

A check survey is to be lodged at the Building Section
 and no work on this project is to proceed above ground
 level without prior approval.

Continued

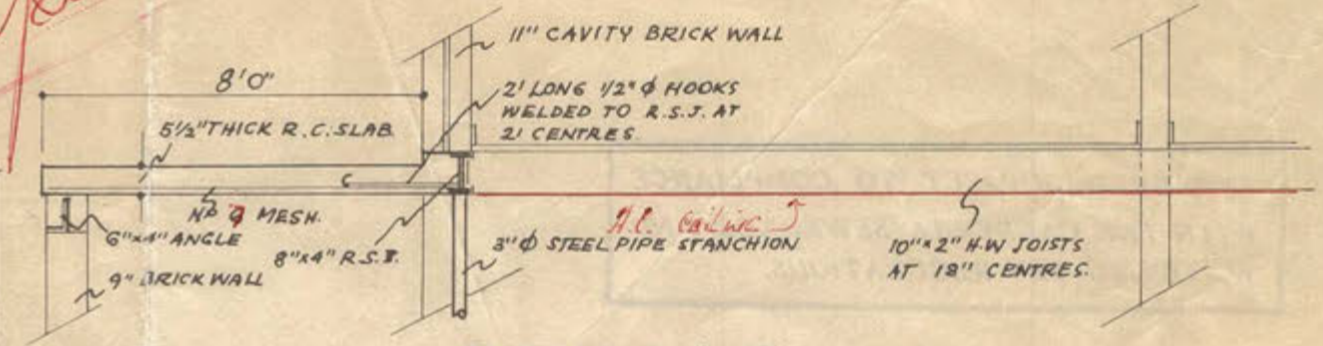

SECTION A-B

TILED ROOF, 22 1/2° PITCH.

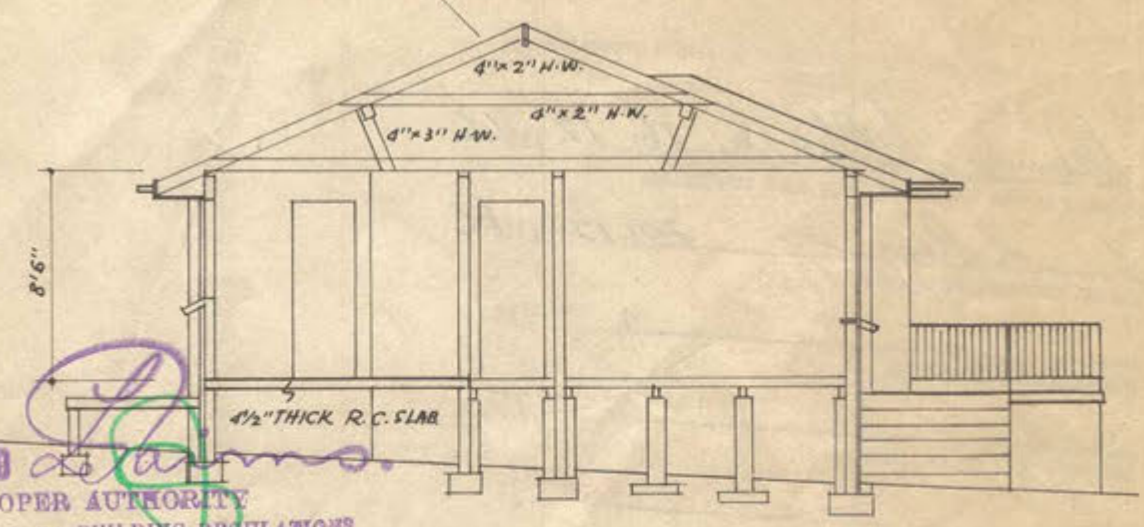

SECTION X-X

APPROVED
 PROPER AUTHORITY
 CANBERRA BUILDING REGULATIONS
 6 JAN 1967

13330R
S.B.

PROPOSED RETAINING WALLS AT
BLOCK 29, SECTION 8, GARRAN,
FOR:

MR. & MRS. A. I. KENNER

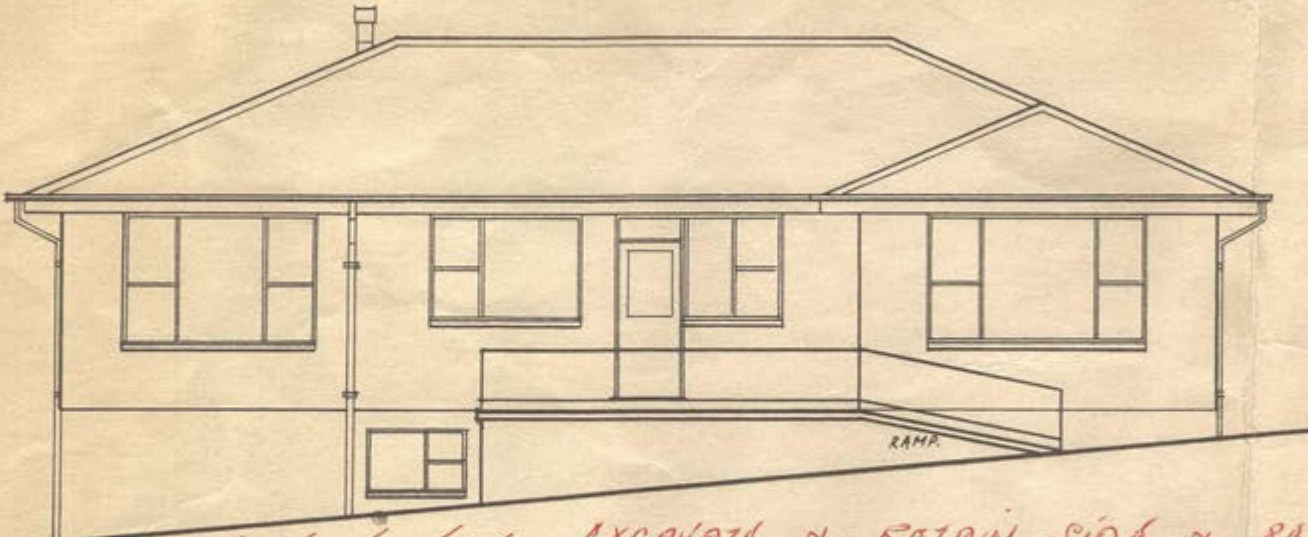

EXCAVATE & RETAIN SIDE & REAR
AS PER DETAIL.

REAR ELEVATION

Handwritten notes in red ink: '... WILL BE ... TO BE ...'

DEPARTMENT OF WORKS
DEPARTMENTAL RECORDS INDICATE THAT PORTION OF THE EXISTING SANITARY DRAINAGE SERVICE WILL BE UNDER THE PROPOSED STRUCTURE. AN APPROVED SANITARY DRAINAGE PLAN SHOWING WHAT ACTION IS TO BE TAKEN TO PROTECT OR RELOCATE DRAINS UNDER THE PROPOSED STRUCTURE, AND ANY OTHER ACTIONS OR ADDITIONS TO SEWER DRAINAGE NECESSARY MUST BE OBTAINED AND FORM PART OF THE WORK CONNECTED WITH THIS PROJECT.

SECTION OF RETAINING WALL

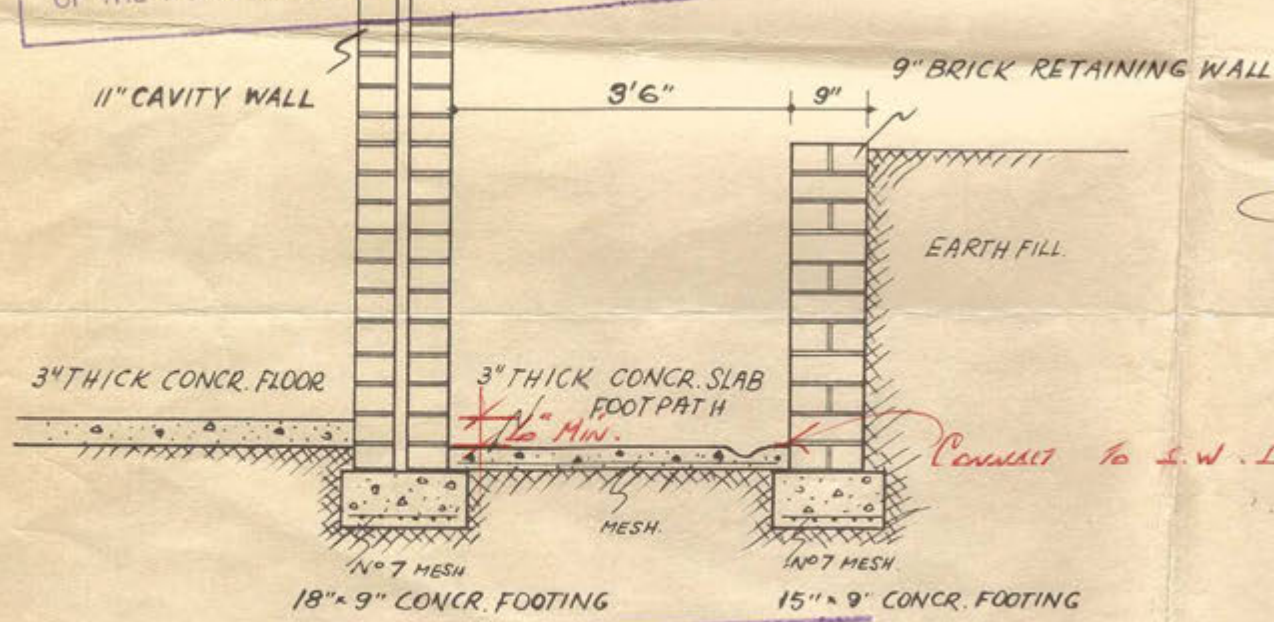

APPROVED SUBJECT TO COMPLIANCE WITH THE CANBERRA SEWERAGE AND WATER SUPPLY REGULATIONS.

T. J. Brooks (Devel...)
For and on behalf of...

SITE PLAN
SCALE 1"=40'

3/3/67

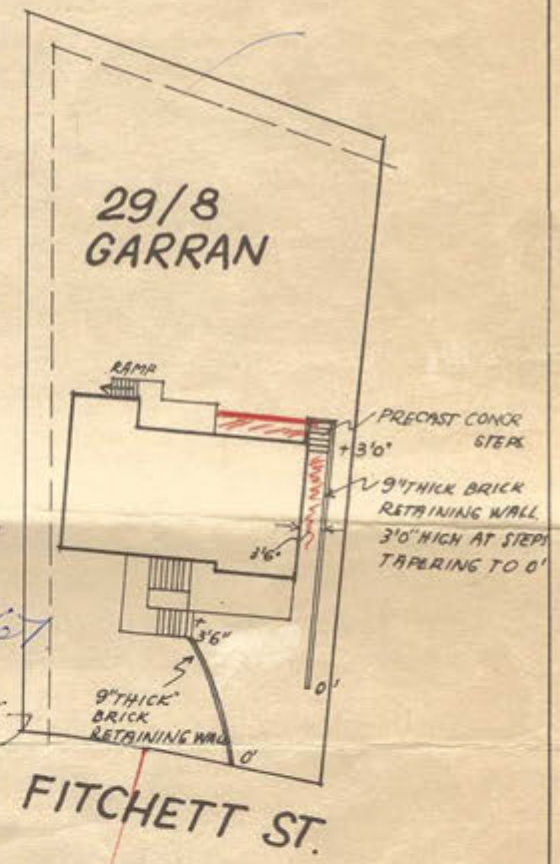

ENGINEER FOR WATER SUPPLY AND SEWERAGE 13/3/1967
CHIEF ELECTRICAL ENGINEER 8/3/1967
STRUCTURAL ENGINEER 1/19
ARCHITECT AND BUILDER APPROVED 1/3/1967
SENIOR TECHNICAL OFFICER BUILDING REGULATIONS
23 MAR 1967

No higher than level of backfill.

ANDS BRANCH DEPT. OF PUBLIC WORKS
 CANBERRA BUILDING REGULATIONS AND BY-LAWS
 PLAN No. B/S **13330/B**

AMENDED PLAN OF BASEMENT & FUTURE FLAT

29/8 GARRAN
 MR & MRS. A. I. KENNER.

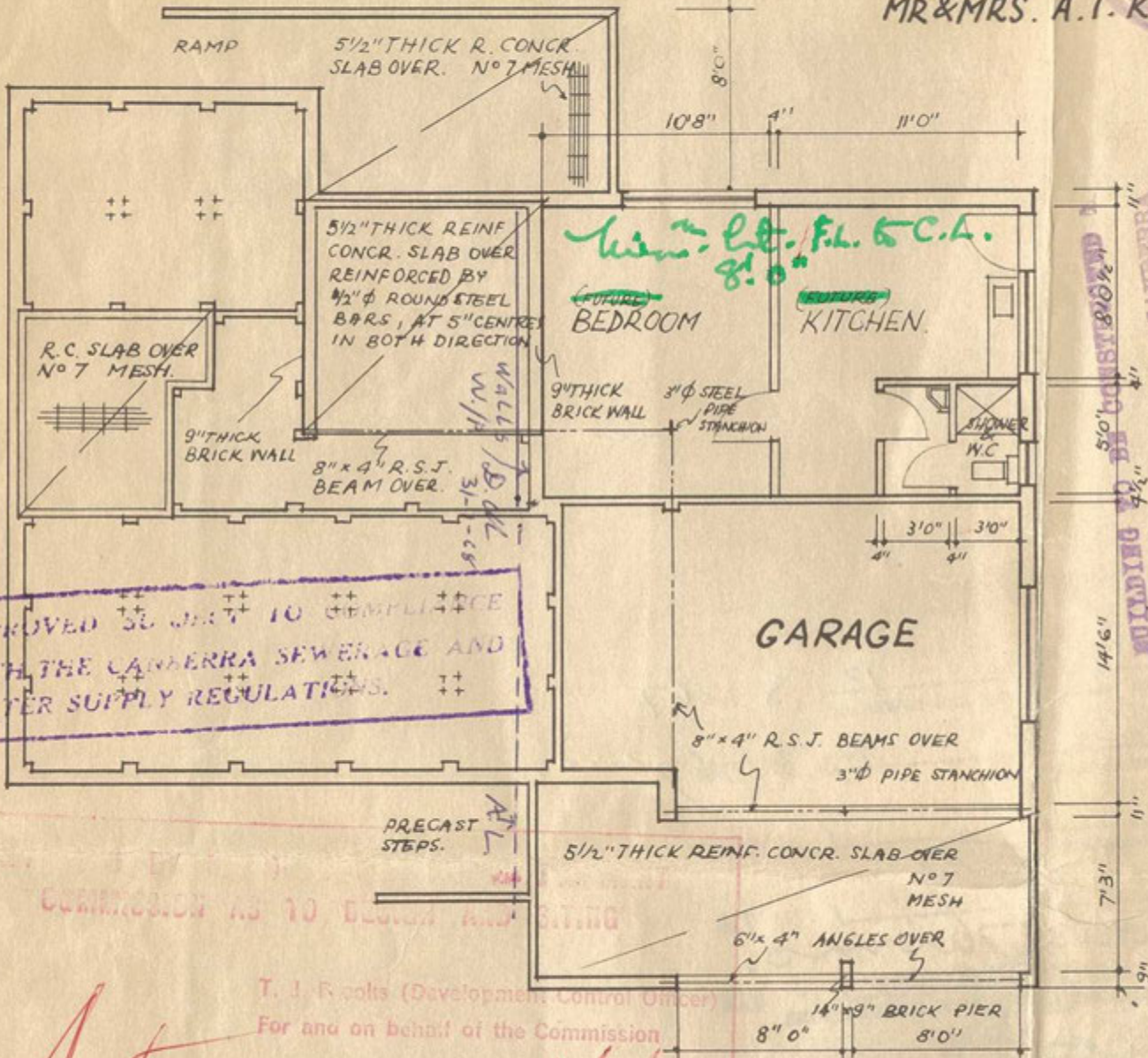

APPROVED SUBJECT TO COMPLIANCE WITH THE CANBERRA SEWERAGE AND WATER SUPPLY REGULATIONS.

BUILDING TO BE CONSTRUCTED IN ACCORDANCE WITH THE CANBERRA BUILDING REGULATIONS AND BY-LAWS OR AS DIRECTED

per: *[Signature]* Date: *13/3/67*
 T. J. Rodds (Development Control Officer)
 For and on behalf of the Commission

AMENDED PLAN OF BASEMENT AT 29/8 GARRAN, FOR: MR & MRS.

A.I. KENNER

PLEASE NOTE:

- ① 2 ONLY PIERS TO BE OMITTED, DUE TO ROCKY GROUND & 2 ONLY ~~4"x3" ANGLES TO SUPPORT 6"x3" H.W. BEARERS.~~ (2x) TO BE FIXED IN POSITION INDICATED.
- ② ONE ONLY 12' WIDE TILT DOOR TO REPLACE DOUBLE DOORS.
- ③ OMIT CENTRAL PIPE SUPPORT & REPLACE 8"x4" R.S.J. WITH 10"x4 1/2" R.S.J. BEAM.
- ④ OMIT DIVIDING WALLS AND THE WHOLE SPACE TO BECOME PLAYROOM.

LANDS BRANCH DEPT. OF THE INTERIOR
 CANBERRA BUILDING REGULATIONS
 PLAN No. B/S. **13330/c**

BUILDING TO BE CONSTRUCTED IN
 ACCORDANCE WITH THE CANBERRA
 BUILDING REGULATIONS AND S.A.A.
 CODES OR AS DIRECTED.

Approval GRANTED as to External Design
 and Siting
 Date **21/12/65**
 Delegate
**NATIONAL CAPITAL
 DEVELOPMENT COMMISSION**

RECEIVED
 14 MAR 1966
 DEPT. OF THE INTERIOR
 CANBERRA REGION

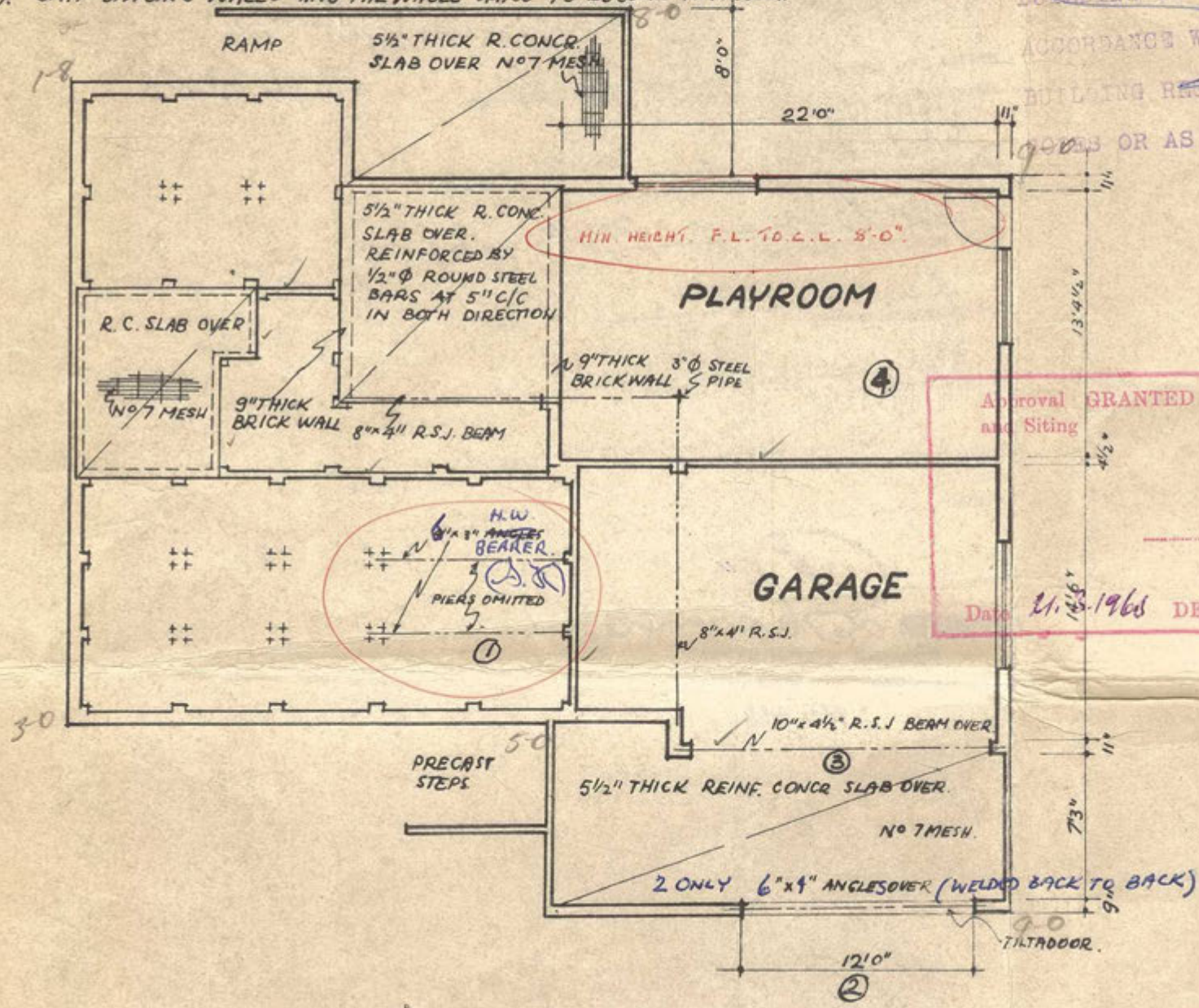

51/2

PROPOSED ALTERATION TO RETAINING WALLS AND FOOTPATH WIDTH.

BLOCK 29. SECTION 8. GARRAN. FOR MR + MRS. A.I. KENNER.

RECEIVED AND RECOMMENDED FOR APPROVAL.

+ W. J. Shillaber 6/8/68
 CIVIL ENGINEER
 FOR WATER SUPPLY AND SEWERAGE
W. J. Rowe 7/8/68
 CIVIL ENGINEER
A. J. Anderson 13/8/68 (See Mr. Upton's note 12.8.68)
 CIVIL ENGINEER
Shaughnessy Morris 3/9/68
 ARCHITECT AND VALUER
M. Upton 26/8/68
 SENIOR TECHNICAL OFFICER
 APPROVED: _____ 1/2/68



BUILDING TO BE CONSTRUCTED IN ACCORDANCE WITH THE CANBERRA BUILDING REGULATIONS AND S.A.A. CODES OR AS DIRECTED.

APPROVED [Signature]
 PROPER AUTHORITY
 UNDER CANBERRA BUILDING REGULATIONS
 3 SEP 1968

SECTION OF RETAINING WALL.

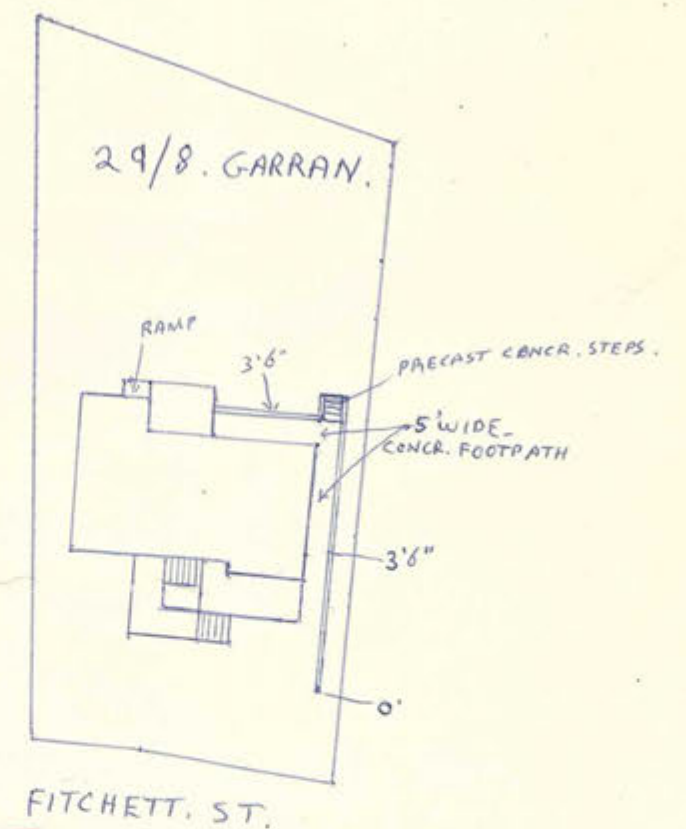
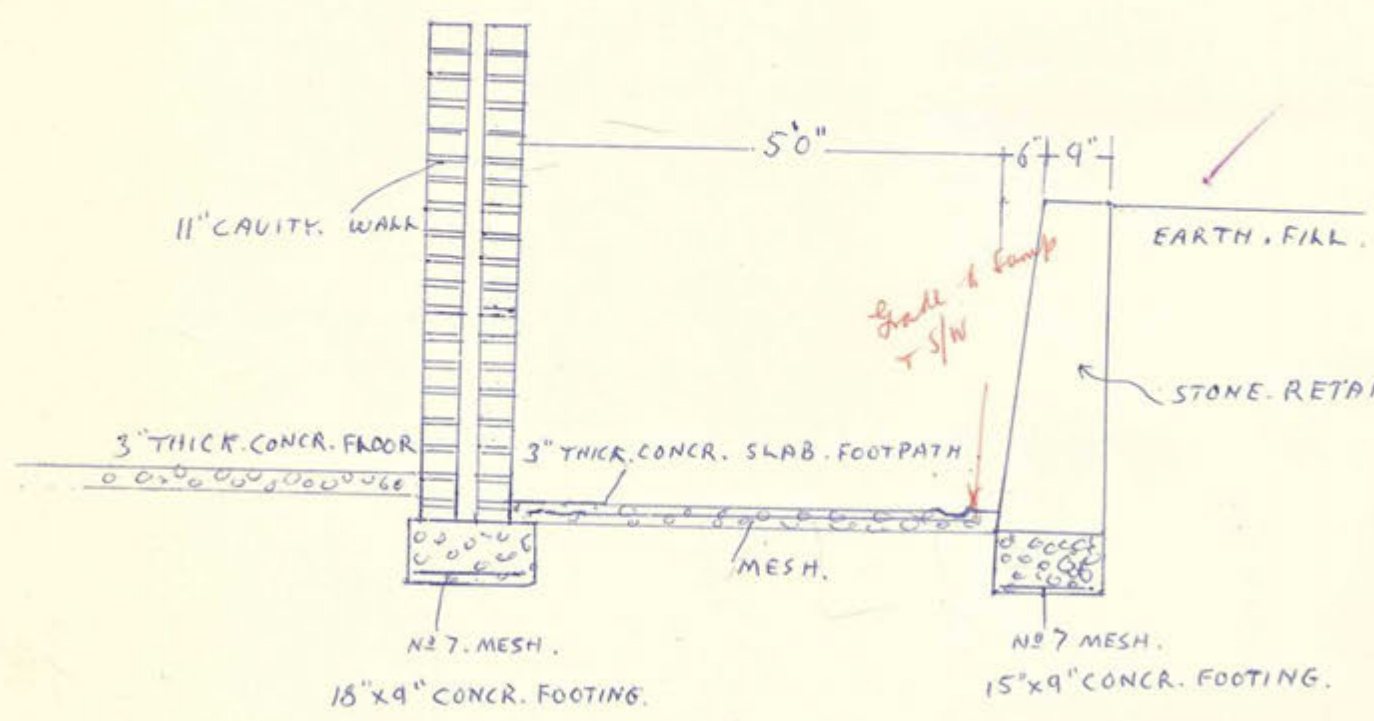

Approval GRANTED as to External Design and Siting
[Signature]
 Delegate
 NATIONAL CAPITAL DEVELOPMENT COMMISSION
 Date 15 JUL 1968

94

Department of the Capital Territory
Building Section

Australian Capital Territory
Building Ordinance 1972-74
(Part V)

CERTIFICATE OF FITNESS
(CLASS 7 AND X OCCUPANCY ONLY)

BL1/8(9/75)

It is hereby certified that the building consisting of Brick Addition to Residence

..... situated on

Block <u>29</u>	Section <u>8</u>	Division <u>Garran</u>
or situated at		

for which plans and specifications were approved and a Building Permit issued under the provisions of the Building Ordinance 1972, is fit for use and/or occupation.

Approved plan no.

13330/E

Type of construction*

Class of occupancy*

Number of storeys

Permit no.

25419/A

Name of permit holder

J Masgrave

*As defined in the Building Manual
A.C.T.

No

Page 49 of 99

1120

[Signature] 27/9/77
Deputy Building Controller

PLAN No. 13330/E
 Received Building Section
 16 SEP 1974 5/13
 Dept. of the Capital Territory

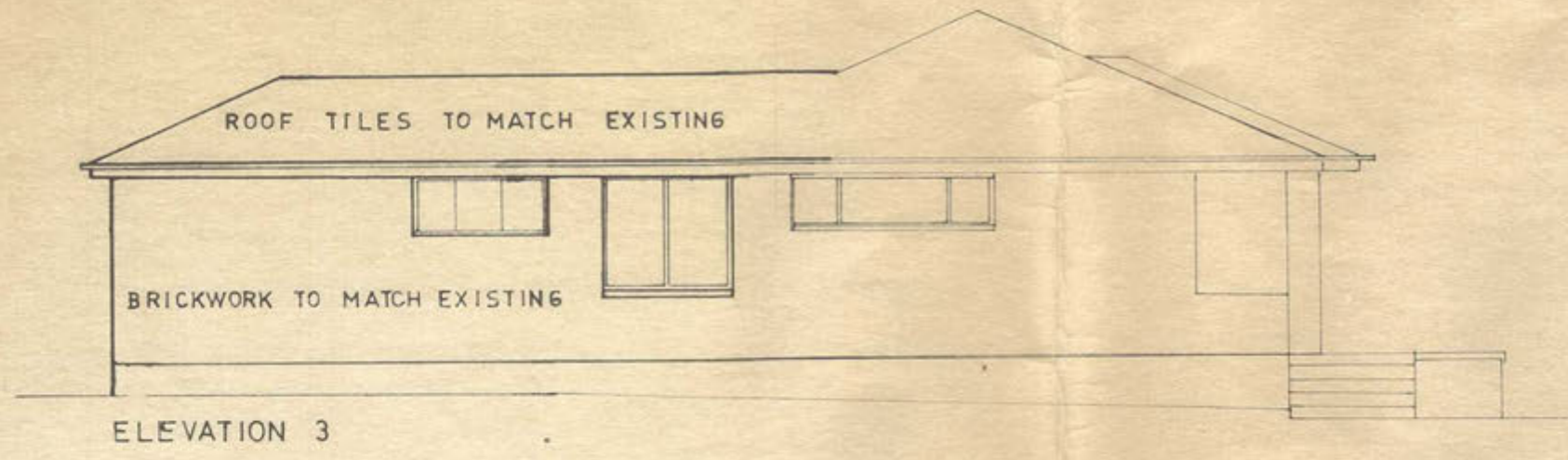

ELEVATION 3

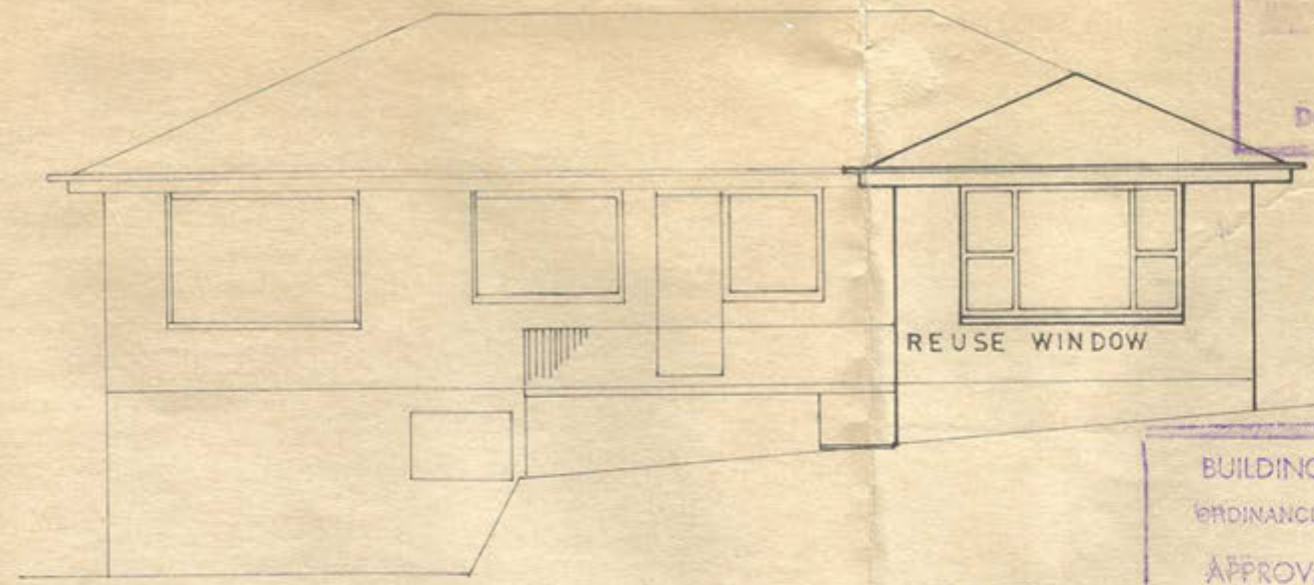

ELEVATION 1

BUILDINGS (DESIGN AND SITING)
 ORDINANCE 1934 AS AMENDED
 APPROVAL GRANTED 19 SEP 1974
 DELEGATE *J. G. ...*
 NATIONAL CAPITAL
 DEVELOPMENT COMMISSION

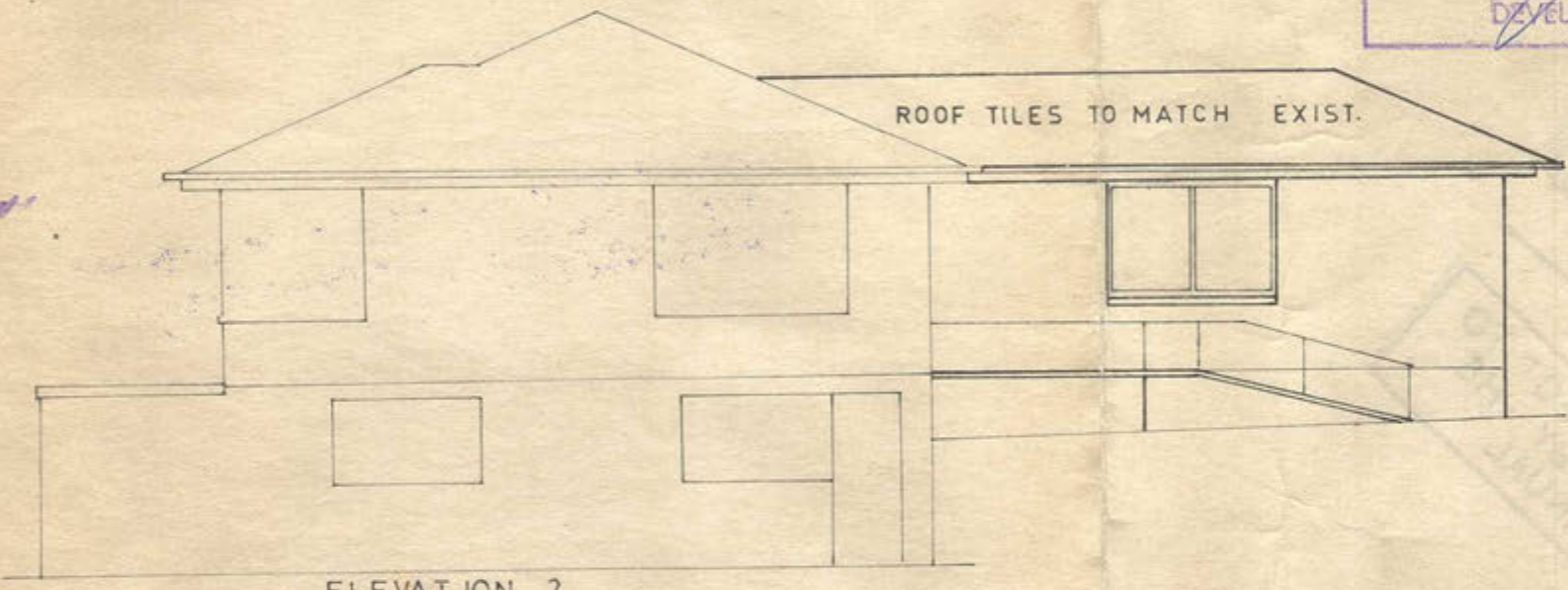

ELEVATION 2

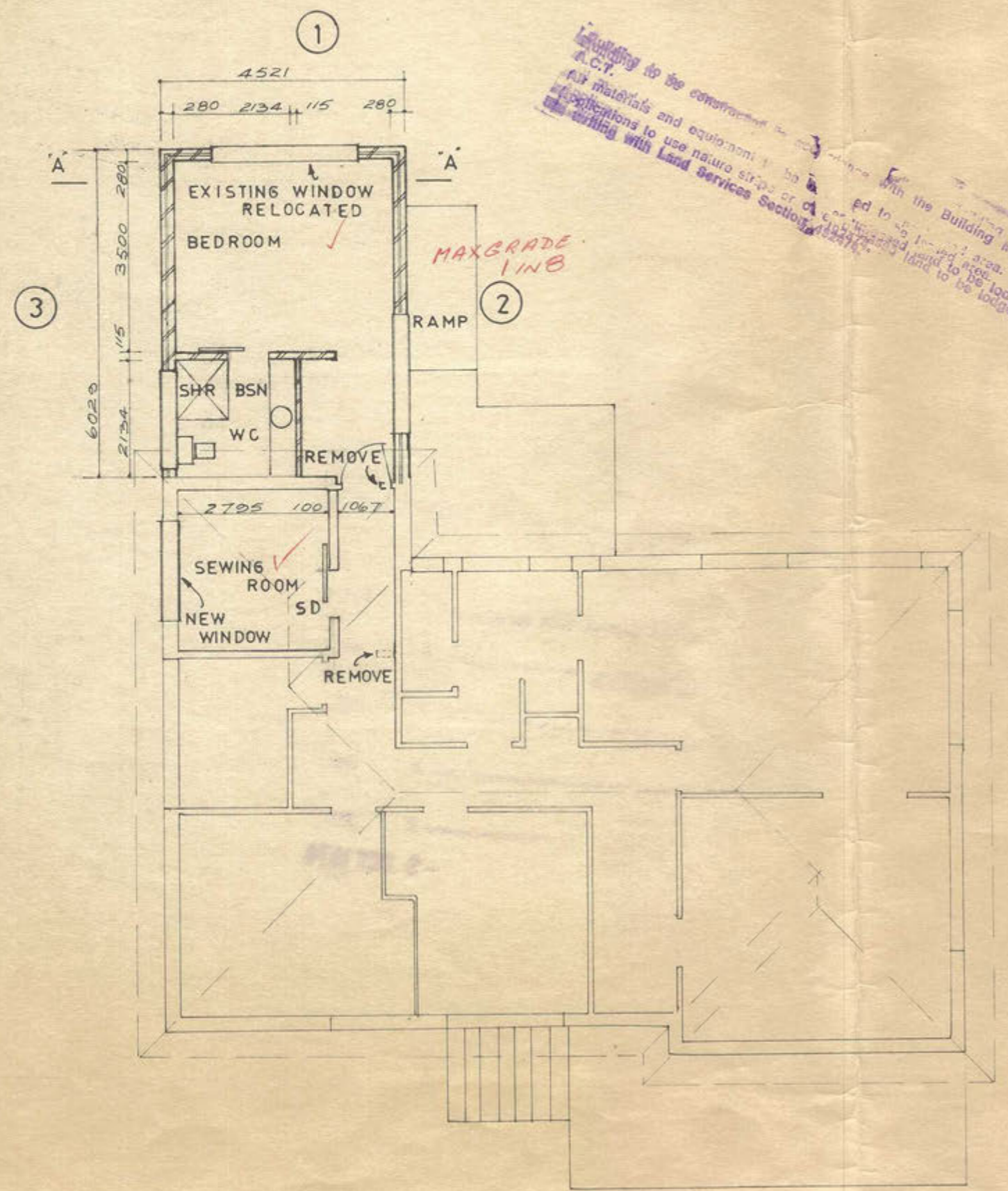

Calculating to the construction of the building with the Building Materials Act. All materials and equipment to be used in the construction of the building shall be of a quality and standard approved by the Building Materials Act. Applications to use natural stone or other materials shall be lodged in writing with Land Services Section.

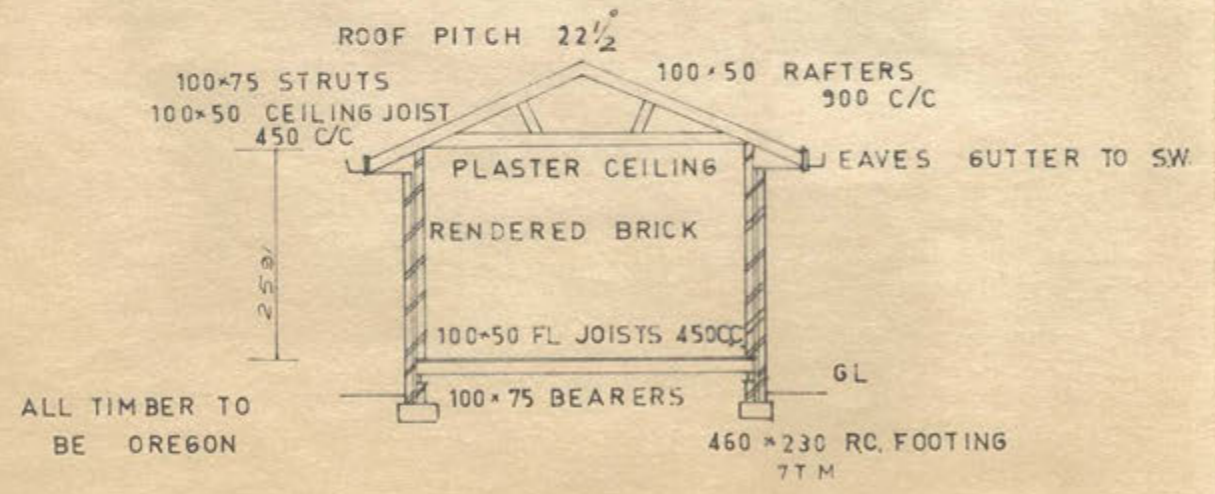

SECTION A-A

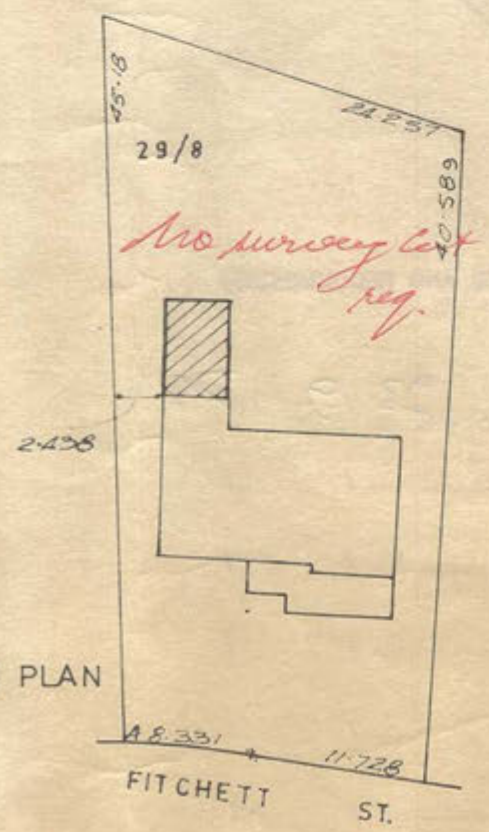

SITE PLAN

PROPOSED EXTENSIONS.
 FOR: MR & MRS. A.I. KENNER.
 BLOCK 29. SECTION 8. GARRAN.

SCALES. 1:100 1:500

AREA: 27.26 M² C'ST.

G. MOORE & N. SMITH
 J555.

PLANS/FILE No. 13330/E
Received Building Section
16 SEP 1974 3B
Dept. of the Capital Territory

SPECIFICATION

FOR: MR & MRS A. KENNER

BLOCK: 29 SECTION: B

SUBURB: GARRAN

GENERAL:

COMPLY WITH PLANS, DETAILS, SPECIFICATIONS AND SCHEDULES. IN THE EVENT OF DISCREPANCIES, FIGURED DIMENSION TAKE PRESEDENCE OVER THIS SPECIFICATION.

SUPPLY AND FIX TO THE TRUE EXTENT OF THE DRAWINGS AND SPECIFICATIONS ALSO THOSE ITEMS WHICH MAY NOT BE SHOWN ON THE DRAWINGS OR SPECIFICATIONS AND ARE OBVIOUSLY NECESSARY TO PROPERLY COMPLETE THE BUILDING.

COMPLY WITH THE REQUIREMENTS OF ANY RELEVANT CODE WHICH MAY BE ISSUED BY THE STANDARD ASSOCIATION OF AUSTRALIA.

1. CARPENTERS AND JOINERS:

1.1 TIMBERS

USE ONLY TIMBERS WHICH ARE THE BEST QUALITY OF THEIR RESPECTIVE KINDS, SOUND AND WELL-SEASONED, FREE FROM SAP, SHAKES, LARGE OR LOOSE KNOTS AND OTHER DEFECTS. MAKE USUAL ALLOWANCE FOR MATCHING AS ALL JOINERY TIMBERS ARE STANDARD STOCK MILLING. SAW SCATLINGS SQUARE TO THE SIZE SPECIFIED. MAKE JOINERY NOMINAL WITH FAIR TRADE ALLOWANCE FOR WORKING EXCEPTING WHERE FINISHED SIZE IS SPECIFIED.

1.2 GENERALLY

FRAME TRIM AND FINISH THE WHOLE OF THE CARPENTER'S AND JOINER'S WORK THROUGH OUT IN A WORKMANLIKE MANNER. PROVIDE AND FIX IRONMONGERY. GROVE, TONGUE, REBATE, HOUSE, BEAD, MITRE, SCRIBE AND TREAT AND DO ALL INCIDENTALS.

DO ALL CARPENTERS AND JOINERS WORK TO THE INTENSIONS OF THE DRAWINGS THOUGH NOT SPECIALLY MENTIONED. PRIME ALL JOINERY BEFORE LEAVING WORKSHOP AND WROT FINISH ALL TIMBER EXPOSED TO VIEW.

UFI POOLS

COOL POOLS OF CANBERRA

TECHNICAL DATA

"NERITUNE" 10.33 m. X 4.27 m.

DISC. REC. PERM.

SCALE OF PLAN & SECTIONS:

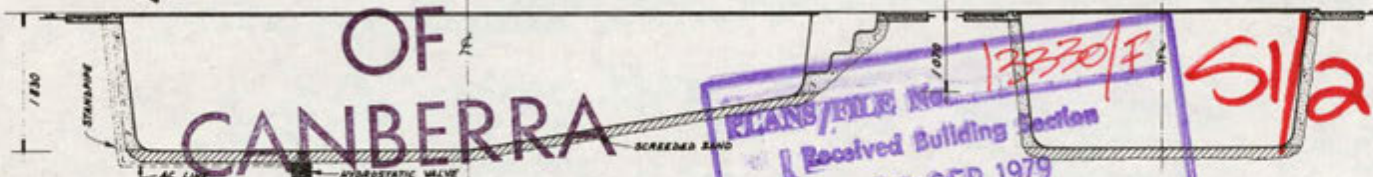
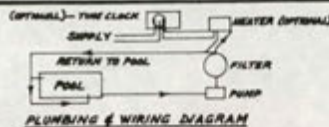
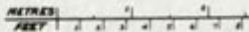

LONGITUDINAL SECTION

GROSS SECTION

PLANS/FILE No. 13330/F
 Received Building Section
 25 SEP 1979
 Dept. of the Capital Territory

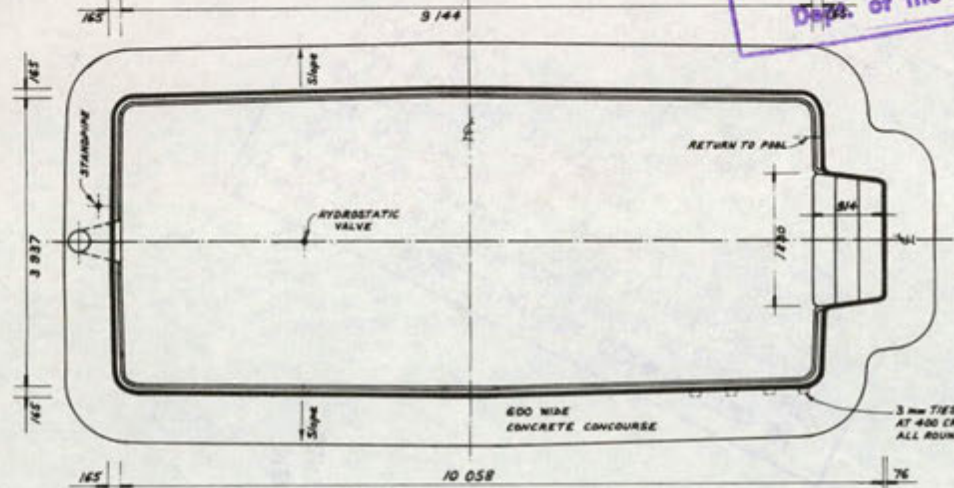

POOL PLAN

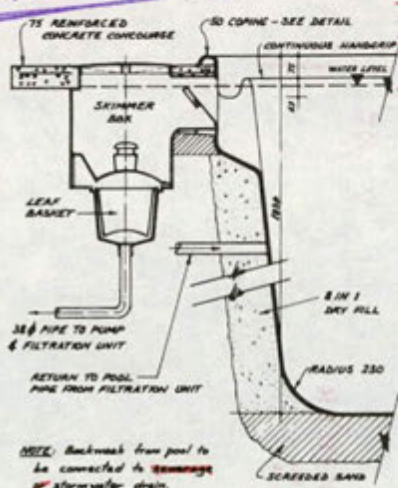

SKIMMER BOX DETAIL

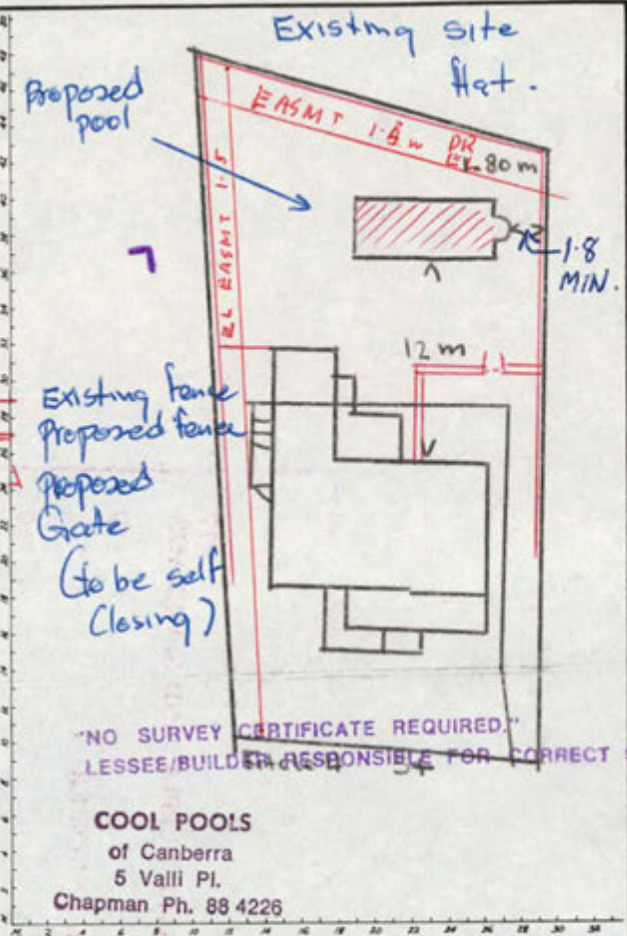

"NO SURVEY CERTIFICATE REQUIRED."
 LESSEE/BUILDER RESPONSIBLE FOR CORRECT SITING

COOL POOLS
 of Canberra
 5 Valli Pl.
 Chapman Ph. 88 4226

BLOCK PLAN 29/8

NOTE: THIS POOL-TYPE HAS BEEN EXAMINED AND REPORTED - ORIGINAL AVAILABLE ON REQUEST.
 E.J. PERRY M.E., M.I.C.E., M.A.S.T.E. CONSULTING ENGINEER.

SPECIFICATION:
GENERAL: THE BUILDER SHALL COMPLY WITH THE REQUIREMENTS OF ALL RELEVANT LOCAL GOVERNMENT AUTHORITIES.
EXCAVATION: EXCAVATE FOR POOL SHELL ALLOWING MIN. 150 mm. FOR THICKNESS OF SAND & GROUT. PLACE AND COMPACT SAND BASE TO PROVIDE AN EVEN SUPPORT FOR THE SHELL, AND WATER SAND AROUND SHELL WHERE INDICATED.
DRAINAGE: FOR ALL SWIMMING POOLS AN AGRICULTURAL DRAIN MUST BE BUILT FROM THE LOWEST POINT TO AN OUTLET OPEN TO THE ATMOSPHERE OR TO STANDPIPE. A HYDROSTATIC VALVE IS TO BE FITTED TO RELIEVE THE POOL OF HYDROSTATIC PRESSURE.
MANUFACTURE: TO MINIMUM REQUIREMENTS OF S.A.A. CODE 1838 - 1975.
CONCRETOR: CONCRETE SHALL HAVE MIN. COMPRESSIVE STRENGTH OF

15 MP. & SLUMP BUILD A CONCRETE THE BEAM 600 x 75 MIN. SIZE AROUND SHELL UNDER COPING. REINFORCE WITH FEZ FABRIC. FINISH CONCRETE AROUND POOL TO WOOD FLOAT SURFACE. CLEAN UP AREA AROUND POOL AND LEAVE AREA IN A TIDY CONDITION.
FILTER INSTALLATION: INSTALL A MODEL (SEE DETAIL) SKIMMER BOX AND MINIMUM 2M² DIATOMACEOUS EARTH FILTER. CONNECT WITH 38 mm Ø HIGH PRESSURE PVC PIPES AND FITTINGS TO ALL SUCTION AND RETURN LINES.
ADDENDA:
INSTALLATION: TO MINIMUM REQUIREMENTS OF S.A.A. CODE 1838 - 1975.



RIBS FORMED ON VERTICAL WALLS AND UNDER STEPS

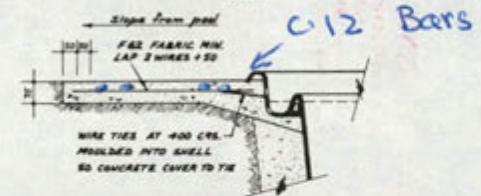

REINFORCEMENT & COPING DETAIL

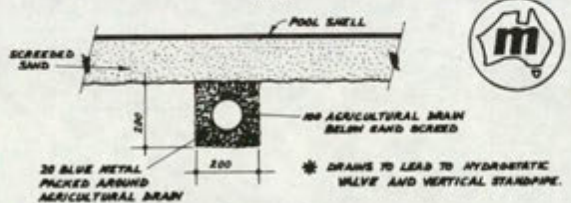

TYPICAL AGRICULTURAL DRAIN

PROPOSED FIBREGLASS SWIMMING POOL
 For: Mr. Mrs. Andy Kenner.
 97 Fittell St Garrahan.

MANUFACTURED BY
UNITED FIBREGLASS INDUSTRIES PTY. LTD.
 HEAD OFFICE & FACTORY: 1 Princes Highway, YALLAH, N.S.W., 2530.
 CORRESPONDENCE TO: P.O. Box 26, DAPTO, N.S.W., 2530.

DISTRIBUTED BY: Cool Pools of Canberra.
 BUILDER: Mr. D. Terpstra c/o Cool Pools.

Date: 24/9/79
 Scale: 1:500
 Drawing No: 844
 Drawn: MK
 UNITED FIBREGLASS INDUSTRIES Engineering Division.

105

PLANS/FILE No. 28
 Received Building Section 3
 20 MAR 1980
 Dept. of the Capital Territory

Department of the Capital Territory
Building Section

Form 4
 Australian Capital Territory
 Building Ordinance 1972
 Regulation 21
 12270380204059

1500NO REC'D

APPLICATION FOR APPROVAL OF PLANS AND SPECIFICATIONS
 BL 1/6 (4/77)

Name of Applicant <i>G. MOORE / M SMITH</i>	Address <i>PO BOX 453 Kingston ACT 2601</i>
--	--

Name of lessee / owner of parcel of land <i>A. I. KEMMER</i>	Address (Show P.O. Box No. if any) <i>c/o ABOVE</i>
---	--

Description of the building work <i>Retaining Wall EXT. change room</i>	Description of land on which the building work is to be carried out.		
	Block <i>29</i>	Section <i>8</i>	Division <i>Garron</i>
To be specified in accordance with the appropriate classification in the Building Manual.	Type of Construction <i>BRICK</i>		Cost <i>\$ 2500.00</i>
	Class of occupancy <i>(10)</i>		Total floor area where applicable. <i>6 sqm.</i>

This application is for

(Please tick appropriate box)

New work Amendment to approved plan Amendment to plan not yet approved Details

I hereby apply for approval of the attached plans and specifications.

..... *[Signature]* *29.3.80*
 Signature of Applicant Date

To be completed if application made otherwise than by the lessee/owner, his solicitor or architect.

I hereby authorise the abovenamed applicant of the address indicated to make this application on my behalf.

+ *[Signature]*
 Signature of lessee/owner Date

"NO SURVEY CERTIFICATE REQUIRED."

FOR OFFICE USE ONLY	Area	Plans Numbered <i>13330/6</i>	Building Covenant
	Valuation \$		\$
	Total Fees Payable <i>\$15.00</i>	Plans <input checked="" type="checkbox"/> Approved <i>C</i> <input type="checkbox"/> Not Approved	
	Receipt/Docket No. <i>[Signature]</i> Deputy Building Controller Date	

PERMIT TO CARRY OUT BUILDING WORK

BL1/9 (1/78)

Permit No. 130445	Date of Issue 24 10 80	Block 129	Section 118	Suburb GARRAN
----------------------	---------------------------	--------------	----------------	------------------

THIS PERMIT WILL LAPSE

15 months after date of issue unless otherwise extended by the Building Controller. Application for extension must be made before permit lapses and extension fee paid otherwise a new permit is necessary and full permit fee payable. If work is not commenced no refund is payable unless permit is surrendered before it lapses.

ISSUED TO:

Permit Holder Details

Initials A I	Surname KENNER	OB
-----------------	-------------------	----

Address
97 Fitchett St
Garran ACT 2605

Nominee (if applicable)

Initials	Surname
----------	---------

CLASS OF BUILDERS LICENCE NA	Plan No. 113330G
Register Folio No.	Cost \$ 250000
Type of Building Construction Code No. 11	Description of Work Back toilet & shower
Class of Occupancy 1	

ENDORSEMENTS Under Section 36 Inspections - Each stage specified overleaf which applies to the building work must be inspected before proceeding beyond that stage. Stages may be grouped as indicated overleaf.

**EXCLUDING INSPECTION STAGES 1 & 2
GROUPING OF INSPECTIONS NOT PERMITTED**

NO BUILDERS LICENCE REQUIRED

**"NO SURVEY CERTIFICATE REQUIRED."
LESSEE/BUILDER RESPONSIBLE FOR CORRECT SITING**

The building work shall be carried out in accordance with the approved plans, the Building Manual A.C.T., the notations made on the plans and subject to the provisions of the Building Ordinance 1972. The approval of plans or the grant of a building permit does not affect the operation of any other law in the Territory nor does it authorise the use of the land contrary to a provision, covenant or condition of the Crown Lease.

S. J. Reichenow
Deputy Building Controller



Permit No.	Date of Issue	Block	Section	Suburb
66936	27 1884	29	18	GARRAN

THIS PERMIT WILL LAPSE

15 months after date of issue unless otherwise extended by the Building Controller. Application for extension must be made before permit lapses and extension fee paid otherwise a new permit is necessary and full permit fee payable. If work is not commenced no refund is payable unless permit is surrendered before it lapses.

ISSUED TO:

Permit Holder Details

Initials	Surname
A.I	KENNER

OIB

Address

97 FITCHETT ST
GARRAN 2605

Nominee (if applicable)

Initials	Surname

CLASS OF BUILDERS LICENCE

N/A

Plan No.

133806

Register Folio No.

Cost \$

1000

Code No.

Description of Work

FINISH TOILET BLOCK + SHOWER.

Type of Building Construction

Class of Occupancy

ENDORSEMENTS Under Section 36 Inspections—Each stage specified overleaf which applies to the building work must be inspected before proceeding beyond that stage. Stages may be groups as indicated overleaf.

NO BUILDERS LICENCE REQUIRED

NO SURVEY CERTIFICATE REQUIRED."

LESSEE/BUILDER RESPONSIBLE FOR CORRECT SITING

NOT TO BE USED OR OCCUPIED
UNTIL A CERTIFICATE AS TO FIT-
NESS FOR OCCUPANCY AND USE
FOR THIS STRUCTURE IS ISSUED.

The building work shall be carried out in accordance with the approved plans, the Building Manual A.C.T., the notations made on the plans and subject to the provisions of the Building Ordinance 1972. The approval of plans or the grant of a building permit does not affect the operation of any other law in the Territory nor does it authorise the use of the land contrary to a provision, covenant or condition of the Crown Lease.

S. J. Reichened
Deputy Building Controller

PLANS/FILE No. **133206**
 Received Building Section
 28 MAR 1980
 Dept. of the Capital Territory

5/2.

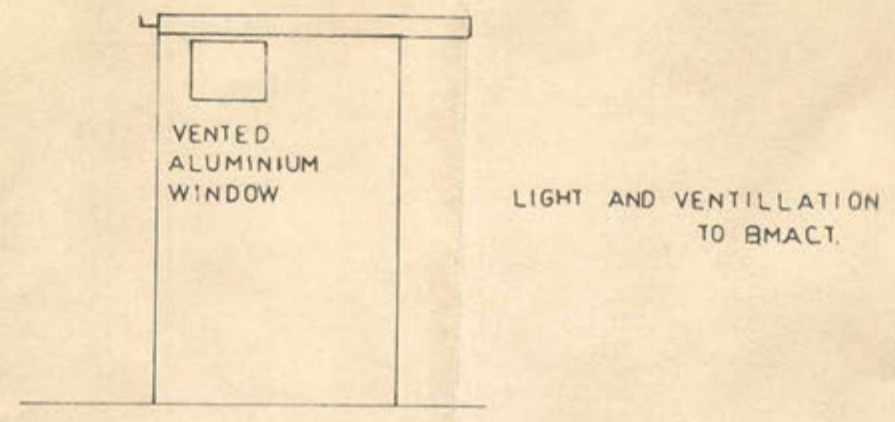

ELEVATION 'A'

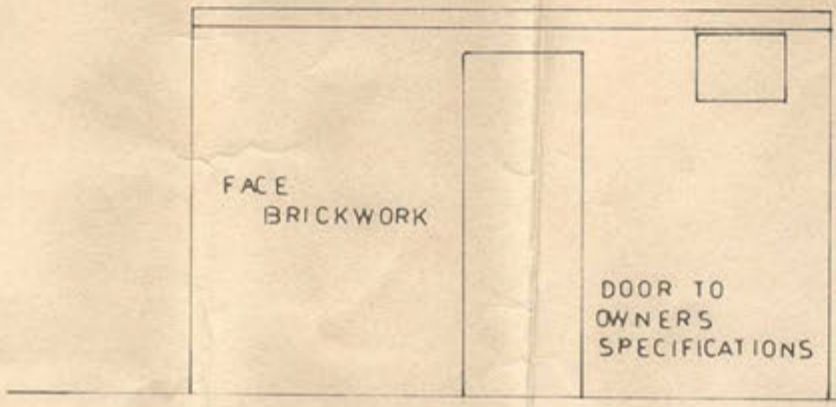

ELEVATION 'C'

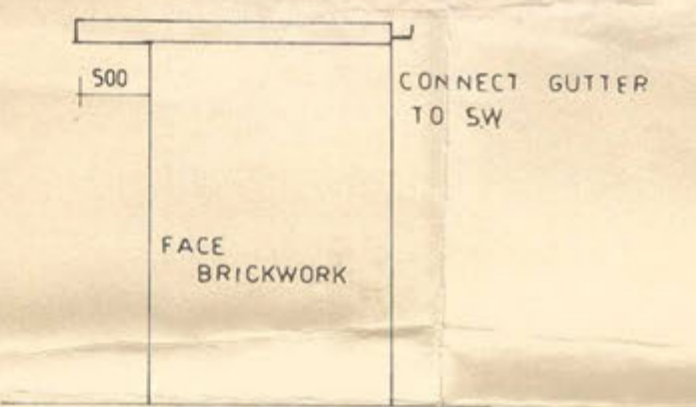

ELEVATION 'B'

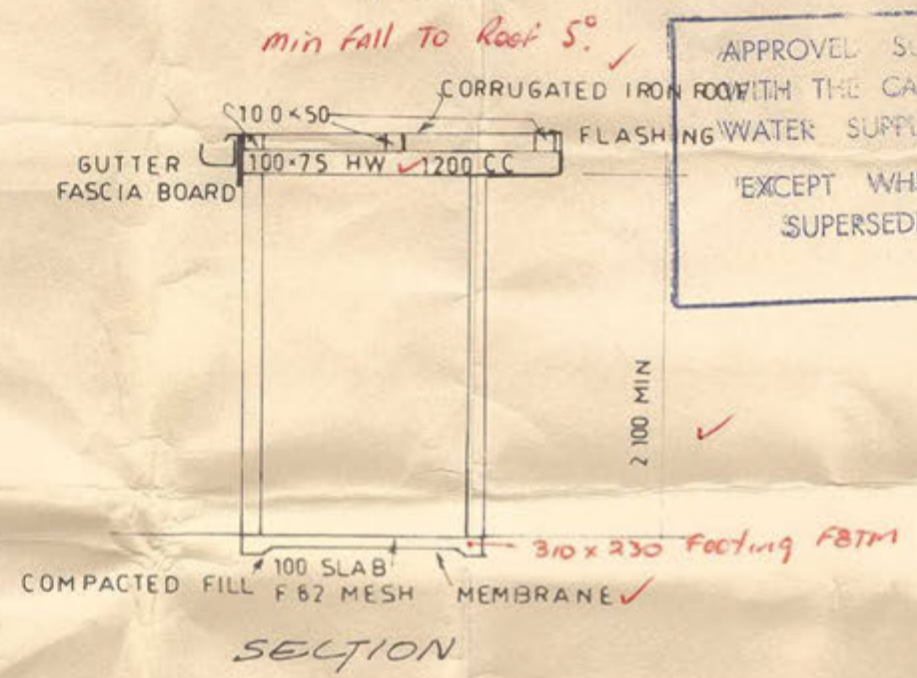

SECTION

APPROVAL SUBJECT TO COMPLIANCE WITH THE GAMBERRA SEWERAGE AND WATER SUPPLY REGULATIONS. EXCEPT WHERE SUBJECT TO AND SUPERSEDED BY THE BUILDING MANUAL

FOOTINGS TO BE TAKEN DOWN TO SOLID GROUND

DEPTH OF FILL UNDER SLAB NOT TO EXCEED 400 mm

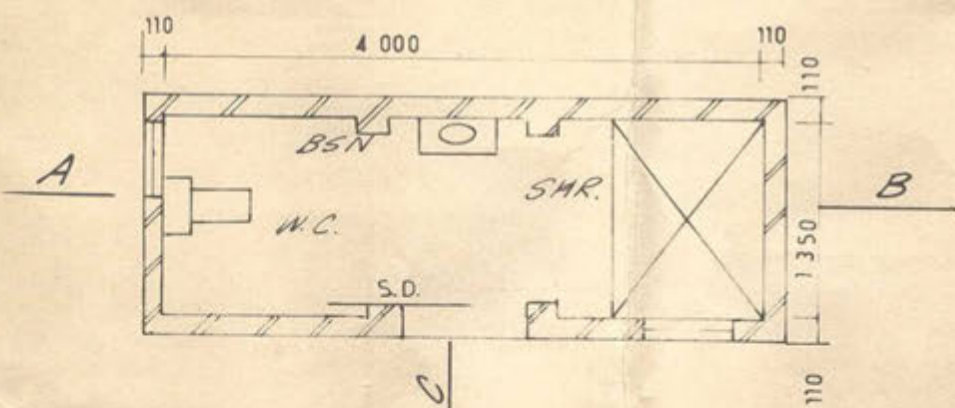

FLOOR PLAN

ALL REGULATIONS EXAMINED AND APPROVED FOR APPROVAL BY
[Signature] 11/4/80
 ENGINEER FOR WATER SUPPLY AND SEWERAGE
 CHIEF ELECTRICAL ENGINEER 1/19
[Signature] 16/4/1980
 STRUCTURAL ENGINEER
 SENIOR TECHNICAL OFFICER 1/19

BUILDING WORK SHALL BE CONSTRUCTED IN ACCORDANCE WITH THE APPROVED PLANS THE BUILDING MANUAL ACT, THE NOTATIONS MADE ON THE PLANS AND ANY MATTERS SPECIFIED ON THE BUILDING PERMIT. THE APPROVAL OF PLANS OR THE GRANT OF A BUILDING PERMIT DOES NOT AFFECT THE OPERATION OF ANY OTHER LAW IN THE TERRITORY, NOR DOES IT AUTHORISE THE USE OF THE LAND CONTRARY TO A PROVISION, COVENANT OR CONDITION THEREIN.
 MODIFICATION NOT PERMISSIBLE

BUILDINGS (DESIGN AND CONSTRUCTION) ORDINANCE 1934 AS AMENDED APPROVAL GRANTED
 10 APR 1980
[Signature]
 ELECTRICIAN
 CAPITAL TERRITORY COMMISSION

RL 'A' 0.00
 RL 'B' 1.00

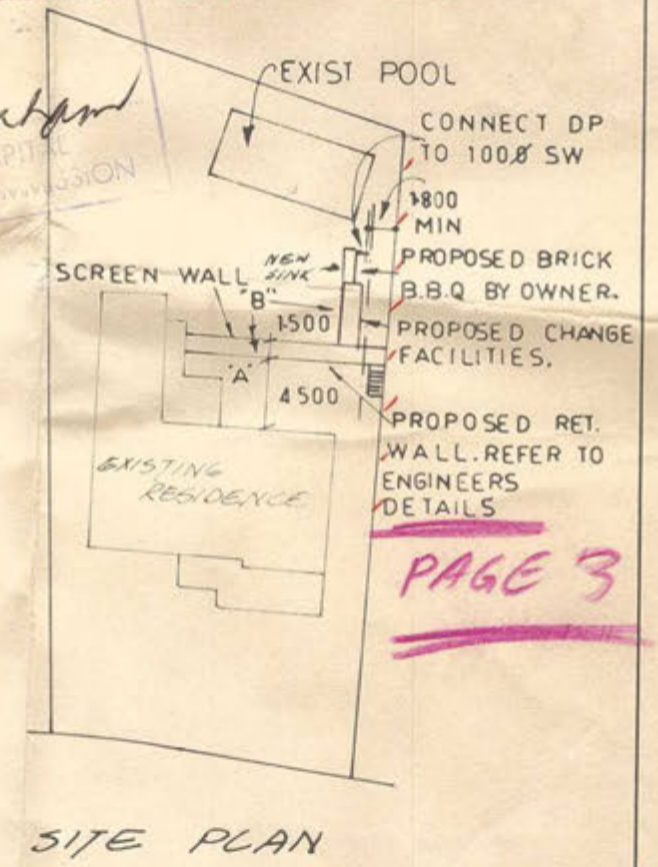

SITE PLAN

PAGE 3

ALL WORK TO CONFORM TO BMACT AND RELEVANT SAA CODES
 THIS PLAN TO BE READ IN CONJUNCTION WITH ENGINEERING DETAILS FOR SCREEN WALL AND RETAINING WALL.

APPROVED FOR CONSTRUCTION BY THE HOLDER OF A CLASS 'C' LICENCE.
 CLASS OF OCCUPANCY: RESIDENCE I
 OUTBUILDINGS X
[Signature] 17-4-80
 DEPUTY BUILDING CONTROLLER

PROPOSED ADDITIONS:
 MR & MRS A.I. KENNER
 BLOCK: 29, SECTION: 8 GARRAN
 DESIGN: MOORE & SMITH PTY LTD
 PLUMBING & DRAINAGE CONSULTANTS. PH 804 226.
 SCALES: 1:500
 1:50
 DWG. NO. D45/MS1

PLANSHEET No. 1330/2
Received Building Section
28 MAR 1980
Dept. of the Capital Territory

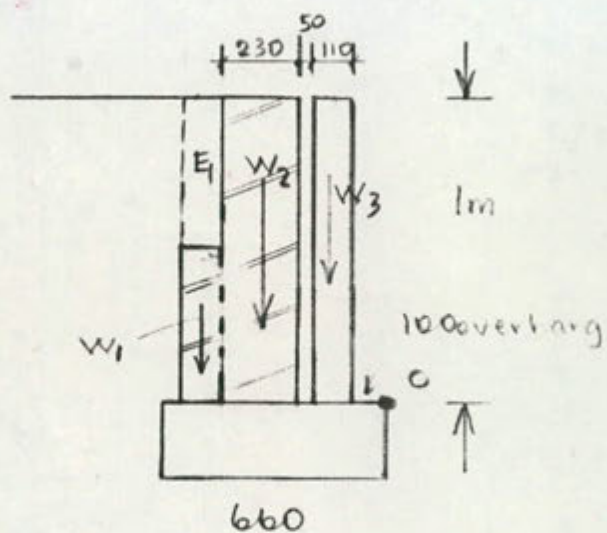

Backfill - Sand

$$\gamma = 20 \text{ kN/m}^3, \phi = 35^\circ$$

$$K_a = \frac{1 - \sin 35^\circ}{1 + \sin 35^\circ} = 0.271$$

$$P_a = K_a \gamma H$$

$$= 0.271 \times 20 \times 1 = 5.420 \text{ kPa}$$

$$P = \frac{1}{2} P_a H = \frac{1}{2} \times 5.420 \times 1$$

$$= 2.710 \text{ kN/m}$$

$$\text{Overturning Moment } M_o = 2.710 \times \frac{1}{3} = 0.903 \text{ kNm/m}$$

Resisting Moment (about O)

$$W_1 = 2.1 \times 0.5 \times 1 = 1.05 \times 0.555 = 0.58$$

$$W_2 = 4.2 \times 1 \times 1 = 4.2 \times 0.375 = 1.58$$

$$E_1 = 2.3 \times 0.5 \times 1 = 1.15 \times 0.555 = 0.64$$

$$W_3 = 2.1 \times 1 \times 1 = 2.1 \times 0.155 = 0.33$$

$$\sum 8.5 \text{ kN} \quad \sum 3.12 \text{ kNm/m}$$

$$\text{F. of S (Overturning)} = \frac{M_r}{M_o} = \frac{3.12}{0.903} = 3.46 > 2$$

$$\text{F. of S (Sliding)} = \frac{0.555 \times 8.5}{2.7} = 1.73 > 1.5$$

Pressure on footing

$$\text{Location of Resultant force} = \frac{3.12 - 0.903}{8.5} = 260 \text{ mm}$$

$$e = \frac{660}{2} - 260 = 70 \text{ mm} \quad \frac{660}{6} = 110 \text{ mm}$$

falls within middle third

$$P_1 = \frac{V}{bd} \left(1 + \frac{6e}{d} \right) = \frac{8.5}{0.66 \times 1.0} \left(1 + \frac{6 \times 0.070}{0.66} \right) = 21 \text{ kPa}$$

$$P_2 = \frac{V}{bd} \left(1 - \frac{6e}{d} \right) = \frac{8.5}{0.66 \times 1.0} \left(1 - \frac{6 \times 0.070}{0.66} \right) = 4.7 \text{ kPa}$$

28 MAR 1980
Dept. of the Capital Territory

Footing
(designed
for house
loading
as below)

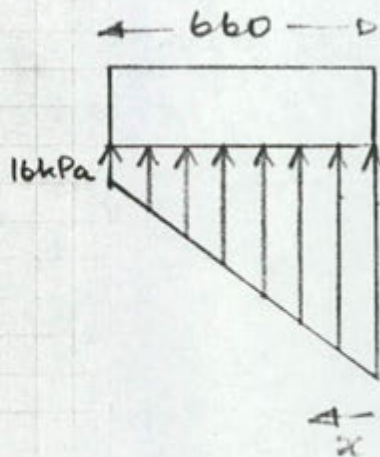

$$q = 164 - 224x$$

$$Q = 164x - \frac{224x^2}{2}$$

$$M = \frac{164x^2}{2} - \frac{224x^3}{6}$$

when $x = 0.66$
 $M = 25 \text{ kNm}$

L.F.
 $A_{st} = \frac{25 \times 18}{0.9 \times 0.9 \times 250 \times 450}$
 $= 493 \text{ mm}^2/\text{m}$

USE F81 mesh $A_{st} = 503 \text{ mm}^2/\text{m}$

Future House loading - 2 storey

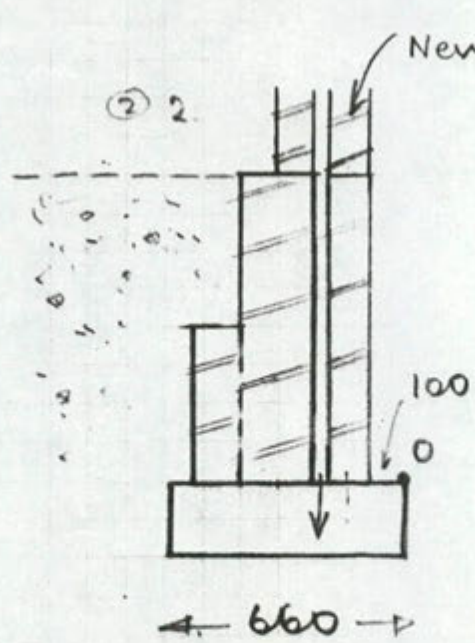

Additional M_r , about 0.

$$51 \times (100 + 110 + 25) = 11.99 \text{ kNm}$$

$$\frac{85}{3.12}$$

$R_y = 59.5 \text{ kN}$ $M = 15.11 \text{ kNm}$

$$\bar{x} = \frac{15.11 - 0.903}{59.5} = 240 \text{ mm}$$

$$e = \frac{660}{2} - 240 = 90, \text{ in middle } \frac{1}{3}$$

$$p_{toe} = \frac{V}{bd} \left(1 + \frac{6e}{d} \right) = \frac{59.5}{0.66 \times 1.0} \left(1 + \frac{6 \times 0.09}{0.66} \right) = 164 \text{ kPa}$$

$$p_{heel} = \frac{V}{bd} \left(1 - \frac{6e}{d} \right) = 16 \text{ kPa}$$

10/1/74

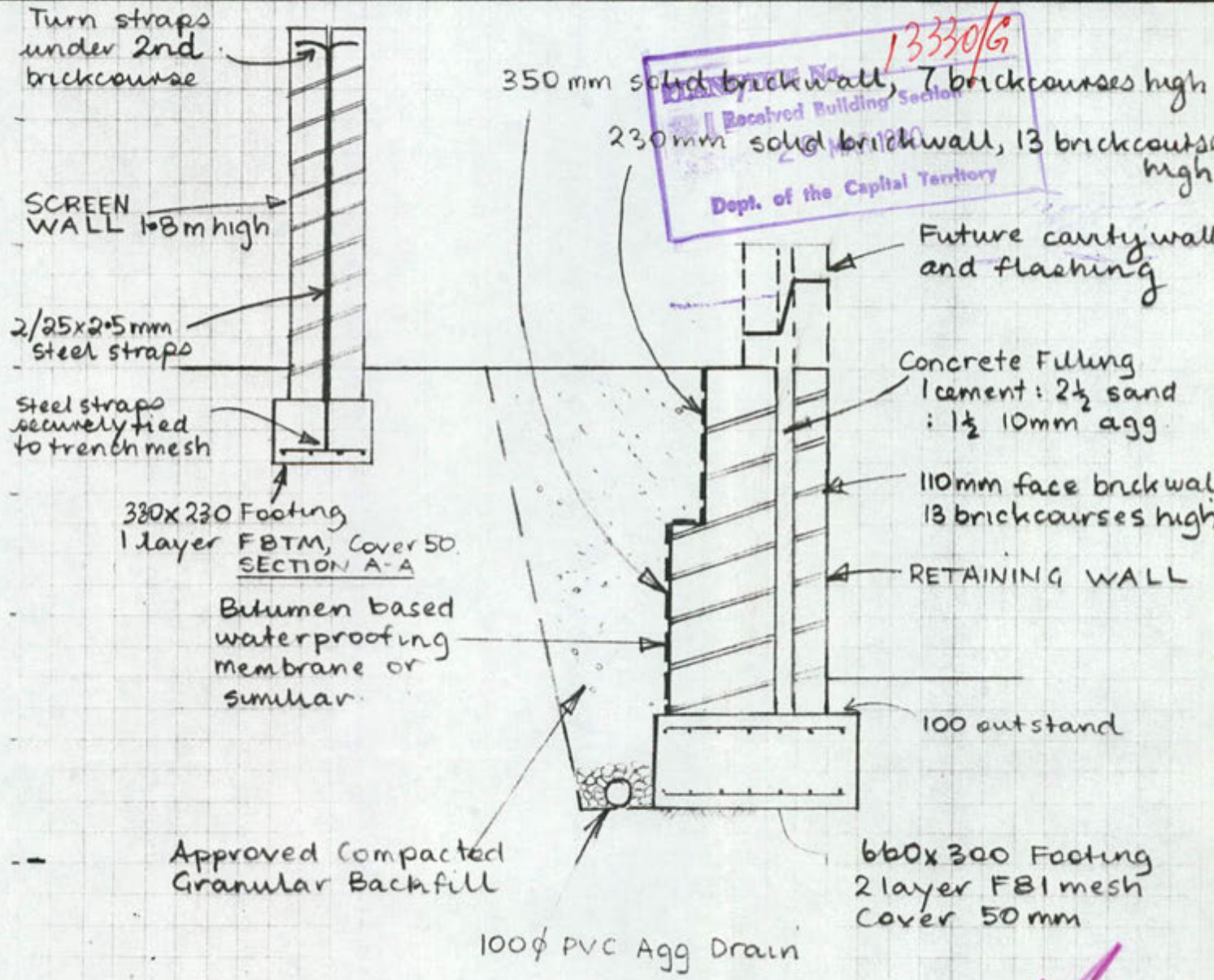

13330/G
No. 13330/G
Received Building Section
20 MAR 1980
Dept. of the Capital Territory

W/h
16/4/80

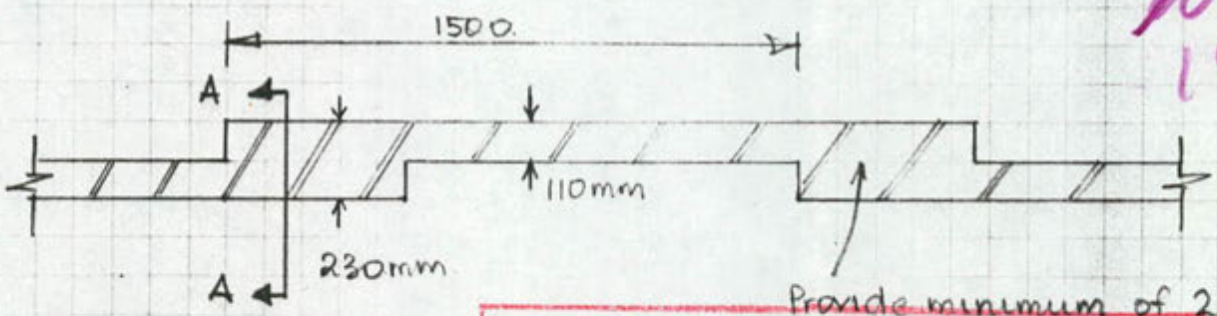

Provide minimum of 2 brick length overlap 470mm

APPROVED FOR CONSTRUCTION BY THE HOLDER OF A CLASS " " LICENCE

PLAN AS SHOWN WALL RESIDENCE I
OUTBUILDINGS X

M. J. J. J.

Scale 1:20

SCREEN WALL and RETAINING WALL

Block 29 Section 8 Carran.

SCREEN WALL CALCULATIONS

1/3

Block 29 Section 8 GARRAN DE LEUW CATER OF AUSTRALIA PTY. LTD
P.O. Box 815, Canberra City A.C.T. 2601

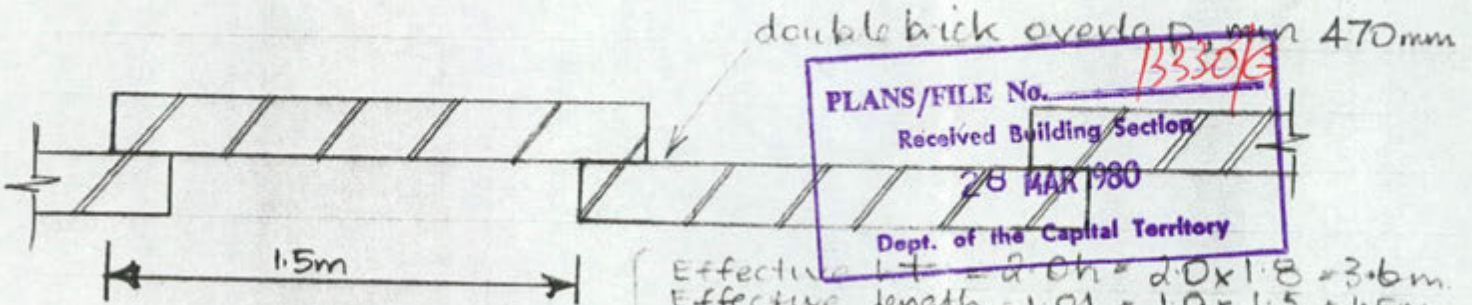

PLANS/FILE No. 13330/3
Received Building Section
26 MAR 1980
Dept. of the Capital Territory

Effective height = $2.0h = 2.0 \times 1.8 = 3.6m$
 Effective length = $1.0L = 1.0 \times 1.5 = 1.5m$
 Effective thickness = $1.4t = 1.4 \times 110 = 154mm$
 Slenderness Ratio = $\frac{1.5}{0.154} = 10 < 27 OK$

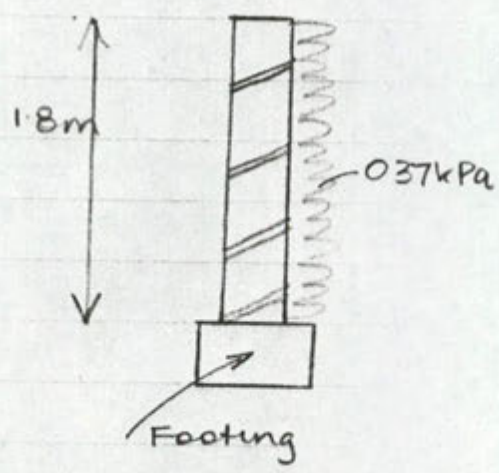

Wind $V = 38 m/s$ multiplier = 0.65
 $V' = 0.65 \times 38 = 24.7 m/s$
 $q_3 = 0.6 \times (24.7)^2 \times 10^{-3} = 0.37 kPa$
 $C_D = 1.2$
 $Area = 1.8 \times 1.5 = 2.7$
 $F = C_D A q_3 = 1.2 \times 2.7 \times 0.37 = 1.2 kN$
 $M = 1.2 \times 0.9 = 1.08 kNm$

Bending - consider brick panel

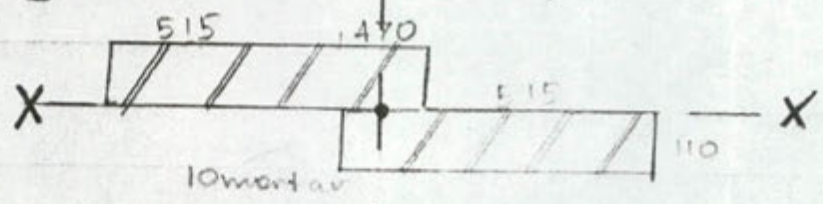

$I_{xx} = 2 \left(\frac{110^3 \times 985}{12} + 985 \times 110 \times 60^2 \right)$
 $= 9.99 \times 10^8 mm^4$
 $Z_{xx} = 8.68 \times 10^6 mm^3$

$f_b = \frac{M}{Z_{xx}} = 124 kPa$

Dead weight

Area wall = $(515 \times 2 + 470 \times 2) \times 1.8 = 3.55 m^2$
 Dead load = $2.1 kN/m^2 \therefore W_D = 2.1 \times 3.55 = 7.45 kN$

20/74

Screen Wall Calculation
Block 29 Section B Garran

DE LEUW CATER OF AUSTRALIA PTY. LTD
P.O. Box 815, Canberra City A.C.T. 2601

$$\text{Area base} = 2 \left[(515 + 470) \times 110 \right] = 216,700 \text{ mm}^2$$

$$f_c = \frac{W_D}{A_b} = \frac{745 \text{ kN}}{216,700 \text{ mm}^2} = 34 \text{ kPa}$$

PERMIT No. 1333/S/G
 Received Building Section
 28 MAR 1980
 Dept. of The Capital Territory

$$f_t = f_{bt} - f_c = 124 - 34 = 90 \text{ kPa}$$

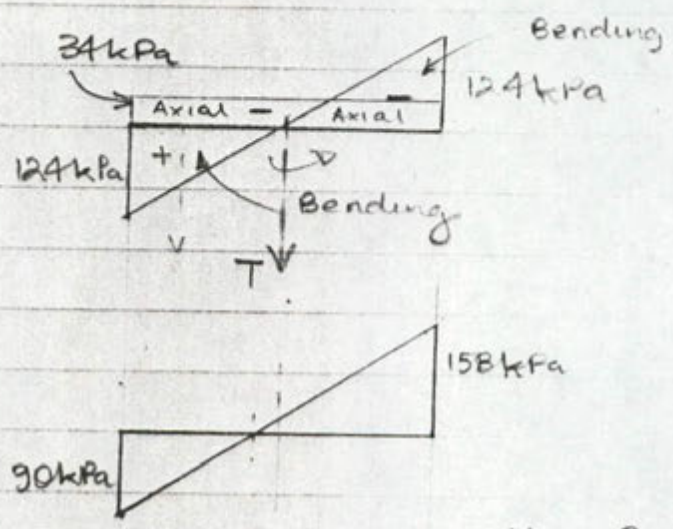

$$F_t = 124 \times 110 \times 985 = 13.4 \text{ kN}$$

$$M = 13.4 \times 110 = 0.49 \text{ kNm}$$

$$e = \frac{M}{W_D} = \frac{0.49}{7.45} = 65 \text{ mm}$$

Use 2 / 2.6mm x 25mm (12 Gauge) iron straps
Area = 65mm²

$$F_b = 140 \text{ MPa}$$

$$P_L = 140 \times 65 = 9 \text{ kN} \times 2 = 18 \text{ kN}$$

Footing 300 x 230

$$M = 0.49 \text{ kNm}$$

$$W_D = 7.45 \text{ kN}$$

$$W_F = 1.3 \times 230 \times 1 \times 24 \text{ kN/m}^3 = 1.66 \text{ kN}$$

$$e = \frac{M}{W_D + W_F} = \frac{0.49}{7.45 + 1.66} = 53 \text{ mm}$$

Handwritten signature/initials

Screen Wall Calculation 29/8 Ciarran

loaded length = $3 \left(\frac{L}{2} - e \right) = 3(150 - 53)$ 13330/9
291 mm

Pactual = $\frac{2 \times 9.11}{291 \times 1000} = 62 \text{ kPa}$ ok ✓

USE: FBTM. trench mesh in footing

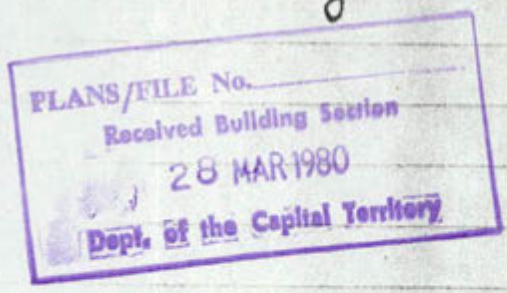

DE LEUW CATHER OF AUSTRALIA PTY. LTD.
P.O. Box 815, Canberra City A.C.T. 2601

Made: AC 20/12/79.

[Handwritten signature]
17/11



113
17/11

APPLICATION FOR APPROVAL OF PLANS

17 NOV 1980
BL 1/6 (2/79)
Dept. of the Capital Territory

12171180Z#1077
Cash Register imprint. 7500NO REC

Name of Applicant MOORE & SMITH P/L Shop 1, Molonglo Ma., FYSHWICK A.C.T. 2609 PH. (062) 80 5226	Address MOORE & SMITH P/L Shop 1, Molonglo Ma., FYSHWICK A.C.T. 2609 Postcode: PH. (062) 80 5226
---	--

Name of lessee /owner of parcel of land <i>A. G. I. Kennan.</i>	Address (Show P.O.Box No. if any) <i>elo</i> MOORE & SMITH P/L Shop 1, Molonglo Mail FYSHWICK A.C.T. 2609 Postcode PH. (062) 80 5226
--	--

Description of the building work.
BRICK - 2 STOREY EXTENSION

Description of land on which the building work is to be carried out.	Block <i>29</i>	Section <i>8</i>	Division <i>Garrahan</i>
--	--------------------	---------------------	-----------------------------

To be specified in accordance with the appropriate classification in the Building Manual.	Type of Construction <i>BRICK.</i>	Cost <i>\$15,000</i> 65,000
	Class of occupancy	Total floor area where applicable <i>63 Sqm.</i>

This application is for:

(Please tick (✓) appropriate box)

New work Amendment to approved plan Amendment to plan not yet approved Details

I hereby apply for approval of the attached plans.

[Signature] 17/11/80
Signature of Applicant Date

To be completed if application made otherwise than by the lessee /owner, his solicitor or architect.	I hereby authorise the abovenamed applicant of the address indicated to make this application on my behalf. <i>X [Signature]</i> Signature of lessee /owner 1/1/80 Date
--	---

FOR OFFICE USE ONLY	<input checked="" type="checkbox"/> New work	Plans Numbered <i>30/H</i>	Class of licence required: <i>B</i>
	<input type="checkbox"/> Amendment to approved plan	Area	Valuation <i>\$15,000</i>
	<input type="checkbox"/> Amendment to plan not yet approved	Total fees payable	
	<input type="checkbox"/> Details	Plans <input checked="" type="checkbox"/> Approved <input type="checkbox"/> Not Approved	
Notify applicant: New permit required Endorse exist. permit.	Permit fee required:	<i>[Signature]</i> 25 NOV 1980 Deputy Building Controller Date	

NO SURVEY CERTIFICATE REQUIRED FOR CONVEYANCING
LESSEE/BUILDER RESPONSIBLE FOR CONVEYANCING



115

Permit No.	Date of Issue	Block	Section	Suburb
1314619	28 11 80	29	118	GARRAN

THIS PERMIT WILL LAPSE

15 months after date of issue unless otherwise extended by the Building Controller. Application for extension must be made before permit lapses and extension fee paid otherwise a new permit is necessary and full permit fee payable. If work is not commenced no refund is payable unless permit is surrendered before it lapses.

ISSUED TO:

Permit Holder Details

Initials	Surname	
F	SCHINZINGER	S342

Address

30 Natdeo Cres
 O'Connor ACT 2601

Nominee (if applicable)

Initials	Surname

CLASS OF BUILDERS LICENCE

10

Plan No.

11333041

Register Folio No.

1171417

Cost \$

115000

Code No.

Description of Work

Type of Building Construction

11

Brick Veneer - 2 storey Extent to
 Residence

Class of Occupancy

1

ENDORSEMENTS Under Section 36 Inspections - Each stage specified overleaf which applies to the building work must be inspection before proceeding beyond that stage. Stages may be groups as indicated overleaf.

"NO SURVEY CERTIFICATE REQUIRED."
LESSEE/BUILDER RESPONSIBLE FOR CORRECT SITING

The building work shall be carried out in accordance with the approved plans, the Building Manual A.C.T., the notations made on the plans and subject to the provisions of the Building Ordinance 1972. The approval of plans or the grant of a building permit does not affect the operation of any other law in the Territory nor does it authorise the use of the land contrary to a provision, covenant or condition of the Crown Lease.

APPROVED FOR CONSTRUCTION BY THE HOLDER OF A CLASS "B" LICENCE.
 CLASS OF OCCUPANCY: RESIDENCE I
 OUTBUILDINGS X
 25 NOV 1980
 DEPUTY BUILDING CONTROLLER

"FULL SPECIFICATIONS WILL BE REQUIRED TO BE SUBMITTED IF PERMIT IS APPLIED FOR BY OWNER-BUILDER".

PLANS/TITLE No. 13330/A
 Received Building Section
 17 NOV 1980
 Dept. of the Capital Territory

BUILDINGS DESIGN APPROVAL
 APPROVAL DATED 20 NOV 1980
 DELEGATE R. Palmer
 NATIONAL CAPITAL DEVELOPMENT COMMISSION

PLANS AND SPECIFICATIONS EXAMINED AND RECOMMENDED FOR APPROVAL BY
 21/11/80
 ENGINEER FOR WATER SUPPLY AND SEWERAGE
 CHIEF ELECTRICAL ENGINEER 1/119
 STRUCTURAL ENGINEER 25/11/1980

DEPARTMENTAL RECORDS INDICATE THAT PORTION OF THE EXISTING SANITARY DRAINAGE SERVICE WILL BE UNDER THE PROPOSED STRUCTURE. ACTION IS TO BE TAKEN TO BRICKWORK TO MATCH EXISTING WITH THE CANBERRA SEWERAGE AND WATER SUPPLY REGULATIONS.

THIS SET CONTAINS 15 SHEETS NUMBERED 1/5 TO 15/5 INCLUSIVE AND SHOULD REMAIN INTACT.

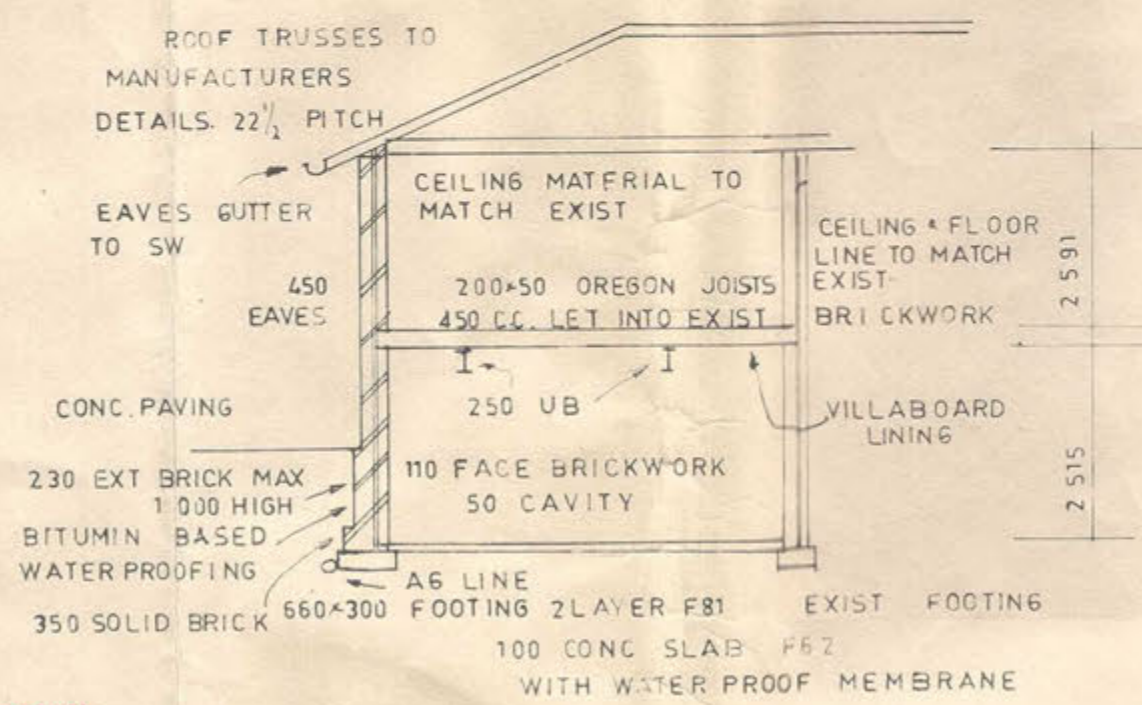

2 1300 MAX

SUBMIT DETAILS FOR APPROVAL PRIOR TO CONSTRUCTION

SECTION

DEPTH OF FILL UNDER SLAB NOT TO EXCEED 400 mm

FOOTINGS TO BE TAKEN DOWN TO SOLID GROUND

CONSTRUCTION MUST COMPLY WITH A.S. 1684.—1979
 TIMBER FRAMING CODE AND RELEVANT SUPPLEMENTS

ROOF TILES TO MATCH EXIST

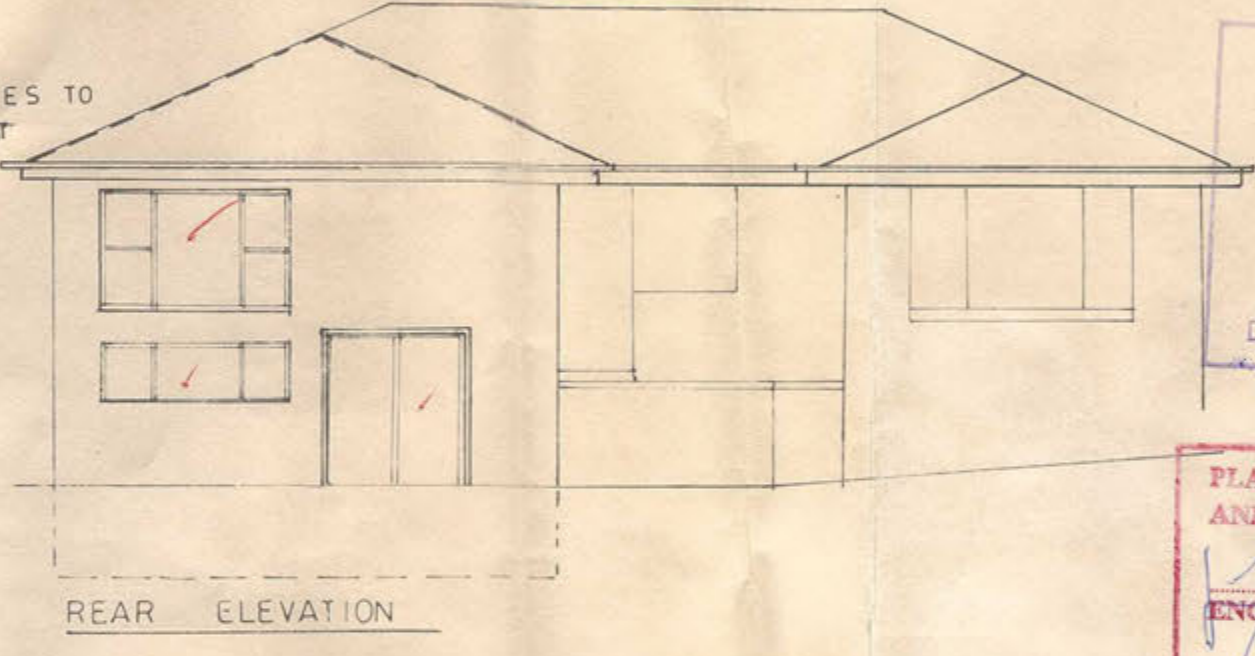

REAR ELEVATION

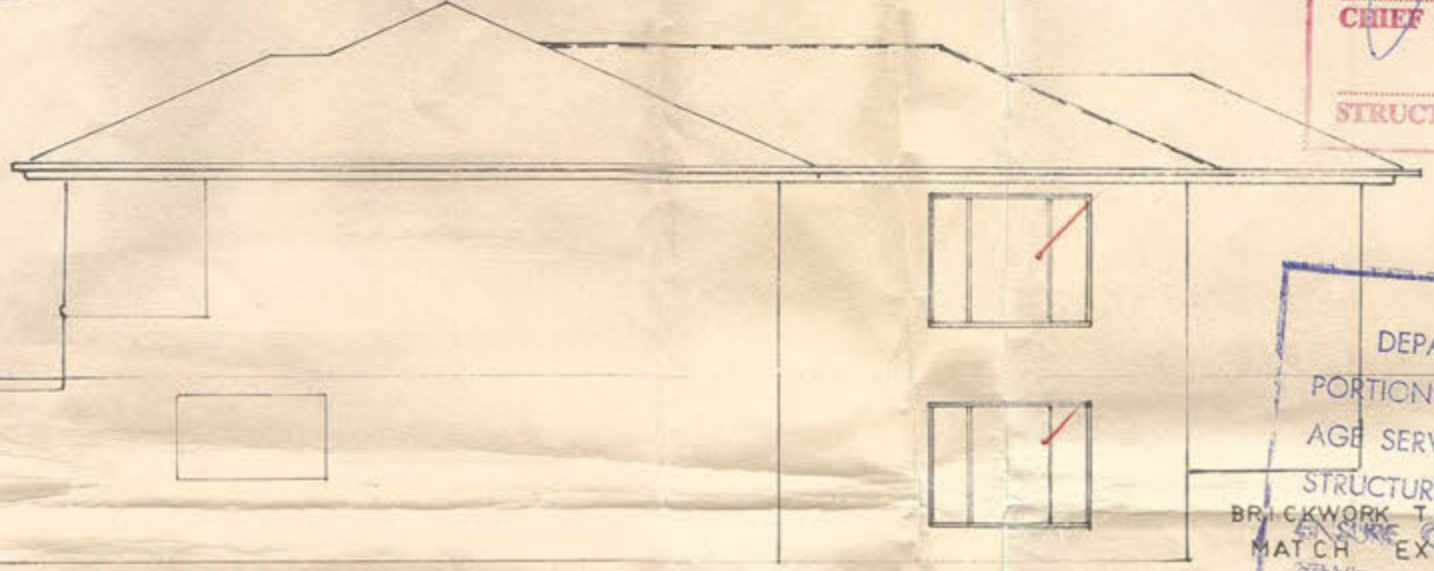

SIDE ELEVATION

* MAINTAIN CAVITY

NO SURVEY CERTIFICATE REQUIRED LESSEE/BUILDER RESPONSIBLE FOR CORRECT SITING

SITE PLAN LEVELS

UPPER LEVEL	0.0
GL 'A' & 'B'	-4.031
LOWER FL. 'A' & 'B'	-5.331
GL 'C'	-5.381

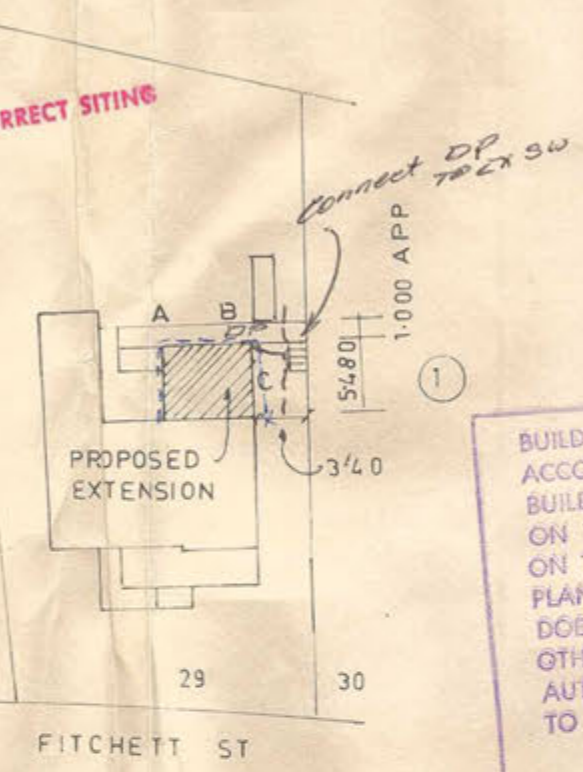

SITE PLAN

LIGHT & VENTILATION TO COMPLY WITH PART 50 OF THE BUILDING MANUAL ACT,

APPROVED IN RESPECT OF NOMINATED AMENDMENTS No's 1 ONLY. ANY OTHER VARIATIONS TO THE ORIGINALLY APPROVED PLAN ARE NOT APPROVED.

- AMENDMENTS
- 1 SITING FOR EXTENSION ALTERED
 - 2 HEIGHT OF RETAINING WALL DETERMINED

ALL WORK TO CONFORM TO BMACT AND RELEVANT S.A.A. CODES

TC 3

TITLE
 PROPOSED AMENDMENT AND EXTENSION
 MR & MRS. A.I. KENNER
 29 B GARRAN ACT
 SCALES 1:100 1:500

DESIGNED
 MOORE & SMITH PLUMBING & DRAINAGE CONSULTANTS
 Unit 1, Melonglo Mall, Fyshwick, Telaphorta 805 226.

SCALE
 1/5

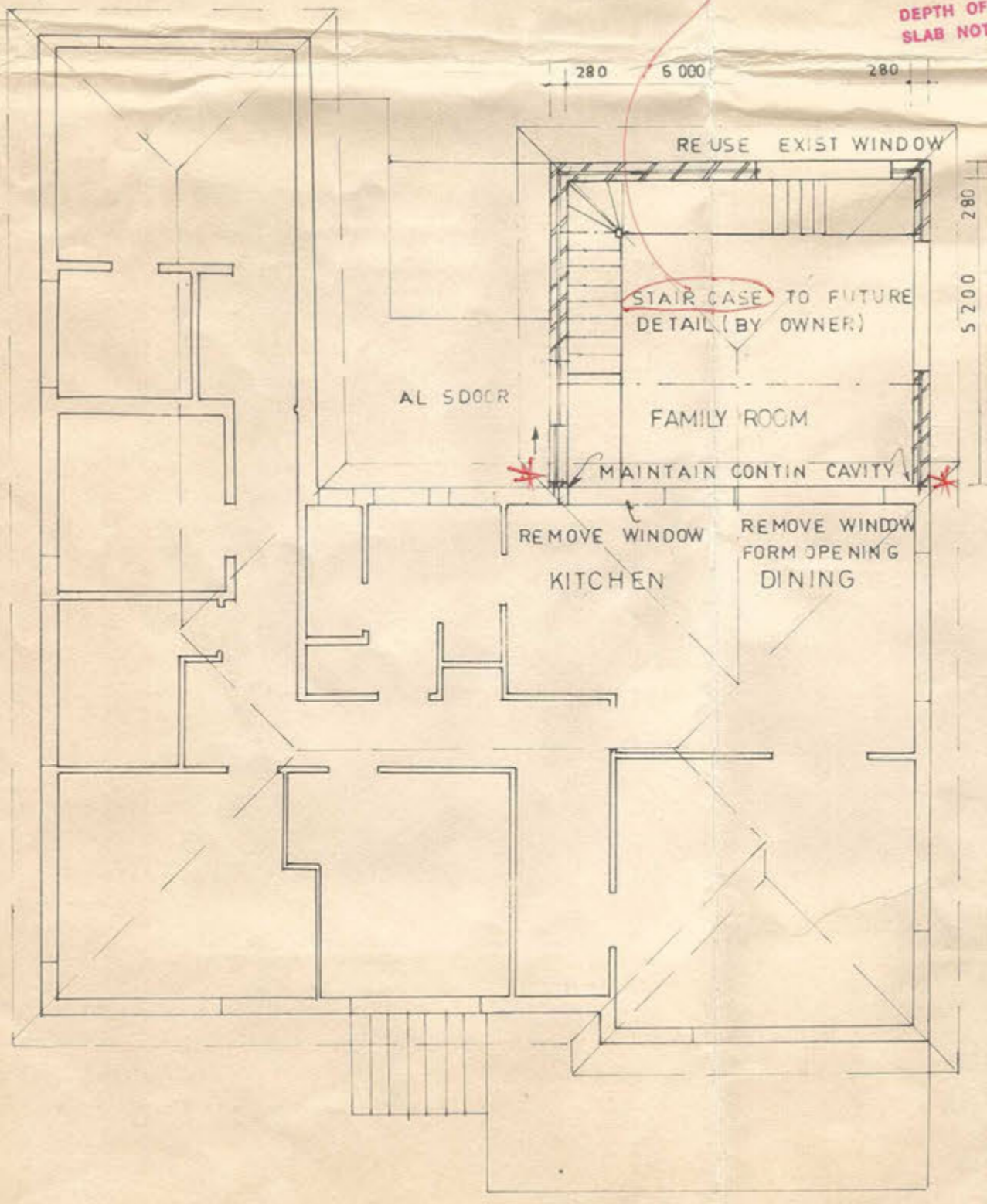

PLAN UPPER LEVEL

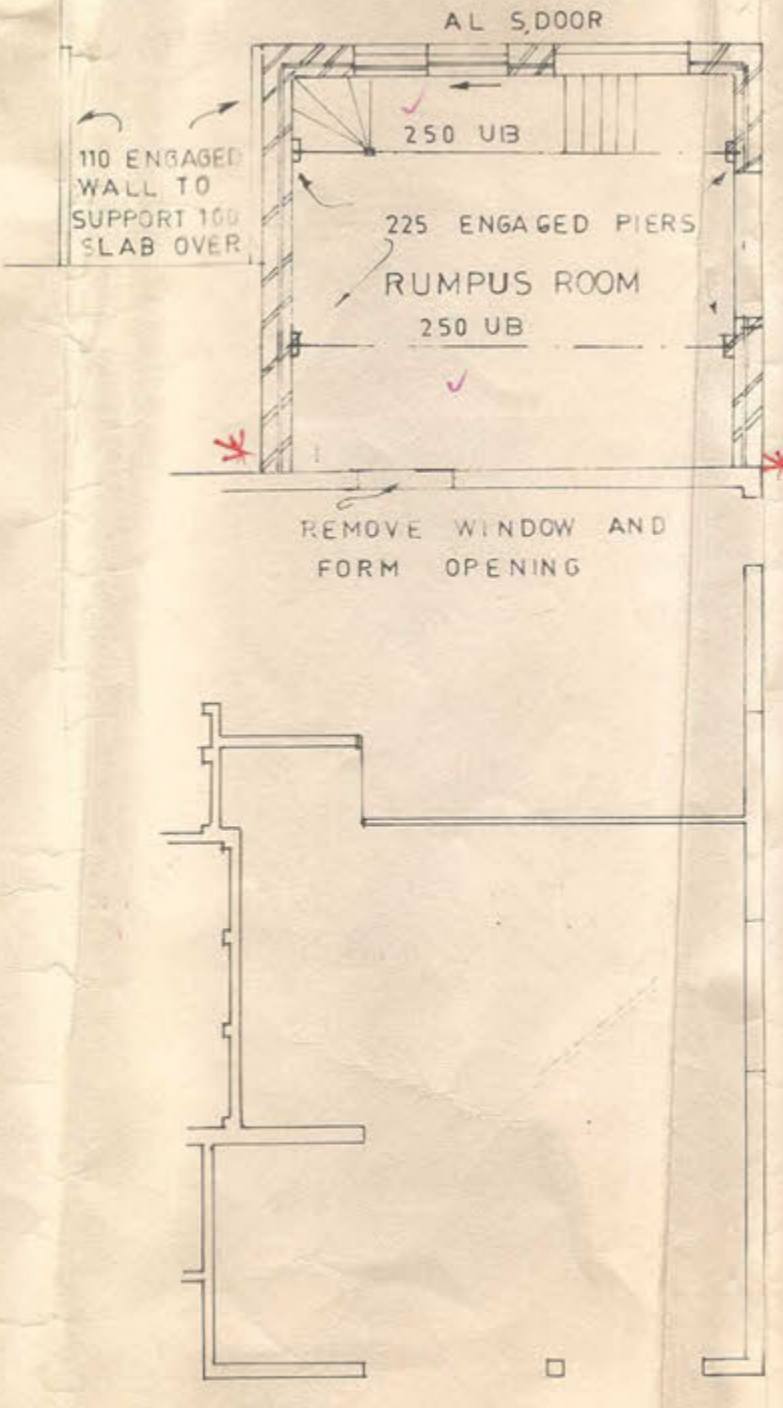

PLAN LOWER LEVEL



Department of the Capital Territory

POST OFFICE BOX 154, CANBERRA CITY, ACT 2601

BUILDING SECTION

North Building, Civic Offices,
London Circuit, 491355

120
3/3

PLANS/FILE No. _____
Received Building Section
31 MAR 1981
Dept. of the Capital Territory

APPLICATION FOR APPROVAL OF PLANS

BL 1/6 (7/80)

Name of Applicant MOORE & SMITH P/L Shop 1, Molonglo Mall FYSHWICK A.C.T. 2609 PH. (062) 80 5226		Address MOORE & SMITH P/L Shop 1, Molonglo Mall FYSHWICK A.C.T. 2609 PH. (062) 80 5226 Postcode	
Name of lessee / owner of parcel of land <i>MARSH A.I. KENNEDY</i>		Address (show P.O. Box No. if any) MOORE & SMITH P/L Shop 1, Molonglo Mall FYSHWICK A.C.T. 2609 Postcode PH. (062) 80 5226	
Description of the building work <i>PROPOSED AMENDMENTS + EXTENSIONS</i>			
Description of land on which the building work is to be carried out		Block <i>29</i>	Section <i>8</i>
		Division (Suburb) <i>GREEN.</i>	
To be specified in accordance with the appropriate classification in the Building Manual.		Type of construction <i>(N/A for Class I or X buildings)</i>	Cost
		Class of occupancy	Total floor area where applicable
This application is for: (please tick appropriate box) <input type="checkbox"/> New work <input type="checkbox"/> Amendment to approved plan <input checked="" type="checkbox"/> Amendment to plan not yet approved <input type="checkbox"/> Details			
I hereby apply for approval of the attached plans, and request that approved plans be -		<i>Cherie Ellison</i> 31.3.81 signature of applicant date	
<input checked="" type="checkbox"/> posted to the applicant's address <input type="checkbox"/> held at the counter for collection (telephone advice will be given when ready for collection)			
To be completed if application made otherwise than by the lessee / owner, his solicitor or architect.		I hereby authorise the abovenamed applicant of the address indicated to make this application on my behalf <i>A. Kennedy</i> 31.3.81 signature of lessee / owner date	

FOR OFFICE USE ONLY	<input type="checkbox"/> New work <input checked="" type="checkbox"/> Amendment to approved plan <input type="checkbox"/> Amendment to plan not yet approved <input type="checkbox"/> Details	Plans numbered <i>13330/5</i>	Class of licence required
	Notify applicant new permit required endorse existing permit Permit fee required	AMENDED IN RESPECT OF NOMINATED AREA ONLY. ANY OTHER AMENDMENTS No's 3-6 VARIATIONS TO THE ORIGINALLY APPROVED PLANS NOT APPROVED.	Valuation
		Total fees payable <i>N/A.</i>	
		Plans <input checked="" type="checkbox"/> Approved <input type="checkbox"/> Not approved	<i>Mulhew</i> 14.5.81 Deputy Building Controller date

SPECIFICATIONS (DIMIN. OF PARTS)

- 5 - ROOF TRUSSES
 RAFTERS: 150 x 50 450 C/C
 C. JOISTS: 150 x 50
~~PROPS: 150 x 50~~
 RIDGE: 200 x 38
 W. PLATES: 100 x 50
 FACIA B. 185 x 32
- CEILING TO MATCH EXIST.
 OREGON FACIA BOARD
 HARDWOOD: REMAINING PARTS.
- 3 - STAIRCASE
 TO BE DONE IN ACCORDANCE
 WITH THE B.M.A.C.T.

S1/2

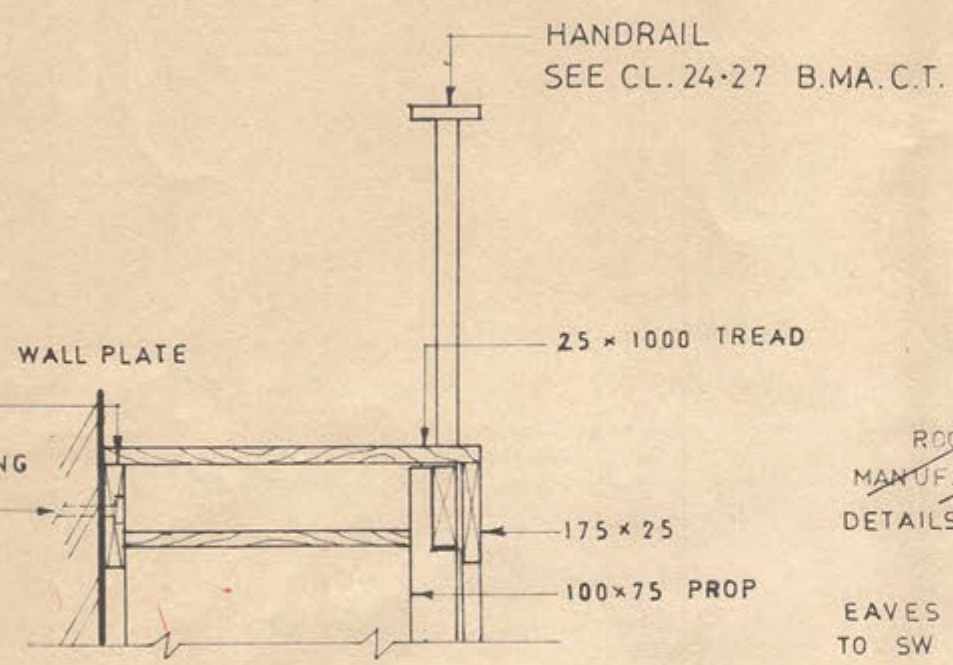

SECTION THROUGH STAIRS 1:2.0

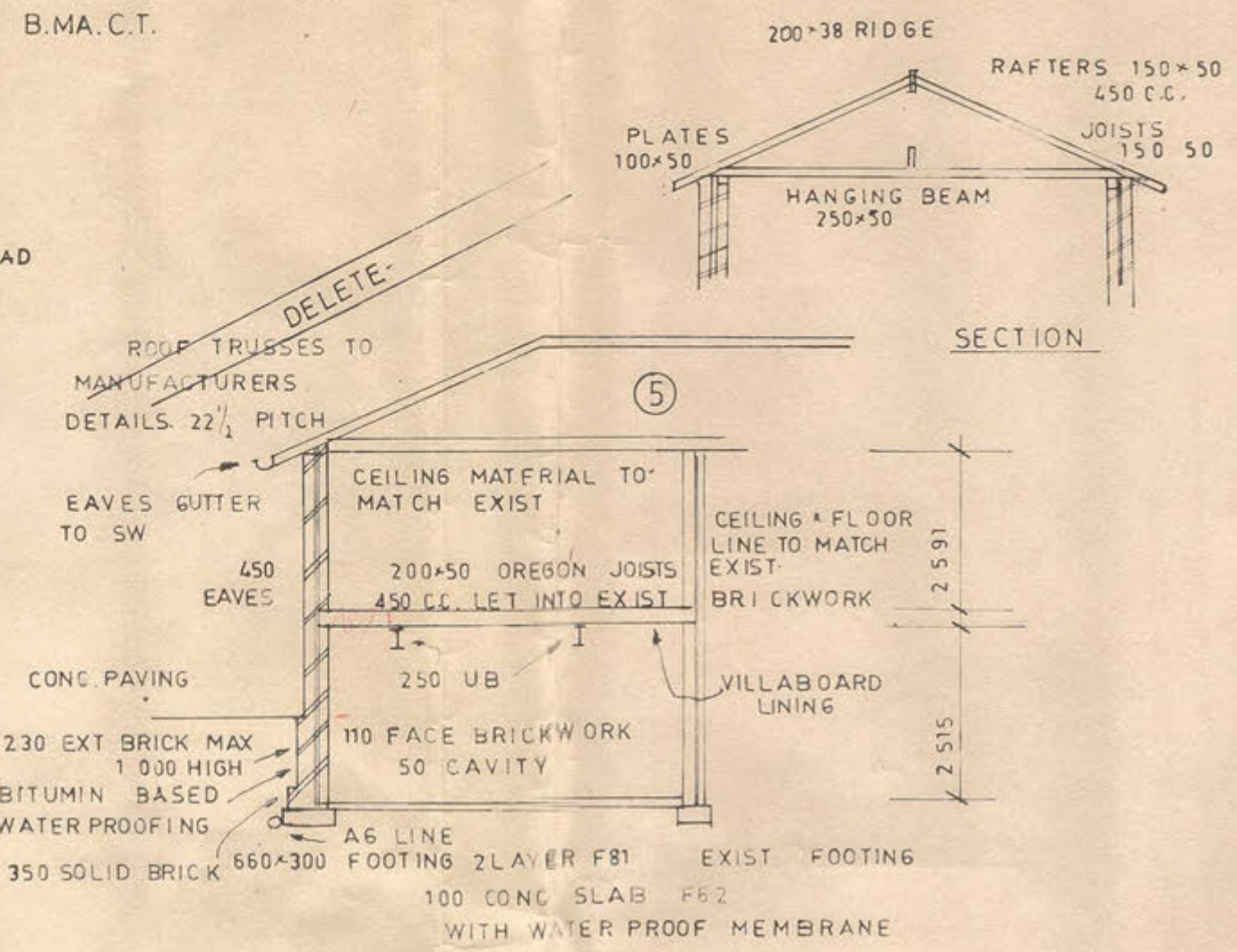
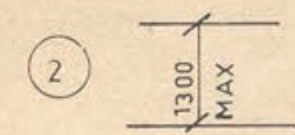

STEPS & HANDRAIL TO COMPLY WITH PART 34 OF THE BUILDING MANUAL ACT

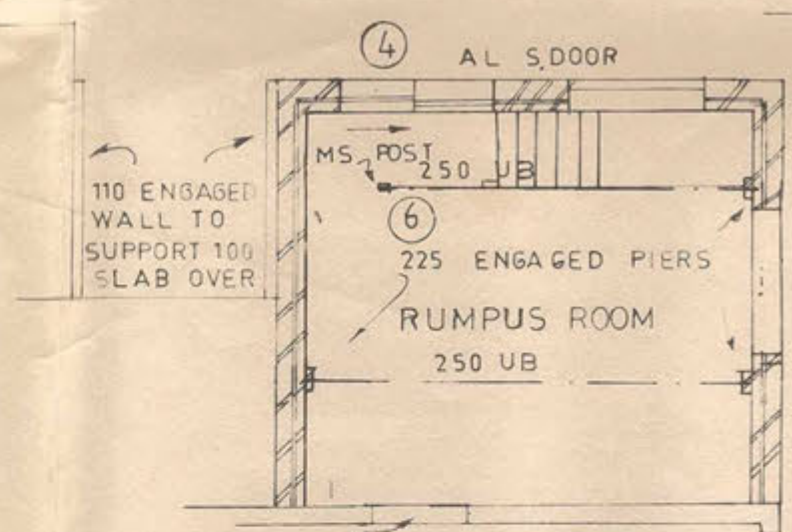
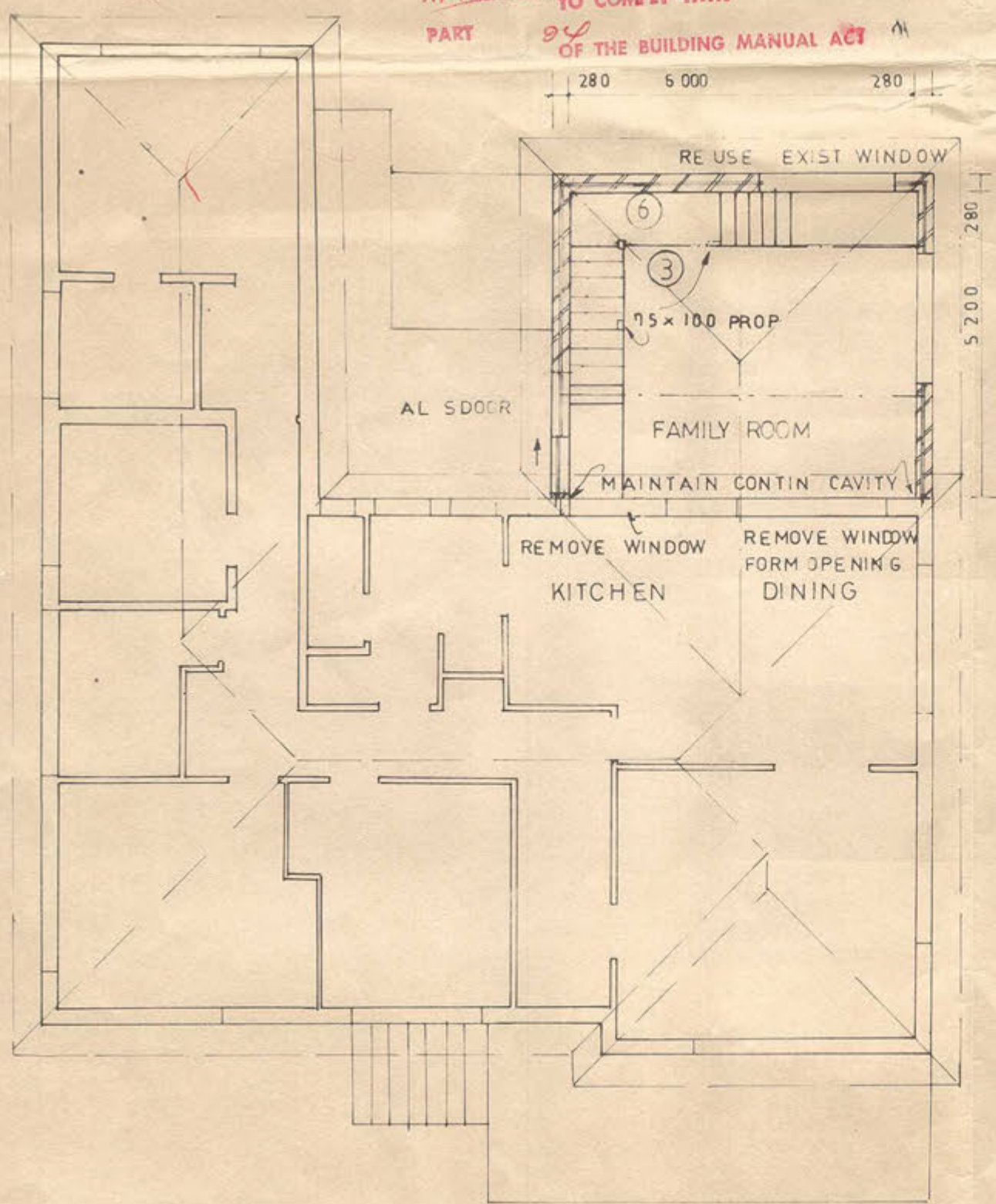
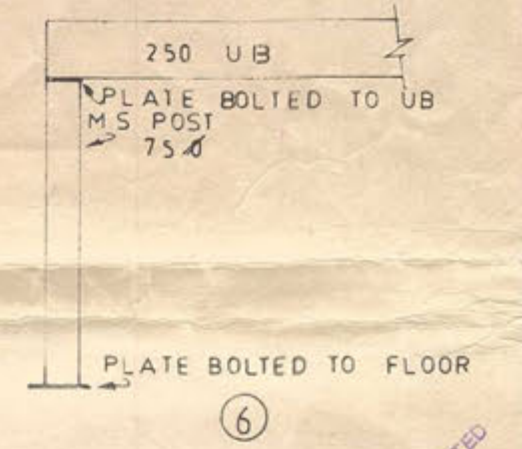
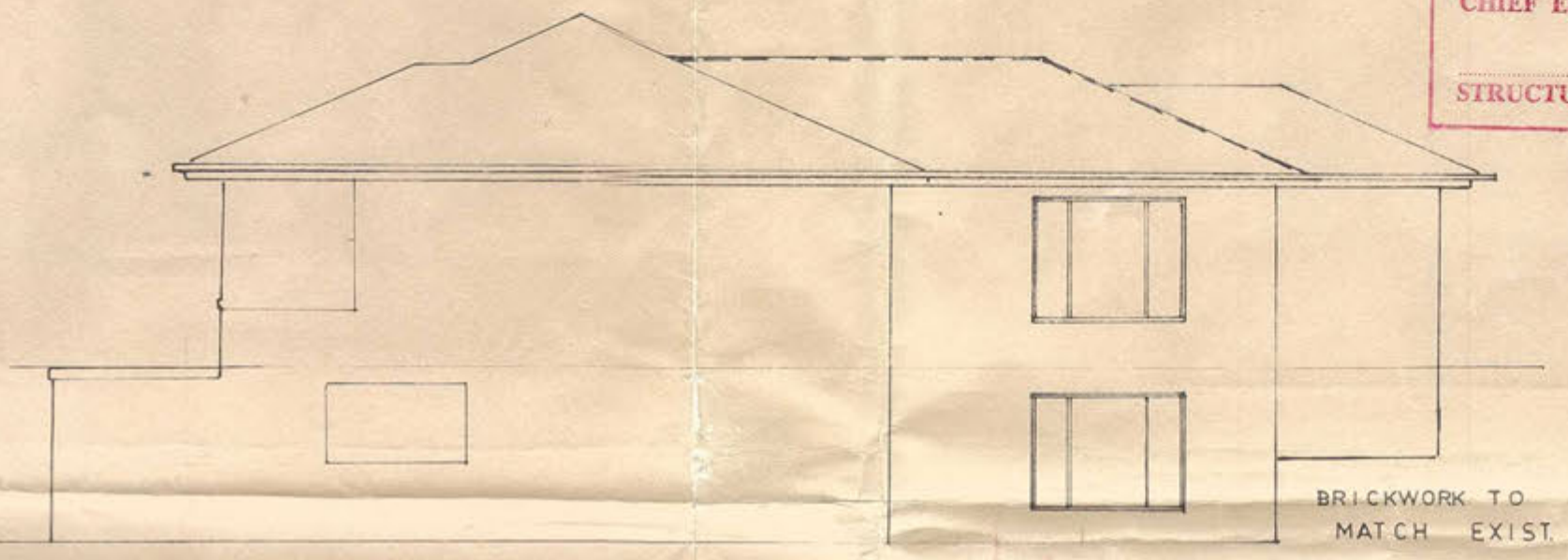
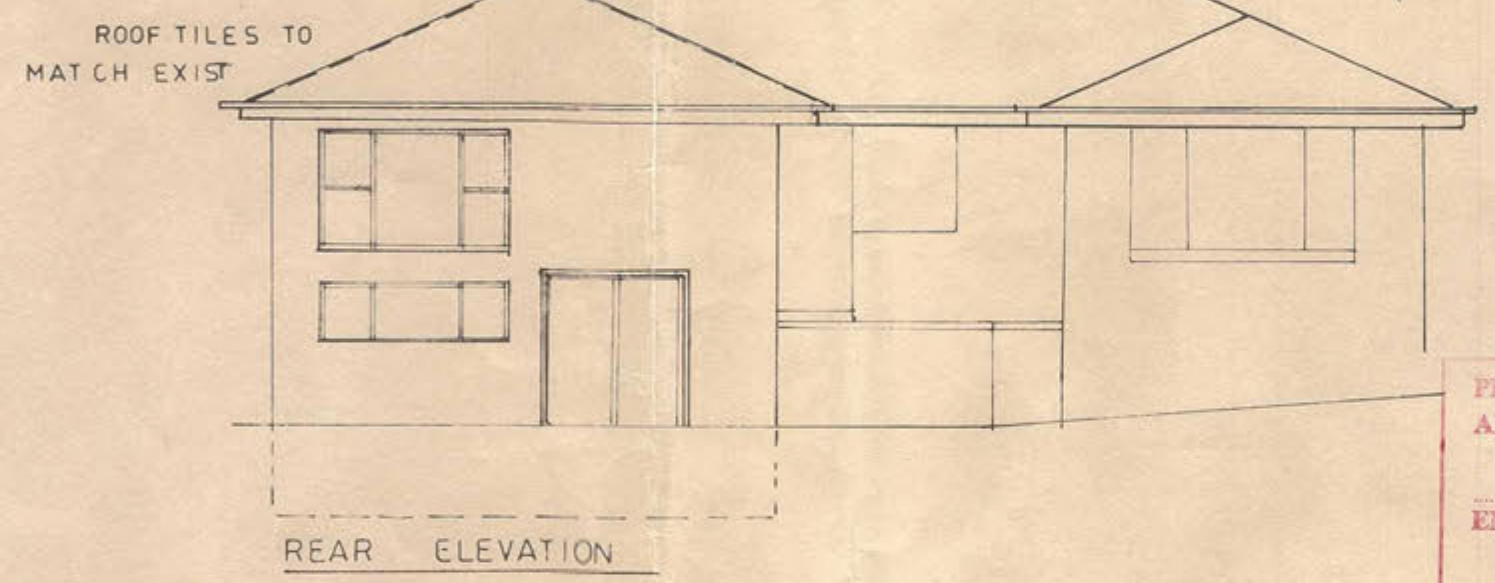

SITE PLAN LEVELS

UPPER LEVEL	0.0
GL A & B	-4.031
LOWER FL. A & B	-5.331
GL C	-5.381

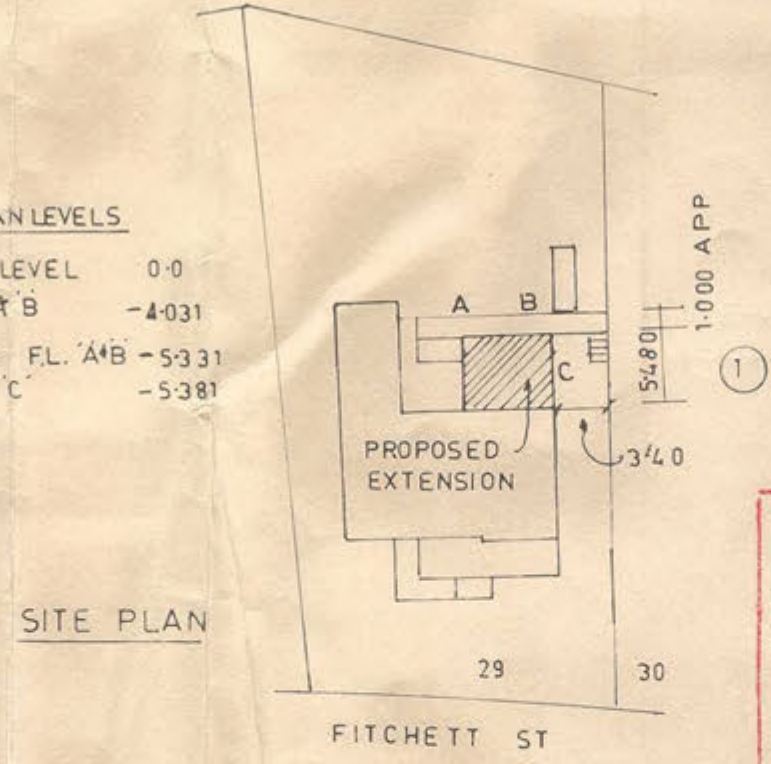

BUILDING WORK SHALL BE CONSTRUCTED IN ACCORDANCE WITH THE APPROVED PLANS THE BUILDING MANUAL ACT, THE NOTATIONS MADE ON THE PLANS AND ANY MATTERS SPECIFIED ON THE BUILDING PERMIT. THE APPROVAL OF PLANS OR THE GRANT OF A BUILDING PERMIT DOES NOT AFFECT THE OPERATION OF ANY OTHER LAW IN THE TERRITORY, NOR DOES IT AUTHORISE THE USE OF THE LAND CONTRARY TO A PROVISION, COVENANT OR CONDITION OF LEASE.

MODIFICATIONS IF APPLICABLE

APPROVED IN RESPECT OF NOMINATED AMENDMENTS No. 3-6 ONLY. ANY OTHER VARIATIONS TO THE ORIGINALLY APPROVED PLAN ARE NOT APPROVED.

- AMENDMENTS
- 1 SITING FOR EXTENSION ALTERED
 - 2 HEIGHT OF RETAINING WALL DETERMINED
- ADDITIONAL AMENDMENTS (FEB 81)
- 3 DETAIL OF STEPS
 - 4 RELOCATION OF AL. SLIDING DR.
 - 5 ROOF DETAILS & SPECIFICATIONS.
 - 6 DETAILS OF SUPPORT OF U.B.

TC 3

TITLE	PROPOSED AMENDMENT AND EXTENSION
	MR & MRS. A.I. KENNER
	29 8 GARRAN ACT
SCALES	1:100 1:500

BUILDINGS (DESIGN AND SITING) ORDINANCE 1964 AS AMENDED APPROVAL GRANTED

1-3 MAY 1981

DELEGATE NATIONAL CAPITAL DEVELOPMENT COMMISSION

IN RESPECT OF NOMINATED AMENDMENTS ONLY

APPROVED FOR CONSTRUCTION BY THE HOLDER OF A CLASS "A" LICENCE.

CLASS OF OCCUPANCY: RESIDENCE I OUTBUILDINGS X

14 MAY 1981

DEPUTY BUILDING CONTROLLER

ALL WORK TO CONFORM TO BMACT AND RELAVENT S.A.A. CODES

DESIGNED

MOORE & SMITH PLUMBING & DRAINAGE CONSULTANTS Unit 1, Melongio Mall, Epswich Telephone 805 226

SCALE



Department of the Capital Territory
POST OFFICE BOX 158, CANBERRA CITY, ACT 2601

BUILDING SECTION
North Building, Civic Offices,
London Circuit, 491655

Received Building Section
20 OCT 1981

Dept. of the Capital Territory

123

12201081Z=0090

ISSUED BY

APPLICATION FOR APPROVAL OF PLANS

BL 1/6(2/81)

		Cash Register Imprint	
Name of Applicant MOORE & SMITH P/L Shop 1, Molonglo Mall FYSHWICK A.C.T. 2609 PH. (062) 80 5226		Address MOORE & SMITH P/L Shop 1, Molonglo Mall FYSHWICK A.C.T. 2609 PH. (062) 80 5226	
Name of lessee / owner of parcel of land <i>Mr & Mrs A. I. Kerner</i>		Address (show Box No. if any) MOORE & SMITH P/L Shop 1, Molonglo Mall FYSHWICK A.C.T. 2609 PH. (062) 80 5226	
Description of the building work <i>Amendments to proposed additions</i>			
Description of land on which the building work is to be carried out	Block <i>29</i>	Section <i>B</i>	Division (Suburb) <i>Canberra</i>
To be specified in accordance with the appropriate classification in the Building Manual.	Type of construction <i>(N/A for Class I or X buildings)</i>		Cost <i>\$2,000</i>
	Class of occupancy		Total floor area where applicable
This application is for: (please tick appropriate box) <input type="checkbox"/> New work <input checked="" type="checkbox"/> Amendment to approved plan <input type="checkbox"/> Amendment to plan not yet approved <input type="checkbox"/> Details			
<i>I hereby apply for approval of the attached plans, and request that approved plans be -</i> <input type="checkbox"/> posted to the applicant's address <input type="checkbox"/> held at the counter for collection (telephone advice will be given when ready for collection)			
To be completed if application made otherwise than by the lessee / owner, his solicitor or architect.		<i>I hereby authorise the abovenamed applicant of the address indicated to make this application on my behalf</i> <i>[Signature]</i> <i>4.10.79</i> signature of lessee / owner date	

FOR OFFICE USE ONLY	<input type="checkbox"/> New work	Plans numbered <i>13330/K</i>	Class of licence required
	<input checked="" type="checkbox"/> Amendment to approved plan	Area <i>(1-9)</i>	Valuation <i>\$15,000</i>
	<input type="checkbox"/> Amendment to plan not yet approved	<p style="text-align: center; color: red; font-weight: bold;">APPROVED IN RESPECT OF NOMINATED AMENDMENTS No. 1-9 ONLY. ANY OTHER VARIATIONS TO THE ORIGINAL APPROVED PLAN ARE NOT APPROVED.</p>	
	<input type="checkbox"/> Details		
Notify applicant new permit required endorse existing permit	Plans <input checked="" type="checkbox"/> Approved <input type="checkbox"/> Not approved <i>[Signature]</i> <i>19.11.79</i> Deputy Building Controller date		
Permit fee required	Page 72 of 99		



28

Permit No.	Date of Issue	Block	Section	Suburb
166866	23 8 84	29		8 GARRAN

THIS PERMIT WILL LAPSE

115 months after date of issue unless otherwise extended by the Building Controller. Application for extension must be made before permit lapses and extension fee paid otherwise a new permit is necessary and full permit fee payable. If work is not commenced no refund is payable unless permit is surrendered before it lapses.

ISSUED TO:

Permit Holder Details

Initials	Surname
F	SCHINZINGER S32

Address

30 NARDOO CRES
O'CONNOR 2601

Nominee (if applicable)

Initials	Surname

CLASS OF BUILDERS LICENCE

B

Plan No.

13330 HK

Register Folio No.

0747

Cost \$

1000

Code No.

Description of Work

Type of Building Construction

COMPLETION OF 2 STOREY EXTENSION TO RESIDENCE

Class of Occupancy

ENDORSEMENTS Under Section 36

Inspections—Each stage specified overleaf which applies to the building work must be inspected before proceeding beyond that stage. Stages may be groups as indicated overleaf.

NO SURVEY CERTIFICATE REQUIRED.

LESSEE/BUILDER RESPONSIBLE FOR CORRECT SITING

The building work shall be carried out in accordance with the approved plans, the Building Manual A.C.T., the notations made on the plans and subject to the provisions of the Building Ordinance 1972. The approval of plans or the grant of a building permit does not affect the operation of any other law in the Territory nor does it authorise the use of the land contrary to a provision, covenant or condition of the Crown Lease.

[Signature]

512

SPECIFICATIONS 13334 PARTS

- 5 - ROOF TRUSSES
- RAFTERS: 150 x 50 450 C/C
- C JOISTS: 150 x 50
- PROPS: 150 x 50
- RIDGE: 200 x 38
- W. PLATES: 100 x 50
- FACIA B: 185 x 32

CEILING TO MATCH EXIST.
OREGON FACIA BOARD
HARDWOOD: REMAINING PARTS.

- 3 - STAIRCASE
TO BE DONE IN ACCORDANCE
WITH THE B.M.A.C.T.

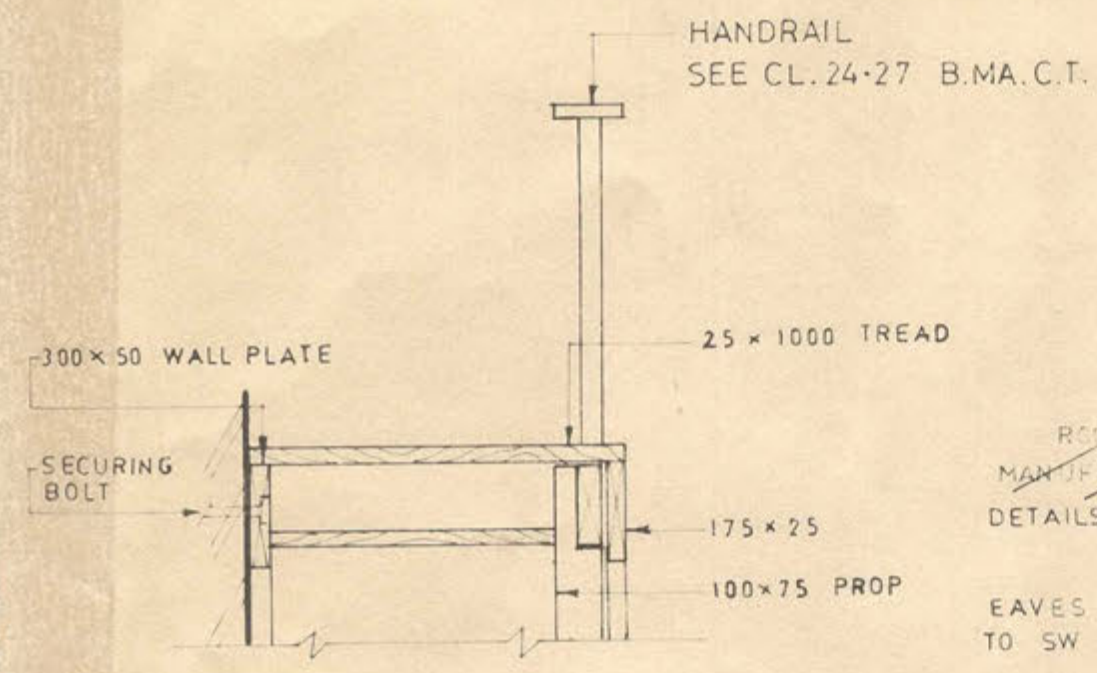

SECTION THROUGH STAIRS 1:2.0

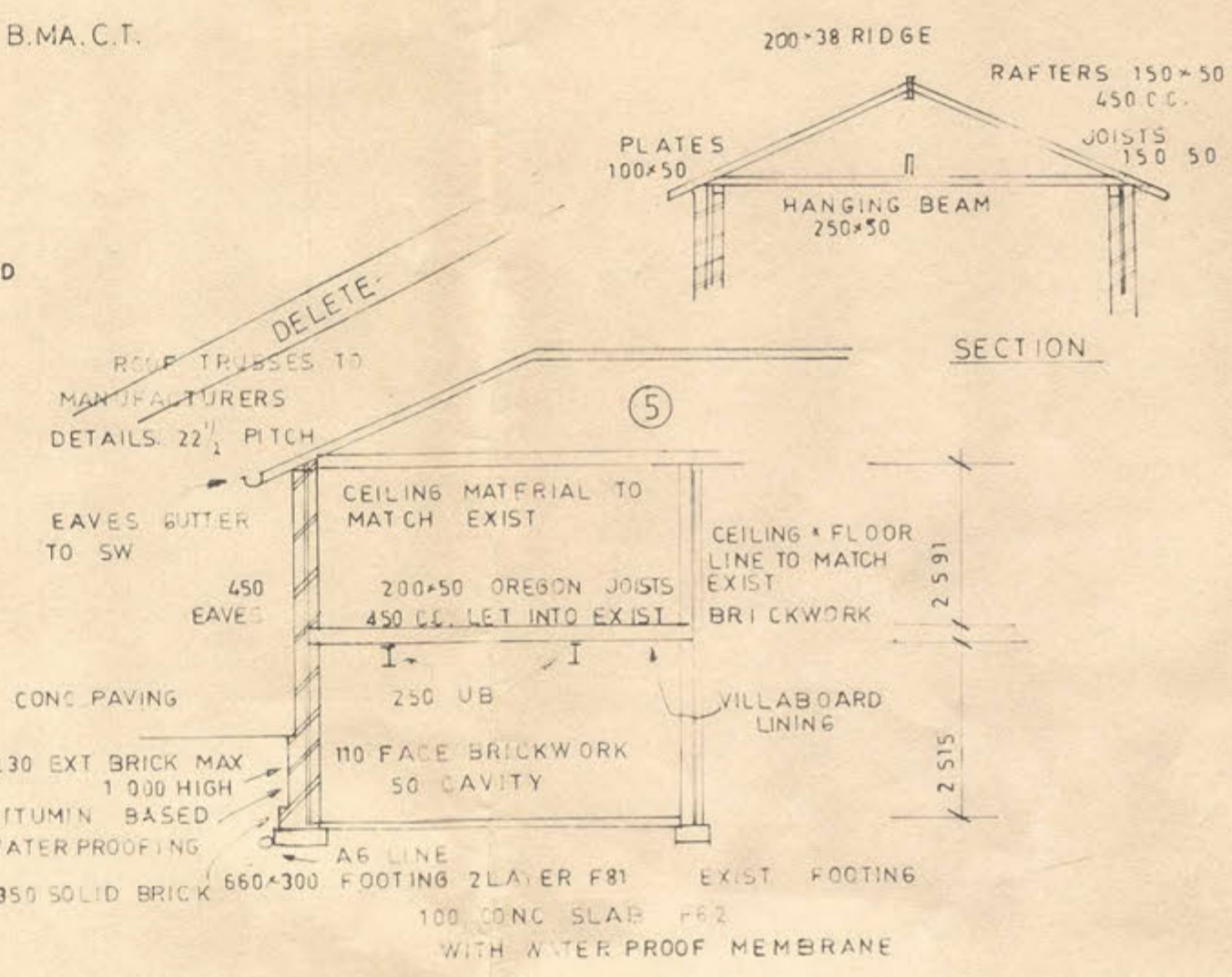

SECTION

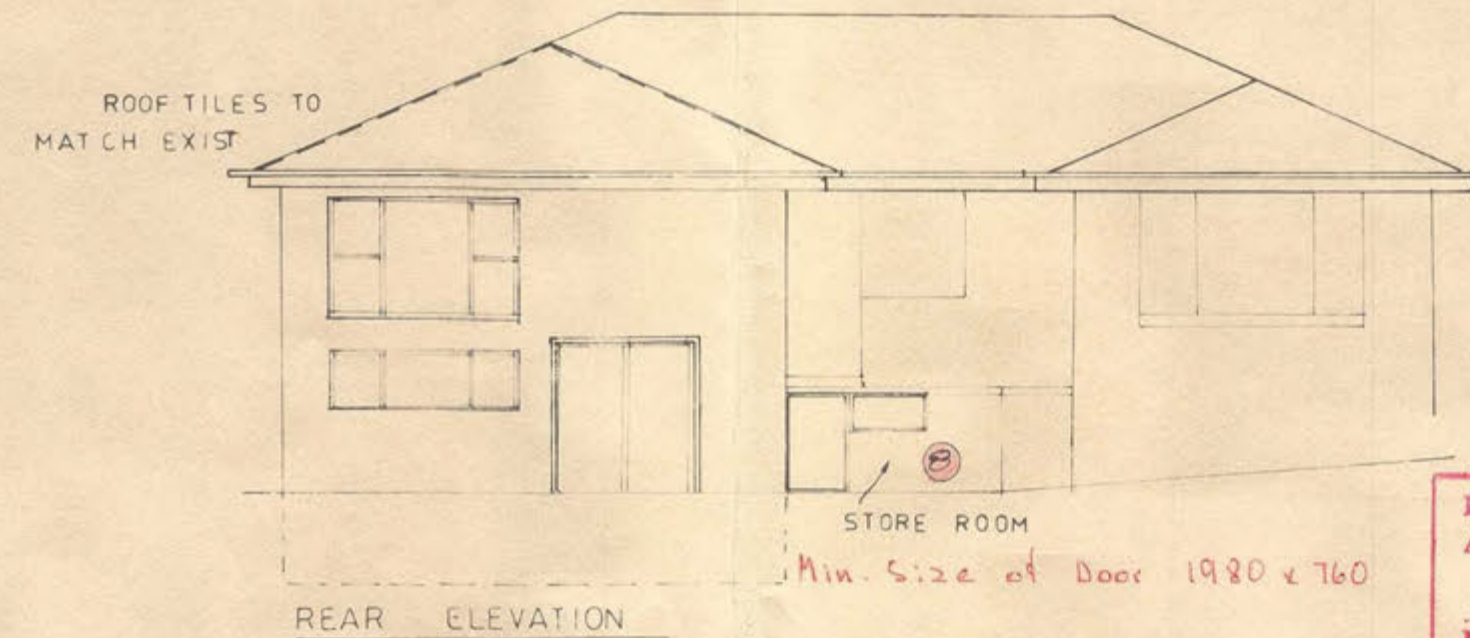

REAR ELEVATION

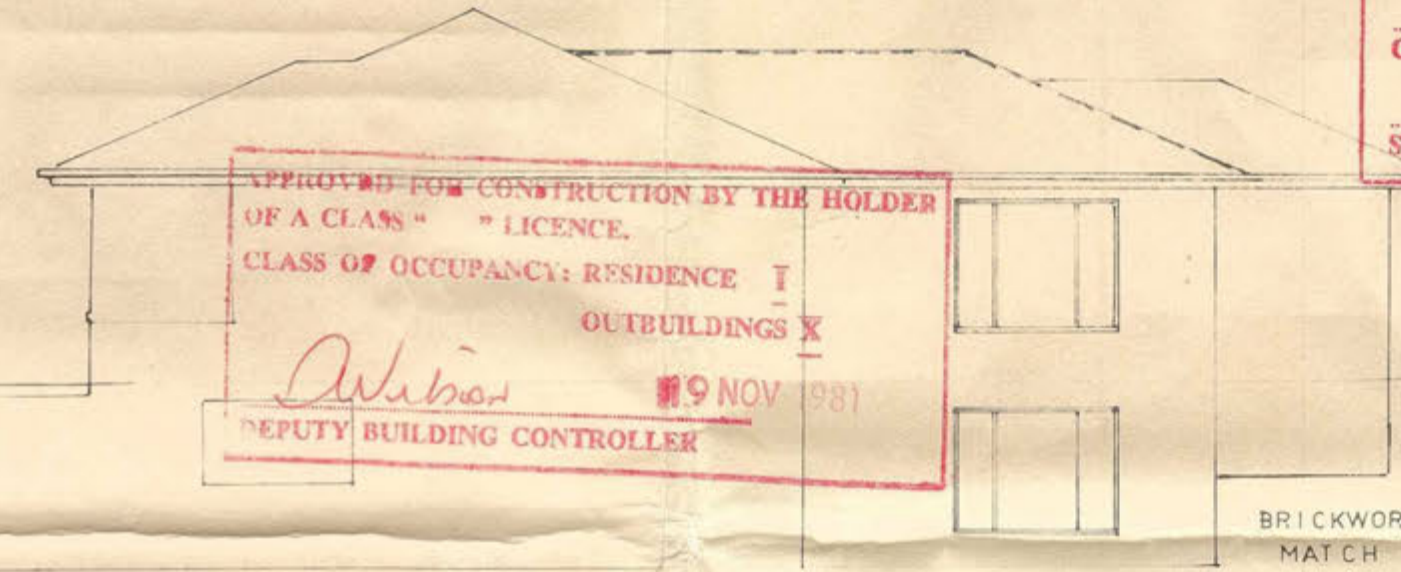

SIDE ELEVATION

APPROVED FOR CONSTRUCTION BY THE HOLDER
OF A CLASS " " LICENCE.
CLASS OF OCCUPANCY: RESIDENCE I
OUTBUILDINGS X
19 NOV 1981
DEPUTY BUILDING CONTROLLER

PLANS AND SPECIFICATIONS EXAMINED
AND RECOMMENDED FOR APPROVAL BY
ENGINEER FOR WATER SUPPLY AND SEWERAGE / /19
CHIEF ELECTRICAL ENGINEER / /19
STRUCTURAL ENGINEER 18/11/19

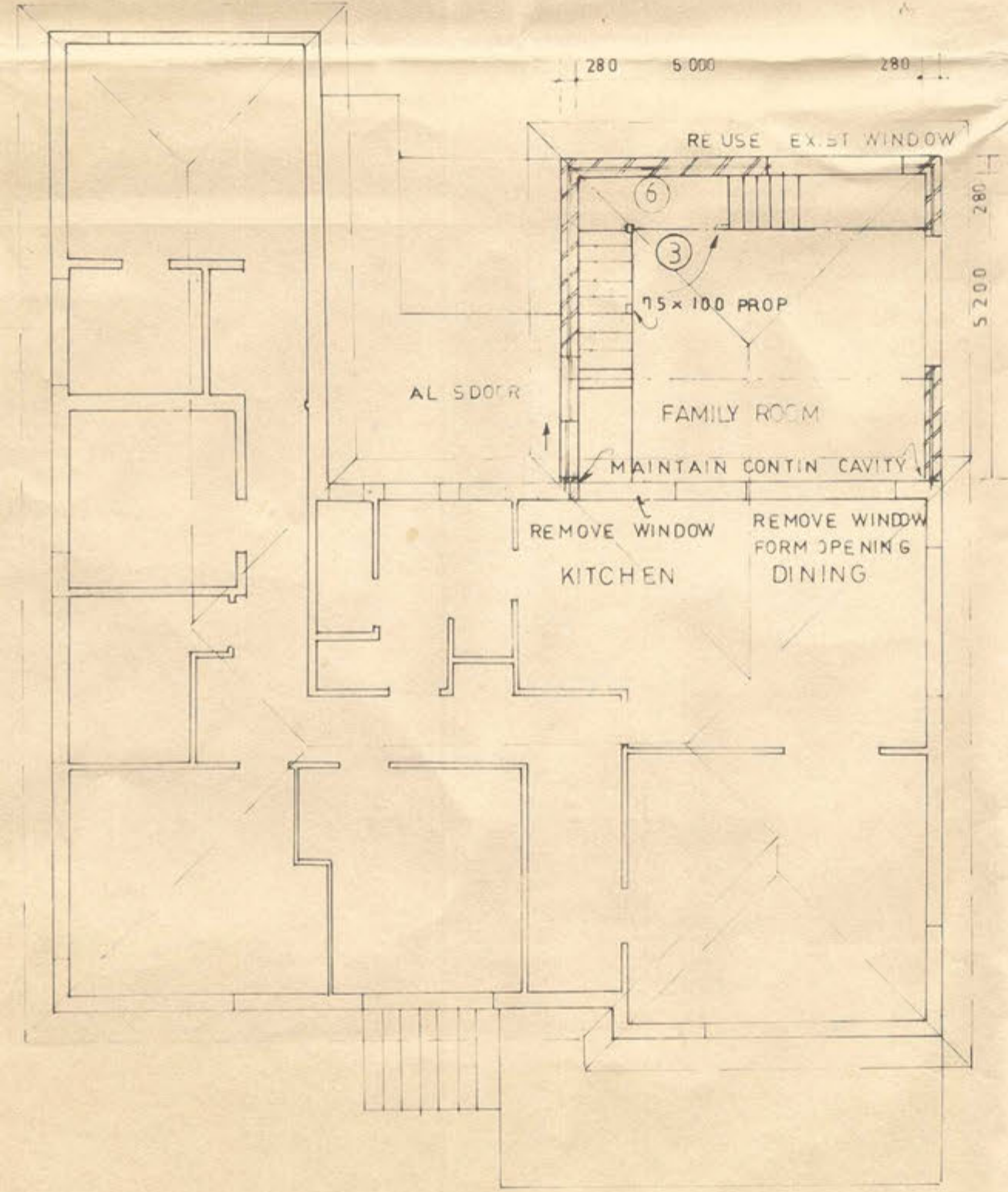

PLAN UPPER LEVEL

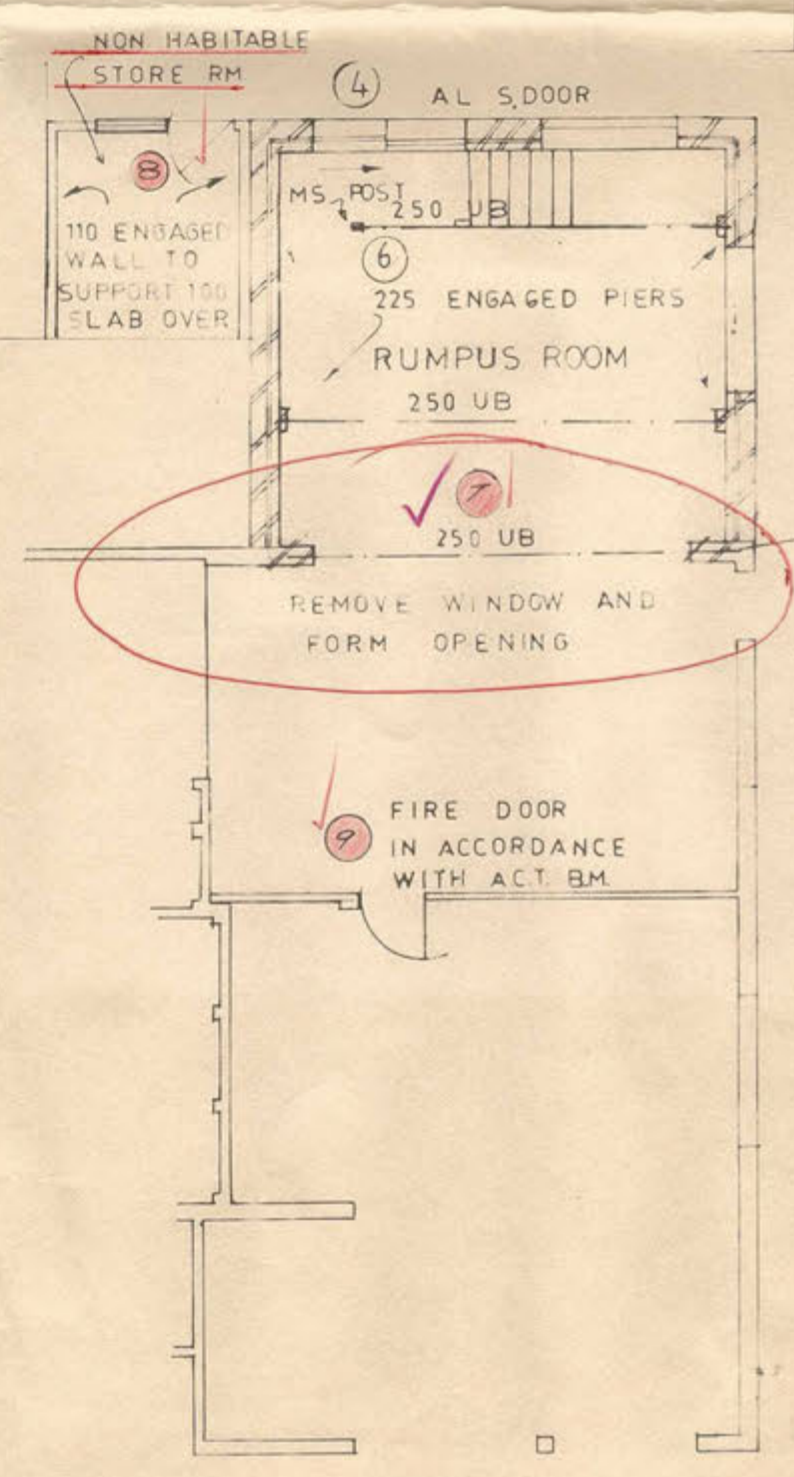

PLAN LOWER LEVEL

BUILDINGS (DESIGN AND SITING)
ORDINANCE 1984 AS AMENDED
APPROVAL GRANTED IN RESPECT OF NOMINATED
AMENDMENTS ONLY
29 OCT 1981
DELEGATE
NATIONAL CAPITAL
DEVELOPMENT COMMISSION

- SITE PLAN LEVELS
- UPPER LEVEL 0.0
 - GL A & B -4.031
 - LOWER FL A & B -5.331
 - GL C -5.381

SITE PLAN

APPROVED IN RESPECT OF NOMINATED
AMENDMENTS No's (1-9) ONLY. ANY OTHER
VARIATIONS TO THE ORIGINALLY APPROVED
PLAN ARE NOT APPROVED.

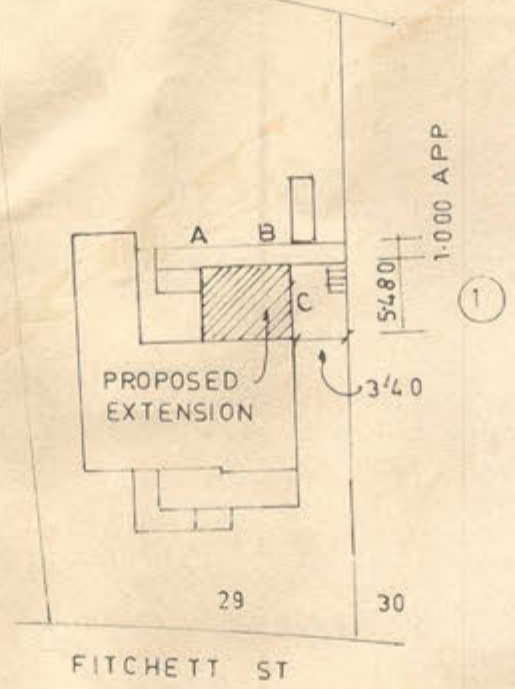

ALL WORK TO CONFORM WITH BM ACT &
RELAVENT SSA CODES

TC 3

TITLE
PROPOSED AMENDMENT AND EXTENSION
MR & MRS. A.I. KENNER
29 8 GARRAN ACT
SCALES 1:100 1:500

AMENDMENTS 13/10/81

- 7 DELETE LOAD BEARING WALL
- 8 NON HABITABLE STORE ROOM
- 9 FIRE DOOR IN ACCORDANCE WITH BM ACT.

BUILDING WORK SHALL BE CONSTRUCTED IN ACCORDANCE WITH THE APPROVED PLANS THE BUILDING MANUAL ACT, THE NOTATIONS MADE ON THE PLANS AND ANY MATTERS SPECIFIED ON THE BUILDING PERMIT. THE APPROVAL OF PLANS OR THE GRANT OF A BUILDING PERMIT DOES NOT AFFECT THE OPERATION OF ANY OTHER LAW IN THE TERRITORY, NOR DOES IT AUTHORISE THE USE OF THE LAND CONTRARY TO A PROVISION, COVENANT OR CONDITION OF LEASE.

DESIGNED
MOORE & SMITH PLU
PLUMBING & DRAINAGE CONSULTANTS
Unit 1, Melbourne Mall, Fishwick
Telaphona 805 226.

SCALE

6 DETAILS OF SUPPORT OF U.B.

APPROVED IN RESPECT OF NOMINATED AMENDMENTS No's 1-9 ONLY. ANY OTHER VARIATIONS TO THE ORIGINALLY APPROVED PLAN ARE NOT APPROVED.

PLANS/FILE No. 13330/K
Received Building Section
20 OCT 1981
Dept. of the Capital Territory

- AMENDMENTS 13 10 81
- 1 WINDOW RELOCATED
 - 2 SHOWER AND WC REVERSED
 - 3 EXTEND BBQ AREA
 - 4 100 x 50 HW JOIST @ 450 cc
 - 5 150 x 50 HW BEAM
 - 6 50 Ø PIPE TO TAKE BEAM

LIGHT & VENTILATION TO ACT. BM

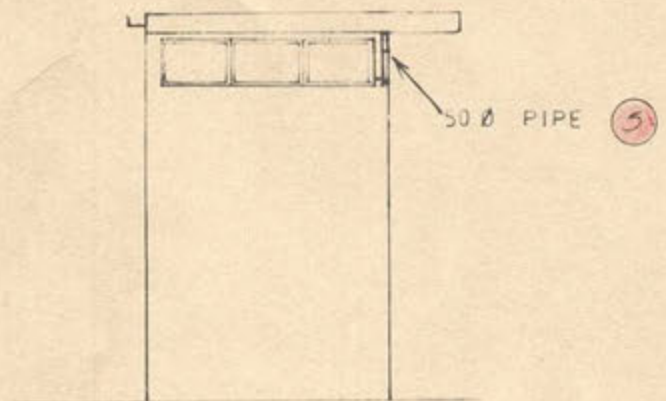

ELEVATION 'A'

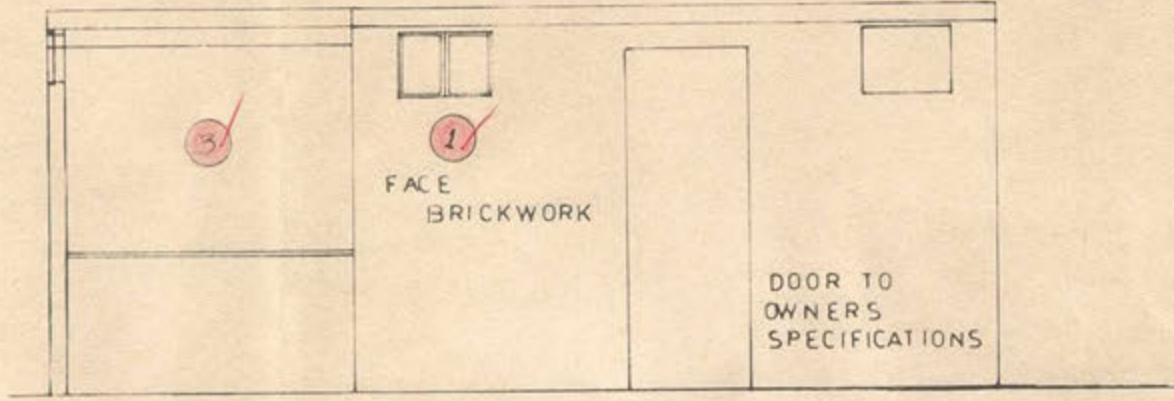

ELEVATION 'C'

APPROVED FOR CONSTRUCTION BY THE HOLDER OF A CLASS " " LICENCE.
CLASS OF OCCUPANCY: RESIDENCE I
OUTBUILDINGS X
Wilson
19 NOV 1981
DEPUTY BUILDING CONTROLLER

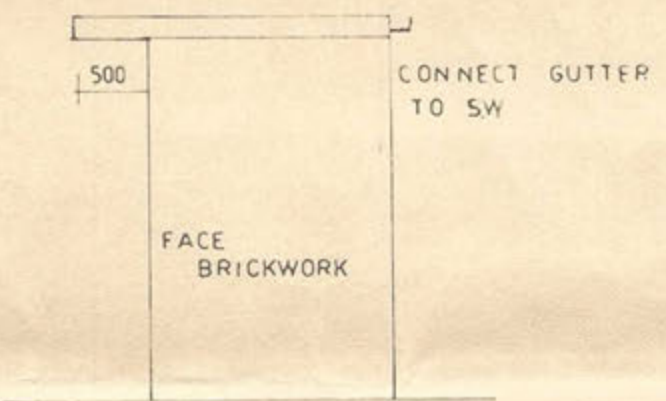

ELEVATION 'B'

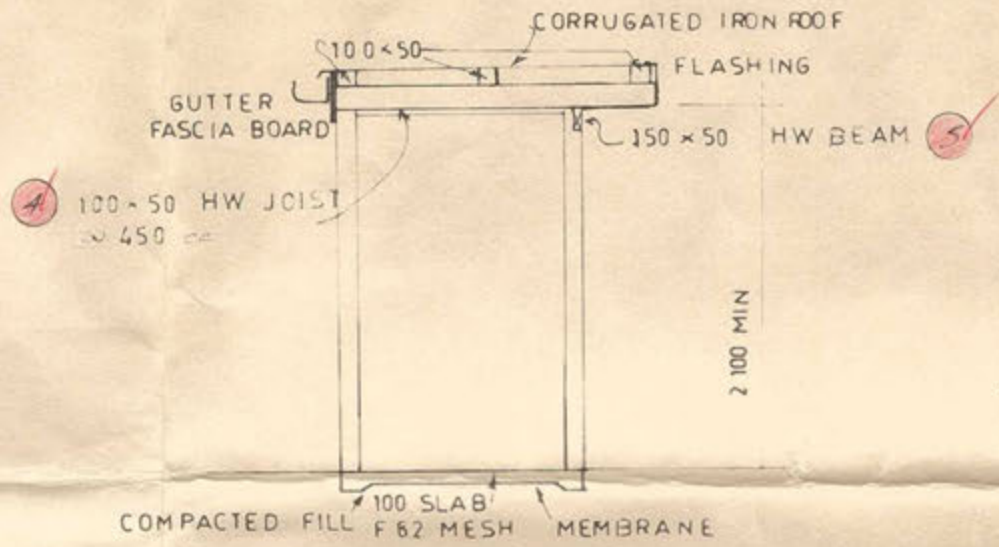

SECTION

BUILDINGS (DESIGN AND SITING) ORDINANCE 1964 AS AMENDED
APPROVAL GRANTED IN RESPECT OF NOMINATED AMENDMENTS ONLY
29 OCT 1981
DELEGATE *M. Stubbs*
NATIONAL CAPITAL DEVELOPMENT COMMISSION

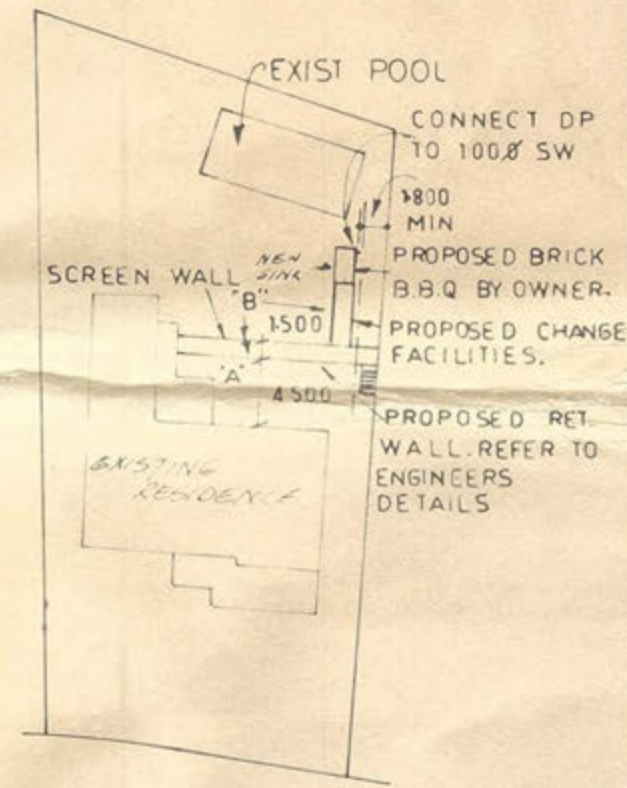

SITE PLAN

RL 'A' 0.00
RL 'B' 1.00

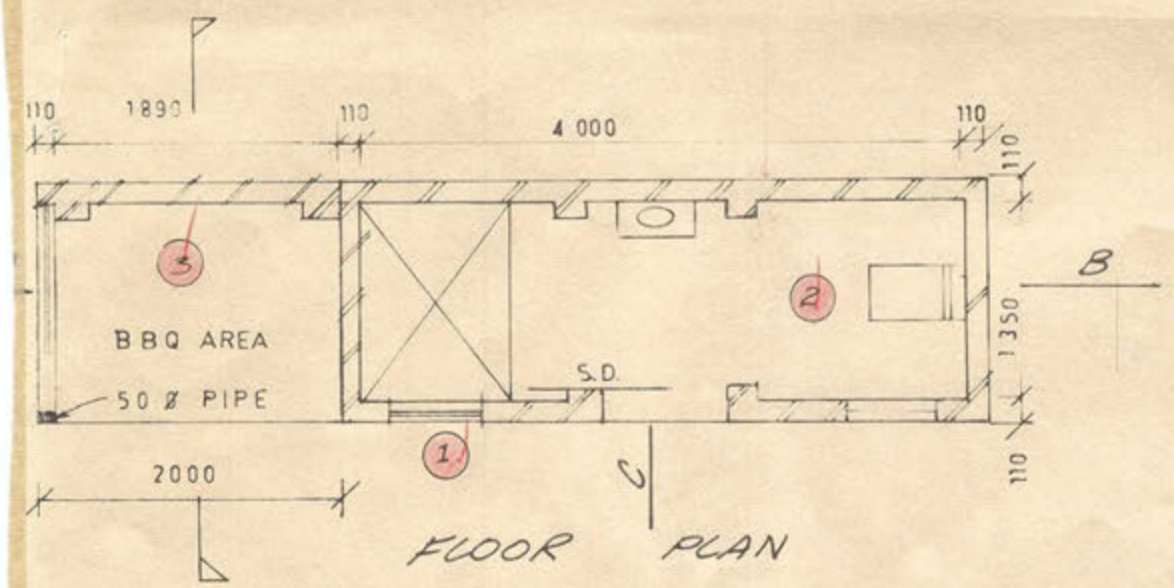

FLOOR PLAN

ALL WORK TO CONFORM TO BMACT AND RELAVENT SAA CODES
THIS PLAN TO BE READ IN CONJUNCTION WITH ENGINEERING DETAILS FOR SCREEN WALL AND RETAINING WALL.

AMENDED PLAN 13 10 81
PROPOSED ADDITIONS:
MR & MRS A.I. KENNER
BLOCK: 29, SECTION: 8, GARRAM
DESIGN: MOORE & SMITH PTY LTD
PLUMBING & DRAINAGE CONSULTANTS. PH 805 226
SCALES: 1:500
1:50
DWG. No. D45/MS1



Department of the Capital Territory
 POST OFFICE BOX 158, CANBERRA CITY, ACT 2601
 BUILDING SECTION
 North Building, Civic Offices,
 London Circuit, 491355



APPLICATION FOR APPROVAL OF PLANS

BL 1/6(2/81)

Cash Register Imprint

Name of Applicant F. Schinzinget	Address 30 Nardoo Creek Connor
	Phone 479036 Postcode 2601

Name of lessee / owner of parcel of land A.I. Kennet	Address (show P.O. Box No. if any) 97 Fitchett St., Gattan
	Phone 814405 Postcode 2605

Description of the building work
Pergola

Description of land on which the building work is to be carried out	Block 29	Section 8	Division (Suburb) Gattan
---	--------------------	---------------------	------------------------------------

To be specified in accordance with the appropriate classification in the Building Manual.	Type of construction <i>(N/A for Class I or X buildings)</i>	Cost 900,-
	Class of occupancy -	Total floor area where applicable -

This application is for:
 (please tick appropriate box)

New work Amendment to approved plan Amendment to plan not yet approved Details

I hereby apply for approval of the attached plans, and request that approved plans be -

posted to the applicant's address *[Signature]* **17.9.84**
signature of applicant date

held at the counter for collection (telephone advice will be given when ready for collection)

To be completed if application made otherwise than by the lessee / owner, his solicitor or architect.

I hereby authorise the abovenamed applicant of the address indicated to make this application on my behalf

[Signature] **17.9.84**
signature of lessee / owner date

FOR OFFICE USE ONLY	<input checked="" type="checkbox"/> New work	Plans numbered 13330/L	Class of licence required C
	<input type="checkbox"/> Amendment to approved plan	Area	Valuation
	<input type="checkbox"/> Amendment to plan not yet approved	Total fees payable 15-00	
	<input type="checkbox"/> Details	Plans	
	<input checked="" type="checkbox"/> Notify applicant <input checked="" type="checkbox"/> new permit required <input type="checkbox"/> endorse existing permit <input type="checkbox"/> Permit fee required	<input checked="" type="checkbox"/> Approved <input type="checkbox"/> Not approved <i>[Signature]</i> OCT. 11 1984 <small>Deputy Building Controller date</small>	

NO SURVEY CERTIFICATE REQUIRED. LEASER/BUILDER RESPONSIBLE FOR CORRECT SITING



Building Ordinance 1972 PERMIT TO CARRY OUT BUILDING WORK

Part (III)

BL 1/9 (3/84)

Permit No.	Date of Issue	Block	Section	Suburb
68237	171084	129	113	Gaman

THIS PERMIT WILL LAPSE

15 months after date of issue unless otherwise extended by the Building Controller. Application for extension must be made before permit lapses and extension fee paid otherwise a new permit is necessary and full permit fee payable. If work is not commenced no refund is payable unless permit is surrendered before it lapses.

ISSUED TO:

Permit Holder Details

Initials	Surname
F	Schinzinger 5.342

Address

30 Nardoo Crescent,
O'Connor 2601

Telephone: H B

Nominee (if applicable)

Initials	Surname

CLASS OF BUILDERS LICENCE

13

Plan No.

1133302

Register Folio No.

10747

Cost \$

900

Code No. Description of Work

Pergola

Type of Building Construction

11

Class of Occupancy

1

ENDORSEMENTS Under Section 36

Inspections—Each stage specified overleaf which applies to the building work must be inspected before proceeding beyond that stage. Stages may be groups as indicated overleaf.

"NO SURVEY CERTIFICATE REQUIRED."
 LESSEES/BUILDER RESPONSIBLE FOR CORRECT SITING

The building work shall be carried out in accordance with the approved plans, the A.C.T. Building Manual the notations made on the plans and subject to the provisions of the Building Ordinance 1972. The approval of plans or the grant of a building permit does not affect the operation of any other law in the Territory nor does it authorise the use of the land contrary to a provision, covenant or condition of the Crown Lease.

Deputy Building Controller



INSPECTION RECORD

No. 127456

Permit Holder: *F. SCHINZINGER*

Block: *29*

Section: *8*

Suburb: *GARRAN*

Stage:

PERGOLA FINAL

A brief inspection of parts of the construction on this site has indicated that:

Work may proceed to next stage
 may not proceed to next stage

The following matters appear to require your attention

Please arrange access

Please rebook this inspection stage when rectified

Posted

Left on site

P. Davis 8.1.85
Building Inspector



Certificate of Occupancy and Use

Certificate No.: **B20215391C1**

**Access Canberra Land, Planning and
Building Services**

ABN 16 479 763 216
8 Darling Street Mitchell
GPO Box 158 ACT 2601
www.act.gov.au/accesscbr

This Certificate is issued in accordance with Section 69 (2) of the Building Act 2004.

The building work listed on this certificate has been completed substantially in accordance with the prescribed requirements and is considered fit for occupation and use.

Unit	Block	Section	Division (Suburb)	District	Jurisdiction
	29	8	GARRAN	WODEN VALLEY	Australian Capital Territory

Plans
B20215391/A

Building Works

Class of Occupancy	Nature of Work	Project Item Description	Other Description	Type Of Const.	Unit	BCN ID	Builder
10b	Other	DA EXEMPT- SEE DESCRIPTION	installation of solid burning fuel appliance	NA		B20215391N1	THINK MAKE ENJOY PTY LTD

Comments

Important Note:

The issue, under this Part, of a certificate in respect of a building or portion of a building does not affect the liability of a person to comply with the provisions of a law of the territory (including this Act) relating to the building or portion of the building.

Issued by: Sian OSullivan

Issued on: 19/07/2022

Delegate of the ACT Construction
Occupations Registrar.

ACTmapi

Site Plan
Garran
Block 29
Section 8

Notes:

97 Fitchett St



BUILDING APPROVAL
issued under s 28 of the
Building Act 2004

Issue date 26/10/2021.....

Stephen S Kolano

[Signature]
Certifier signature

BCA Occupancy Class:
.....10b.....
BCA Type of Construction:
N/A.....

1: 500



21-Oct-2021 Page 1 of 1

DISCLAIMER

The map is a user generated static output from an Internet mapping site and is for reference only. Data layers that appear on this map may or may not be accurate, current or otherwise reliable.



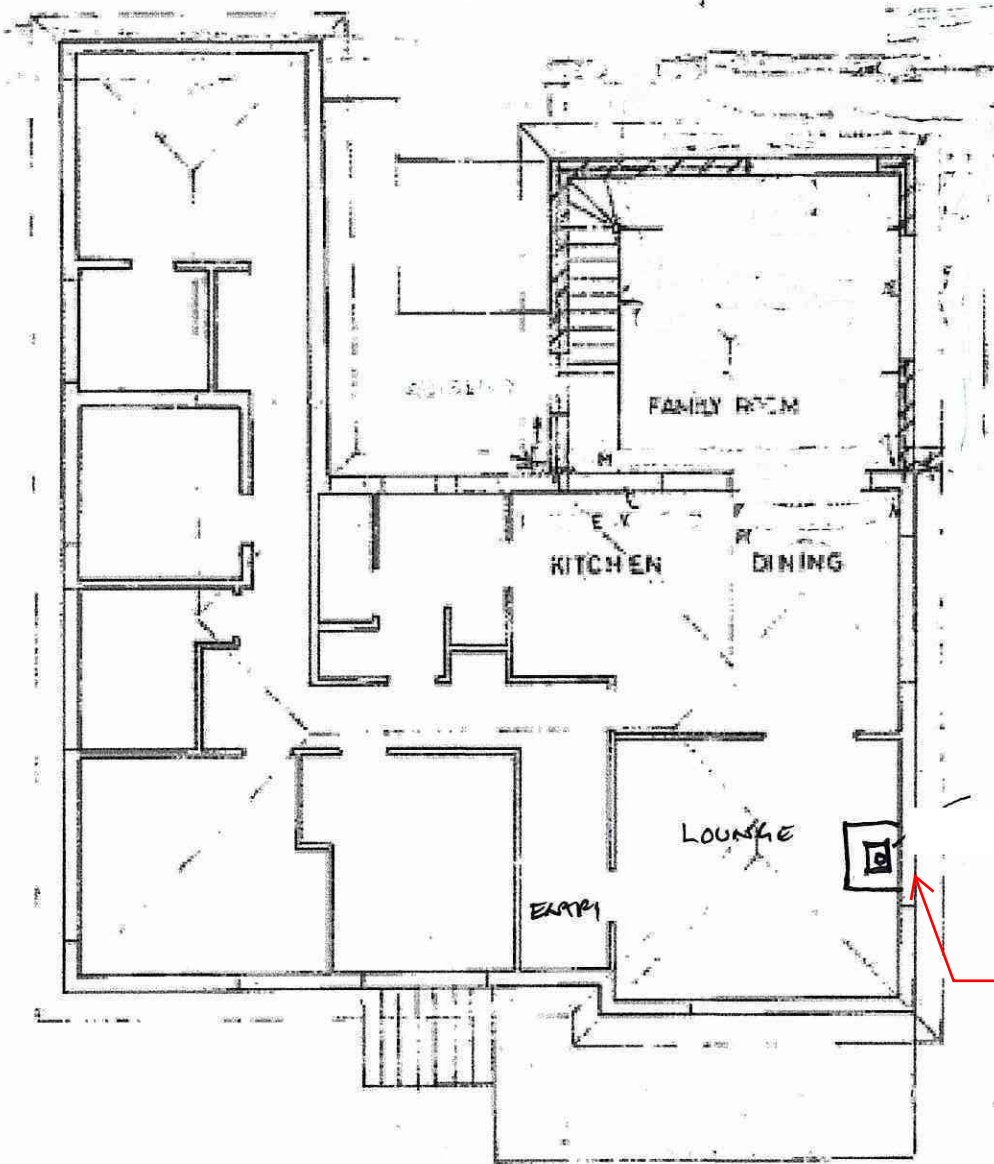

AUSCERT
 BUILDING CERTIFIERS
 ACT LIC# 2017963

BUILDING APPROVAL
 issued under s 28 of the
Building Act 2004

Issue date26/10/2021.....

Stephen S Kolano

 Certifier signature

Location of solid burning fuel appliance

FLOOR PLAN
 scale 1:100

SITE PLAN
 scale NTS

FOR CONSTRUCTION

Think Make Enjoy
Copyright © Think Make Enjoy 2021

CLIENT HUTCHISON
 ADDRESS 97 FITCHETT ST GARRAN

FIRE PLACE			
BLOCK	29	SEC.	8
DRAWING No.		DATE	REVISION
A01		15.10.21	0'

PLAN OF SANITARY DRAINAGE FOR

Owner *MR. & MRS. A. I. KENNER.*

LOT 29

SECTION B.

DISTRICT *GARRAN.*

A.C.T.

REFERENCE

G.T. Gully Trap.

D.T. Disconnecter Trap.

G.I.T. Grease Interceptor Trap.

C.I.P. Cast Iron Pipe.

S.P.D. Stoneware Pipe Drain.

I.C. Inspection Chamber.

I.O. Inspection Opening.

E.V. Educt Vent.

S.V.P. Soil Vent Pipe.

V.P. Ventilating Pipe.

T.I.T. Triple Interceptor Trap.

Scale — 40 feet = 1 inch

All work to be executed in accordance with the Canberra Sewerage and Water Supply Regulations.

This plan to be read in conjunction with the approved architectural plans and specifications.

NOTES:—Drains to be laid shown in blue lines. Existing drains shown in green lines.

AMENDED DESIGN

FIXTURES

- No. 1. Water Closet.
- .. 2. Bath.
- .. 3. Shower.
- .. 4. Lav. Basin.
- .. 5. Sink.
- .. 6. Trough.
- .. 7. ~~Washing Machine.~~

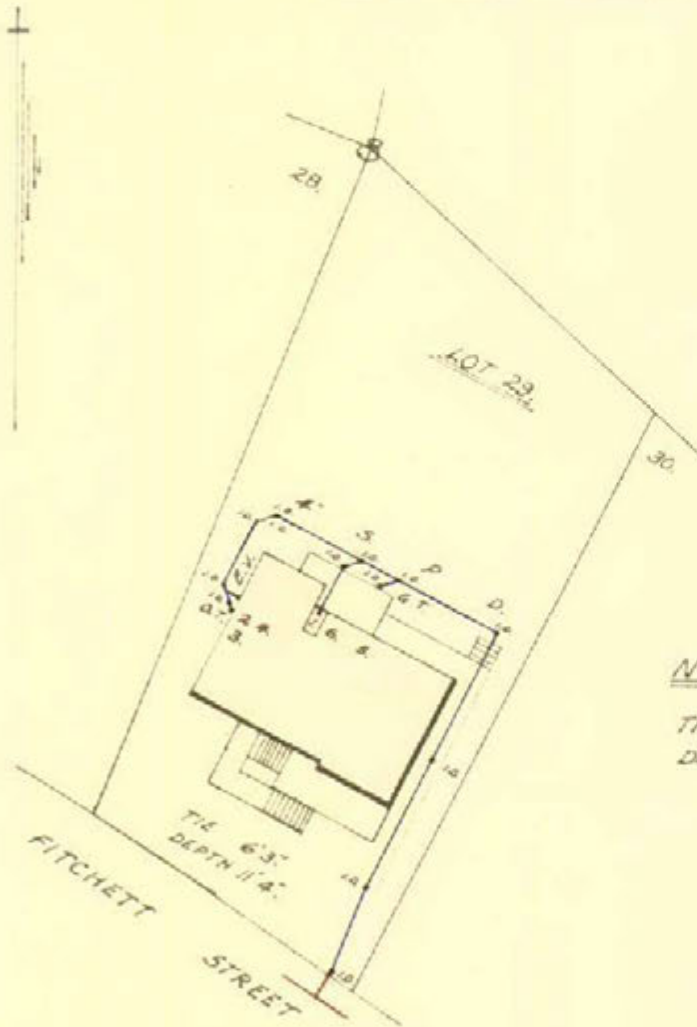

NOTE

THIS PLAN SUPERSEDES ORIGINAL PLAN DATED 28/2/1967.

INCHES

PLAN OF SANITARY DRAINAGE

DRAINAGE PLAN No 11115/A

OWNER MR. & MRS. A.I. KENNER

BLOCK 29 SECTION B GARRAN A.C.T.

REFERENCE

DT. Disconnector Trap	SPD Stoneware Pipe Drain	I.C. Inspection Chamber	FT. Floor Trap
EV. Eject Vent	CIP Cast Iron Pipe	MH Man Hole	SVP Soil Vent Pipe
GT. Gully Trap	IO Inspection Opening	VP Ventilating Pipe	VR Vertical Riser

NOTE: All work to be executed in accordance with Canberra Sewerage & Water Supply Regulations

SCALE METRIC 1:500

FIXTURES

- 1 WATER CLOSET
- 2 BATH
- 3 BASIN
- 4 SHOWER
- 5 SINK
- 6 TROUGHS

ADDITIONAL WORK.

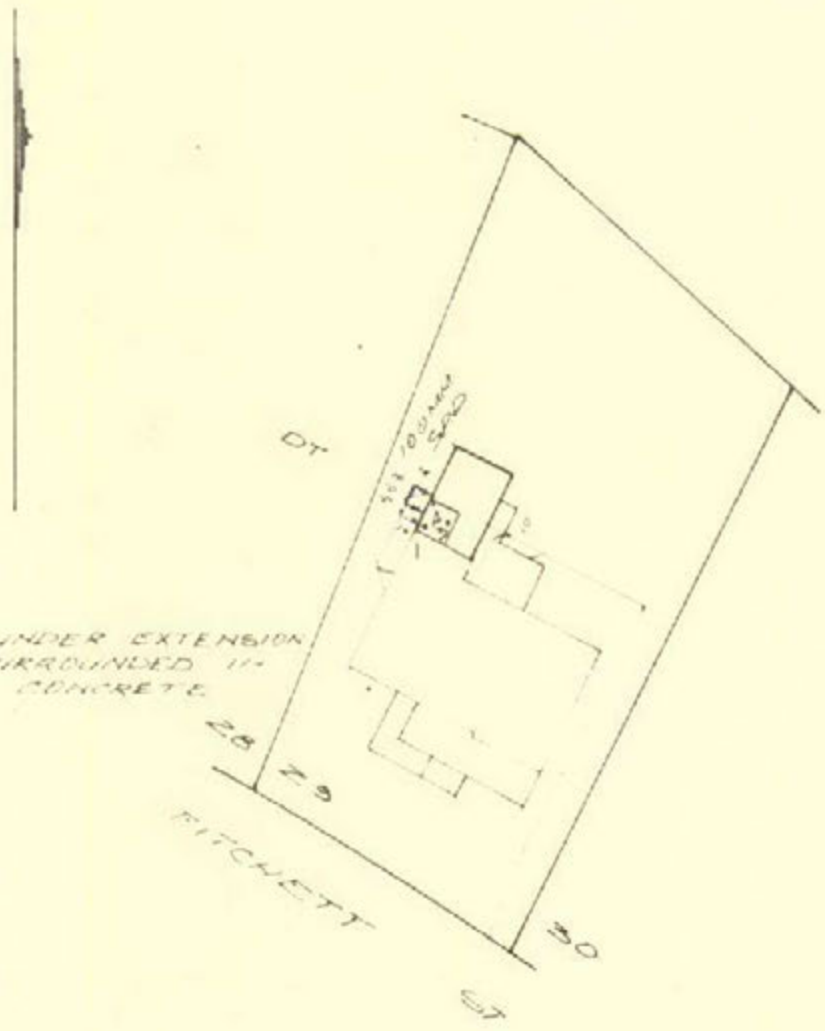

DRAINS UNDER EXTENSION TO BE SURROUNDED IN 100MM CONCRETE

NOTES DRAINS TO BE LAID ARE SHOWN IN BLUE LINES THIS PLAN TO BE READ IN CONJUNCTION WITH APPROVED ARCHITECTURAL PLANS AND SPECIFICATIONS
 DRAINS TO BE DELETED SHOWN BY RED X EXISTING DRAINS SHOWN IN GREEN LINES
 POSITION OF BRANCH TO BE LOCATED BEFORE ANY WORK IS COMMENCED

Designed by G MOORE & N SMITH Phone 95 9236 Plumbing & Drainage Consultants

DRAWN G Moore

REF J 555

H. Hillaber

18.10.74

SEWERAGE ENGINEER

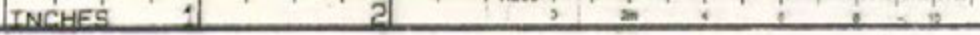

PLAN OF SANITARY DRAINAGE

DRAINAGE PLAN No 11115/C

OWNER MR + MRS A. I KENNER.

BLOCK 29 SECTION B GARRAN.

ACT

—REFERENCES—

D.T	Disconnect Trap	V.C.P	Vitrified Clay Pipe	I.C	Inspection Chamber	FT	Floor Trap
E.V	Educt Vent	C.I.P	Cast Iron Pipe	M.H.	Man Hole	S.V.P.	Soil Vent Pipe
G.T	Gully Trap	I.O	Inspection Opening	V.P.	Ventilating Pipe	VR	Vertical Riser
I.U	Jump Up	F.P	Fixed Point	E.I	Expansion Joint		

NOTE: All work to be executed in accordance with Canberra Sewerage & Water Supply Regulations

—SCALE METRIC 1:500—

ADDITIONAL WORK.
AMENDED PLAN.



—FIXTURES—

	NO	OFF
1. WATER CLOSET	(1)	
2. BATH	()	
3. BASIN	(1)	
4. SHOWER	(1)	
5. SINK	(1)	
6. TROUGHS	()	

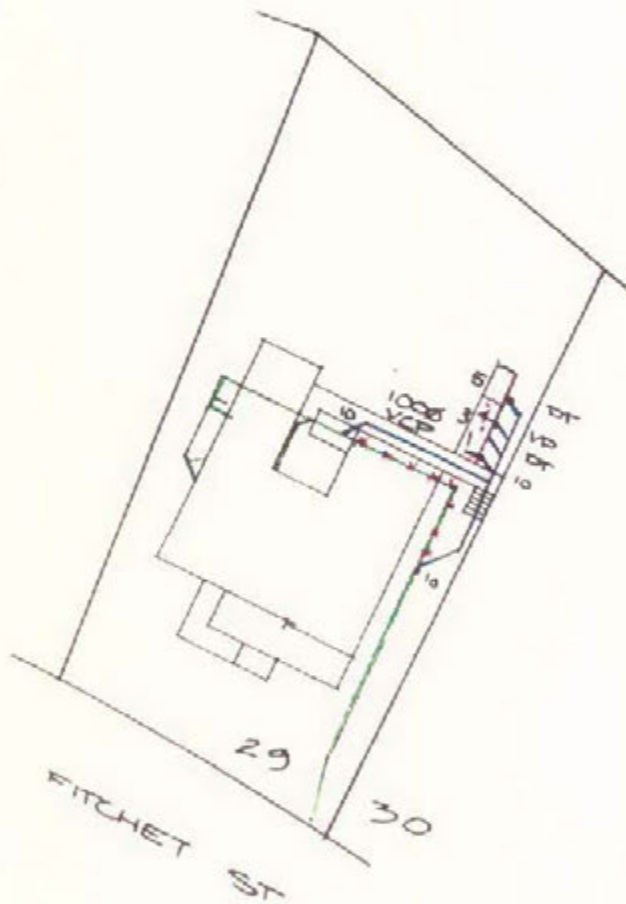

J. BURKE 25292
 PLUMBER.....
 J. BURKE 48997.
 DRAINER.....
 DRAIN INSP. 24-10-80
 FINAL INSP. 7-12-95 A.B.
 METER NO. EXISTING.....
 COMPLETION. 11/12/95

NOTES: INSPECTION OPENINGS TO BE PROVIDED AT THE TIE POSITION. ON EACH W.C. OR SLOP HOPPER BRANCH. AT INTERVALS OF NOT MORE THAN 30 METRES SPACED EQUIDISTANT WHERE POSSIBLE IMMEDIATELY UPSTREAM AND DOWNSTREAM OF JUMP-UPS
 DRAINS TO BE LAID ARE SHOWN IN BLUE LINES. THIS PLAN TO BE READ IN CONIUNCTION WITH APPROVED ARCHITECTURAL PLANS AND SPECIFICATIONS
 DRAINS TO BE DELETED SHOWN BY RED X EXISTING DRAINS SHOWN IN GREEN LINES
 POSITION OF BRANCH TO BE LOCATED BEFORE ANY WORK IS COMMENCED.
 UNPLASTICISED POLYVINYL CHLORIDE PIPE DRAINS (UPVC) INCLUDING STACKS TO BE CONSTRUCTION IN ACCORDANCE WITH AS CA67 1972 AS CA69 1972 AS 2032 1977 AND CANBERRA CODES OF PRACTICE VITRIFIED CLAY PIPES (V.C.P.) TO BE INSTALLED IN ACCORDANCE WITH AS 1693 AND AS A164

Designed by GEOFF MOORE DESIGN P.L. 806294
Plumbing & Drainage Consultants

DRAWN 6/11/86

REF B71

Bloughan
 SEWERAGE ENGINEER 13-2-86

GENERAL NOTES

- EXISTING SEWER LINES TO BE LOCATED ON SITE PRIOR TO COMMENCEMENT OF WORK.
- ALL PLUMBING AND DRAINAGE TO BE INSTALLED IN ACCORDANCE WITH AS3500.
- ALL WORK TO BE CARRIED OUT IN ACCORDANCE WITH THE CANBERRA SEWERAGE AND WATER SUPPLY REGULATIONS.
- THIS PLAN TO BE READ IN CONJUNCTION WITH APPROVED ARCHITECTURAL PLANS AND SPECIFICATIONS.
- INSPECTION SHAFT AT PROPERTY BOUNDARY TO BE IN ACCORDANCE WITH PLUMBING NOTE No3.
- ORG LEVELS TO BE IN ACCORDANCE WITH AS3500.2.2 CLAUSE 4.6.6.6 & 4.6.6.7 & PLUMBING NOTE 22.
- UNPLASTICISED POLYVINYL CHLORIDE PIPE DRAINS (UPVC) TO BE CONSTRUCTED IN ACCORDANCE WITH AS2032 AND THE CANBERRA SEWERAGE AND WATER SUPPLY REGULATIONS.
- TEMPERED HOT WATER REQUIRED AT ALL ABLUTION FIXTURES.
- PLUMBING AND DRAINAGE TO CONFORM TO ACTPLA PLUMBING NOTES 22 AND 23.

DOWN PIPE NOTES

- DOWNPIPES MUST BE SECURELY FIXED TO WALLS.
- THE SPACING BETWEEN DOWNPIPES MUST NOT MORE THAN 12 M.
- DOWNPIPES MUST BE FIXED AS CLOSE AS POSSIBLE TO VALLEY GITTERS AND, IF THE DOWNPIPE IS MORE THAN 1.2M FROM VALLEY, PROVISION FOR OVERFLOW MUST BE MADE.
- WHERE HIGH-FRONTED GUTTERS ARE INSTALLED, PROVISION MUST BE MADE TO AVOID ANY OVERFLOW FROM FLOWING BACK INTO ROOF OR BUILDING STRUCTURE BY INSTALLING SLOTTED GUTTERS OR THE LIKE.
- DOWNPIPES MUST-
 - BE COMPATIBLE WITH OTHER ROOFING MATERIALS USED IN THE ROOFING SYSTEM IN ACCORDANCE WITH 3.5.3(C) OF THE B.C.A
 - BE SELECTED IN ACCORDANCE WITH APPROPRIATE EAVES GUTTER SECTION AS SHOWN IN TABLE 3.5.2.2 OF THE B.C.A.

LEGEND

- SEWER MAIN
- STORMWATER MAIN
- WATER MAIN
- SEWER LINES
- EXISTING SEWER LINES
- VENT PIPE
- STORMWATER LINES
- SUB SOIL DRAINAGE
- DOMESTIC WATER
- NON-POTABLE WATER
- TRADEWASTE
- 90Ø AG LINE WITH FILTER SOCK CONNECTION TO STORMWATER DRAINAGE
- YS YARD SUMP. EXACT LOCATION TO BE DETERMINED ON SITE BY LANDSCAPE CONTRACTOR
- STREET HYDRANT
- STOP COCK
- WATER METER

REFERENCE

- AAV AIR ADMITTANCE VALVE
- BT BUCKET TRAP
- CO CLEAR OUT
- CWR/D
- DT DISCONNECTOR TRAP
- FBBV FIRE BRIGADE BOOSTER
- FHR FIRE HOSE REEL
- FW FLOOR WASTE
- GIT
- GT GRATED TRENCH
- HDPE
- HYD HYDRANT
- IO INSPECTION OPENING
- IS INSPECTION SHAFT
- O/F OVERFLOW
- ORG OVERFLOW RELIEF GULLY
- PP PROVISIONAL POINT
- SC STOP COCK
- SMH SEWER MANHOLE
- SPP SEWER PROVISIONAL POINT
- ST SILT TRAP
- SVP SOIL VENT PIPE
- TD TUNDISH
- TG TEST GATE
- TTD TRAPPED TUNDISH
- TWPP TRADEWASTE PROVISIONAL POINT
- TWVP TRADEWASTE VENT PIPE
- UPVC UNPLASTICISED POLYVINYL CHLORIDE
- VP VENT PIPE
- WM WATER METER
- WS WASTE STACK

FIXTURE TABLE

1	WC	0
2	BATH	0
3	BASIN	0
4	SHOWER	0
5	KITCHEN SINK	0
6	LAUNDRY TROUGH	1



DRAINAGE PLAN
NUMBER: 11115

BLOCK 29 SECTION 8
GARRAN ACT

PLAN OF SANITARY DRAINAGE
DESIGNED TO AS3500



[Handwritten Signature]
17-4-2026

PLUMBING PLAN APPROVED
APPROVED BY _____
REG. NUMBER _____
DATE _____

WORK AS EXECUTED		A.WARD
		0409249974
		PO BOX 4311
		HAWKER ACT 2614
A	WAE	7.4.2026
ISSUE	DESCRIPTION	DATE CHECKED

NEW WORKS
FITCHETT STREET
GARRAN ACT

OLI MCGREADY
Page 86 of 99

DESIGNED BY _____
DRAWN BY _____
AUTHORISED _____
DATE 7.4.2026

CLIENT _____

TITLE
HYDRAULIC SERVICES

SCALE
1:200@A3

JOB NO.
H01

DRAWING NO.
742026

Energy Efficiency Rating



UNDERSTANDING YOUR ENERGY EFFICIENCY RATING (EER)

An energy efficiency rating (EER) is a rating used to identify the energy efficiency of homes in the ACT.

The Civil Law (Sale of Residential Property) Act 2003 requires all homes being sold in the ACT to carry an energy efficiency rating (EER). This enables owners and buyers to compare a home's passive energy performance characteristics with others for sale in the Territory.

In the ACT, established homes are assessed using 1st generation software, and can achieve **0 to 6 stars** in the rating scheme.

Houses with a higher EER are more cost and energy efficient, use less energy for heating and cooling, generate lower greenhouse gas emissions, and are more comfortable.

What information is taken into account when assessing my homes energy efficiency?

- Layout of the home
- Construction of its roof, walls, windows, and floor
- Wall, floor, and ceiling insulations
- Orientation of windows and shading of the sun's path and local breezes
- Influence of the local climate
- Air leakages

What information is not applicable when assessing my homes energy efficiency?

- Heating and cooling
- Hot water systems
- Lighting systems and appliances
- Solar panels

How can I improve my energy efficiency rating?

Your energy efficiency report will include a list of design options (unless it's already achieved the maximum rating of 6 stars). This will outline the improvements that can be made to gain additional points and increase the overall star rating of your home.

When I built my home, I was provided with a 10-star energy rating. Why has this decreased?

The ACT Government has two software systems in place to generate energy efficiency ratings:

1. Established homes: An on site assessment using 1st generation software. A maximum of 6 stars can be achieved.
2. Brand new homes: A computer based assessment using 2nd generation software. A maximum of 10 stars can be achieved.

If you hold an energy efficiency rating that exceeds 6 stars, it is a 2nd generation EER and would have been provided when your home was brand new.

When assessing a home's energy efficiency for the purpose of sale, property inspection companies are required to use 1st generation software, which will achieve a maximum of 6 stars.

FirstRate Report

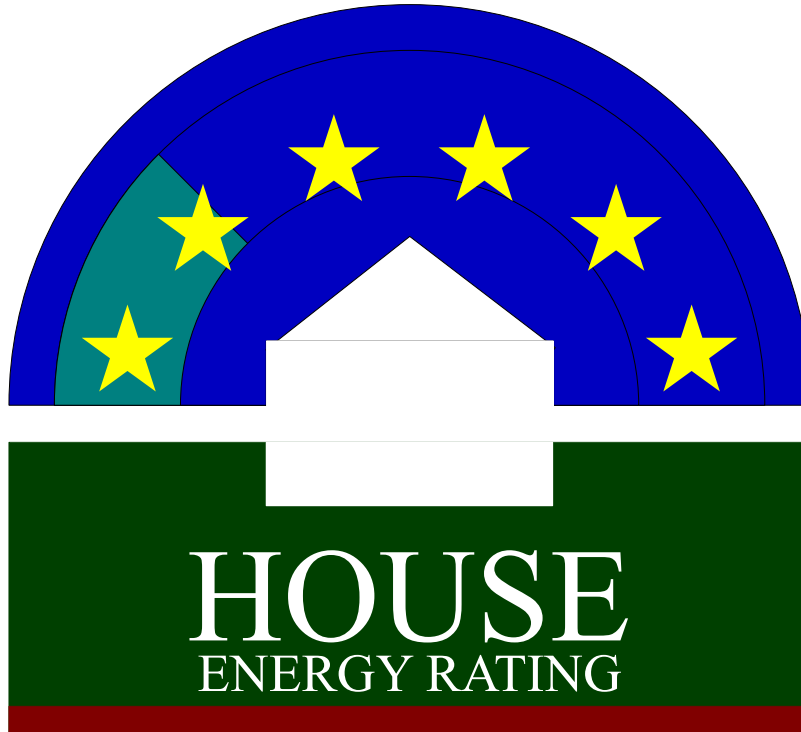

YOUR HOUSE ENERGY RATING IS: ★ ☆
in Climate: 24

1.5 STARS

SCORE: -52 POINTS

Name: Hutchinson

Ref No: 68121

House Title: Block 29 Section 8 GARRAN

Date: 07-05-2021

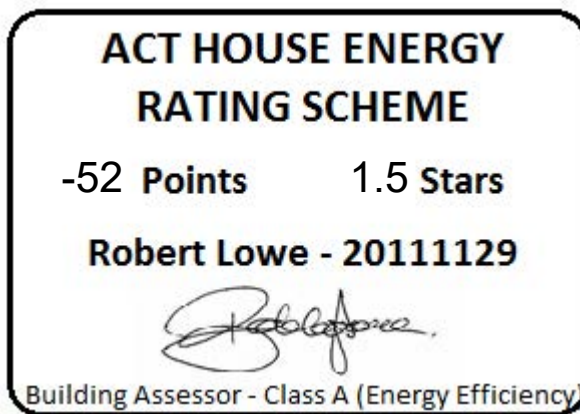

Address: 97 Fitchett Street, Garran ACT 2605



This rating only applies to the floor plan, construction details, orientation and climate as submitted and included in the attached Rating Summary. Changes to any of these could affect the rating.

IMPROVING YOUR RATING

The table below shows the current rating of your house and its potential for improvement.

Star Rating	POOR			AVERAGE				GOOD			V. GOOD	
	0 Star	★	★★	★★★	★★★★	★★★★★	★★★★★★	★★★★★★★	★★★★★★★★	★★★★★★★★★		
Point Score	-71	-70	-46	-45	-26	-25	-11	-10	4	5	16	17
Current	-52											
Potential	25											

Incorporating these design options will add the additional points required to achieve the potential rating shown in the table. Each point represents about a 1% change in energy efficiency. This list is only a guide to the range of options that could be used.

Design options

Additional points

Change added wall insulation	R 1.5	21
Change added floor insulation	R 2	7
Change glass to Double Glazing	100 %	10
Change frame to Aluminium-Improved		11
Change curtain to Heavy Drapes & Pelmet		19
Add northerly blinds	100 %	2
Seal Exhaust fans		2
Seal Internal Doors		1
Seal Gaps & Cracks		4

ORIENTATION

Orientation is one of the key factors which influences energy efficiency. This dwelling will achieve different scores and star ratings for different orientations.

Current Rating	-52	★☆☆
-----------------------	------------	------------

Largest windows in the dwelling;

Direction : North East

Area : 11 m²

The table below shows the total score for the dwelling when these windows face the direction indicated.

Note that obstructions overshadowing windows have been removed from all windows in these ratings to allow better comparisons to be made between orientations.

ORIENTATION	POINT SCORE	STAR RATING
1. North East	-51	★☆☆
2. East	-51	★☆☆
3. South East	-54	★☆☆
4. South	-55	★☆☆
5. South West	-55	★☆☆
6. West	-53	★☆☆
7. North West	-54	★☆☆
8. North	-51	★☆☆

FirstRate Mode
Climate: 24

RATING SUMMARY for: Block 29 Section 8 GARRAN, 97 Fitchett Street, Garran ACT 2605,

Assessor's Name:

Net Conditioned Floor Area: 158.3 m²

				Points		
Feature				Winter	Summer	Total
CEILING				3	1	5
Surface Area:	0	Insulation:	5			
WALL				-23	5	-18
Surface Area:	-10	Insulation:	-22	Mass:	14	
FLOOR				-3	-1	-4
Surface Area:	0	Insulation:	-4	Mass:	0	
AIR LEAKAGE (Percentage of score shown for each element)				1	0	1
Fire Place	0 %	Vented Skylights	0 %			
Fixed Vents	0 %	Windows	21 %			
Exhaust Fans	17 %	Doors	12 %			
Down Lights	0 %	Gaps (around frames)	49 %			
DESIGN FEATURES				0	1	1
Cross Ventilation	1					
ROOF GLAZING				0	-3	-3
Winter Gain	2	Winter Loss	-2			
WINDOWS				-27	-11	-37
Window Direction	Area		Point Scores			
	m2	%NCFA	Winter* Loss	Winter Gain	Summer Gain	Total
NE	13	8%	-18	17	-4	-5
SE	9	6%	-14	4	-2	-12
SW	10	6%	-16	5	-2	-13
NW	11	7%	-15	10	-2	-8
Total	43	27%	-63	36	-11	-37

* Air movement over glazing can significantly increase winter heat losses. SEAV recommends heating/cooling duct outlets be positioned to avoid air movement across glass or use deflectors to direct air away from glass.

The contribution of heavyweight materials to the window score is -2 points

			Winter	Summer	Total
RATING	★ ★	SCORE	-48	-9	-52*

* includes 4 points from Area Adjustment

Detailed House Data

House Details

ClientName Hutchinson
 HouseTitle Block 29 Section 8 GARRAN
 StreetAddress 97 Fitchett Street, Garran ACT 2605
 FileCreated 07-05-2021

Climate Details

State
 Town Canberra
 Postcode 2600
 Zone 24

Floor Details

ID	Construction	Sub Floor	Upper	Shared	Foil	Carpet	Ins RValue	Area
1	Timber	Enclosed	No	No	No	No	R0.0	60.9m ²
2	Timber	Enclosed	No	No	No	Float Timb	R0.0	24.5m ²
3	Timber	Enclosed	No	No	No	Tiles	R0.0	4.0m ²
4	Timber	Enclosed	No	No	No	Vinyl	R0.0	27.0m ²
5	Timber	Enclosed	No	No	No	Float Timb	R2.0	15.0m ²
6	Timber	Enclosed	No	No	No	Carp	R2.0	30.0m ²
7	Timber	Enclosed	No	No	No	Carp	R0.0	15.0m ²

Wall Details

ID	Construction	Shared	Ins RValue	Length	Height
1	Brick Cavity	No	R0.0	67.1m	2.4m

Ceiling Details

ID	Construction	Shared	Foil	Ins RValue	Area
1	Attic - Vented	No	No	R3.5	176.4m ²

Window Details

ID	Dir	Height	Width	Utility	Glass	Frame	Curtain	Blind	Fixed & Adj Eave	Fixed Eave	Head to Eave
1	SW	1.3m	3.1m	No	SG	ALSTD	CW	Yes	1.3m	0.5m	0.0m
2	SW	1.3m	2.1m	No	SG	ALSTD	CW	Yes	1.3m	0.5m	0.0m
3	SW	1.3m	2.6m	No	SG	ALSTD	CW	Yes	1.3m	0.5m	0.0m
4	NW	1.3m	1.1m	No	SG	ALSTD	CW	Yes	1.3m	0.5m	0.0m
5	NW	0.6m	2.6m	Yes	SG	ALSTD	NC	No	0.5m	0.5m	0.0m
6	NW	1.3m	1.9m	No	SG	ALSTD	CW	No	0.5m	0.5m	0.0m
7	NW	0.6m	1.8m	No	SG	ALSTD	NC	No	0.5m	0.5m	0.0m
8	NE	1.3m	2.6m	No	SG	ALSTD	CW	No	0.5m	0.5m	0.0m
9	SE	1.3m	1.9m	No	SG	ALSTD	CW	No	0.5m	0.5m	0.0m
10	NE	0.9m	0.7m	Yes	SG	ALSTD	NC	No	0.0m	0.0m	0.0m
11	NE	0.9m	1.1m	Yes	SG	ALSTD	NC	No	0.5m	0.5m	0.0m
12	NW	2.0m	2.1m	No	SG	ALSTD	CW	No	0.5m	0.5m	0.0m
13	NE	1.2m	3.0m	No	SG	ALSTD	CW	No	0.5m	0.5m	0.0m
14	SE	1.2m	2.1m	No	SG	ALSTD	CW	No	0.5m	0.5m	0.0m
15	SE	1.2m	2.1m	No	SG	ALSTD	CW	No	0.5m	0.5m	0.0m
16	SE	1.3m	1.4m	No	SG	ALSTD	CW	No	0.5m	0.5m	0.0m
17	NE	2.1m	2.1m	No	SG	ALSTD	CW	No	0.0m	0.0m	0.0m

Window Shading Details

Insurance Certificates & Tax Invoice



If a home was built before 1990 it may contain dangerous asbestos material

Identify where asbestos materials might be. Five common places are:



- 1.** Exterior
roof sheeting, gutters, downpipes,
ridge capping, eaves, cladding,
electrical switchboards



- 5.** Building cavities
A small number of homes may still contain
loose fill asbestos insulation in the roof
cavity, wall cavities or sub-floor space

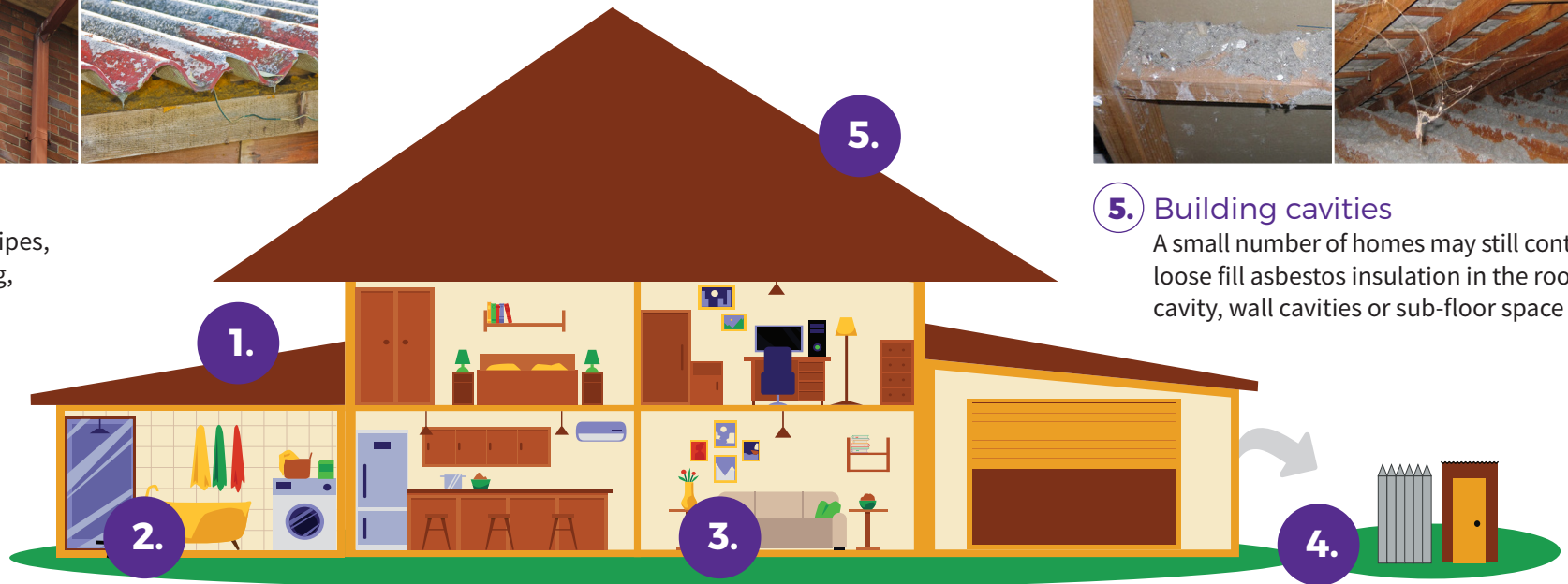

- 2.** Wet areas - bathroom, laundry and kitchen
wall and ceiling panels, vinyl floor tiles, backing for wall tiles
and splashbacks, hot water pipe insulation



- 3.** Internal areas
wall and ceiling panels, carpet underlay,
textured panels, insulation in domestic
heaters



- 4.** Backyard
fences, sheds, garages, carports, dog kennels, buried or
dumped waste, letterboxes, swimming pools

If a home was built before 1990 it may contain dangerous asbestos material

Assess the risk

A licensed asbestos assessor can help identify asbestos in your home and its condition.

Asbestos materials become dangerous when:



Broken or in poor condition



Damaged accidentally



Disturbed during renovation or repairs



Loose fill asbestos insulation



Manage asbestos safely

- Monitor the condition of asbestos in your home
- Inform tradespeople of locations of asbestos in your home
- Avoid disturbing or damaging asbestos if working on your home
- Engage a licensed asbestos removalist to remove asbestos

If you suspect your home contains loose fill asbestos insulation, contact Access Canberra

TO WHOM THIS MAY CONCERN

9th March 2026

Certificate of Currency

Dear Sir or Madam,

We, the undersigned Insurance Brokers acting on behalf of the Insured, hereby certify that the following described insurance is in force at this date.

TYPE OF INSURANCE: Professional Indemnity Insurance

INSURED: ACT Property Inspections Pty Ltd.

ADDRESS OF INSURED: Unit 1/33 Atree Court, Phillip ACT 2606, Australia.

POLICY NUMBER: B0507OE2600060

PERIOD: From: 30th March 2026 to: 30th March 2027
At 4pm Local Standard Time at the Principal Address of the Insured.

LIMIT OF LIABILITY: AUD 5,000,000 in the annual aggregate inclusive of costs and expenses plus one reinstatement.

INSURERS: 100% Lloyd's of London

This letter is provided as a matter of information only and confers no rights on the holder. Our duties in relation to this insurance are to our client and we accept no duty of care or responsibility to you or any other third party and any liability to you or a third party is excluded. This letter does not amend, extend, or alter the coverage afforded by the policy, nor does it purport to set out all of the policy terms, conditions and exclusions. The policy terms, conditions, limits, and exclusions may alter after the date of this document or the insurance may terminate or be cancelled, and the limits shown may be reduced to pay claims. We have no obligation to advise you of any changes which may be made to the policy or to advise you of their cancellation or termination.

Issued on behalf of Price Forbes & Partners



Adam Power
Executive Director



**ACT
PROPERTY
INSPECTIONS**

TAX INVOICE

Heidi Hutchison & Michael Hutchison
97 Fitchett St
GARRAN ACT 2605
AUSTRALIA

Invoice Date
6 May 2026

Invoice Number
INV-68121A

ACT Property Inspections
(02) 6232 4540
Unit 1, 33 Altree Ct
PHILLIP ACT 2606
ABN: 33 600 397 466

Description	Quantity	Unit Price	GST	Amount AUD
ACTPLA Fees - No GST	1.00	186.70	GST Free	186.70
Property Report	1.00	1,475.73	10%	1,475.73
Energy Efficiency Report (Complimentary)	1.00	0.00		0.00
Deferred Payment (Complimentary)	1.00	0.00		0.00
			Subtotal	1,662.43
			TOTAL GST 10%	147.57
			TOTAL AUD	1,810.00

Due Date: 2 Nov 2026

Payment terms – Deferred payment account. This account should be paid in full within 14 days on the earlier of:

- (a) Settlement of the property
- (b) If the Property has not been listed for sale within 3 months of the Property Inspection Date
- (c) If the property is no longer listed for sale
- (d) 180 days after the Property Inspection Date

Please pay within the payment terms to avoid the Deferred Payment Fee. Note: all bank/legal fees incurred in obtaining payment will be the customer's responsibility

Payment Options

Pexa : please quote the invoice number as the reference

Direct Deposit : BSB: 012084 Account Number: 194679655

Account Name: ACT Property Inspections Pty Ltd

Please reference your name and invoice number

Cheques : please make payable to ACT Property Inspections Pty Ltd

[View and pay online now](#)

Pool Owner Guidance Material

The ACT Government is committed to avoiding preventable deaths and serious injuries from fatal and non-fatal drownings in home swimming pools and spas in the ACT.

New rules aim to protect the public by making sure that home swimming pools and spas in the ACT have a safety barrier that is compliant with modern safety standards and that they are maintained.

This document outlines the obligations for people who own a property with a *regulated swimming pool* for the period 1 May 2024 to 30 April 2028.

Regulated swimming pools

The new rules apply to regulated swimming pools, which are home swimming pools or spas that are:

- capable of containing water to a depth greater than 30cm; and
- associated with a residential building such as a house, unit, townhouse or block of apartments.

This includes in-ground and above-ground pools, temporary and permanent pools, wading pools, demountable pools, portable pools, kids' pools and spas.

If your inflatable pool can be deflated and inflated and does not have a filtration system you are not covered by the scheme. If any part of the pool requires assembly other than inflation (i.e. has a frame), or if the pool uses or comes with a filtration system, it is a demountable pool and therefore covered by the scheme.

Scheme commencement and transition period

The scheme commences on 1 May 2024, with a four-year transition period for homeowners to have a compliant safety barrier for their regulated swimming pool or obtain an exemption.

Compliant safety barrier

From 1 May 2028, it will be an offence to have a regulated swimming pool that does not have a safety barrier which meets the prescribed safety standards unless an exemption applies.

For pools built, altered or installed before 1 May 2023, the safety standards are:

- the current version of the Building Code of Australia (NCC 2022); and
- two Australian Standards which are Part 1 and Part 2 of Australian Standards for Swimming pool safety.
 - Part 1 (AS 1926.1 – 2012) relates to safety barriers for swimming pools
 - Part 2 (AS 1926.2 – 2007) is about the location of safety barriers

The Building Code and these two Australian Standards are the current safety standards which stop young people accessing pools and lessen the risk of drowning.

The changes that need to be made to swimming pool and spa safety barriers to make them compliant with the prescribed safety standards will depend on the type of safety barrier that is currently in place and the location of the swimming pool or spa in relation to other buildings, structures and boundary fences on the property. Information about what changes you may need to make can be found in the factsheets on the [Home Swimming Pool Safety Reforms](#) webpage on the ACT Government planning website.

Pools built, altered or installed on or after 1 May 2023 must meet:

- the Building Code of Australia as adopted in the ACT at the time the swimming pool or spa is built or altered; and
- the Australian Standards called up by the Building Code at the time the swimming pool or spa is built or altered.

Exemptions

Under the scheme, there are some circumstances where a pool is not required to comply with the prescribed safety standards and the owner of the premises does not need to apply for an exemption.

Date of pool construction	Before 1 May 2023	On or after 1 May 2023
A demountable pool that will not be in place for more than three consecutive days	Yes	Yes
A spa which is covered and secured by a lockable child-resistant structure (such as a door, lid, grille or mesh) that meets the prescribed requirements	Yes	A lockable child-resistant structure will be permitted if it satisfies the prescribed safety standard
A spa that is located on the balcony of an apartment where self-closing and self-latching doors and/or windows restricts access	Yes	A spa located on a balcony must comply with the prescribed safety standard

There are also circumstances where homeowners or owners corporations can apply for an exemption from compliance if the pool is unable to have a safety barrier compliant with the prescribed safety standards.

Date of pool construction	Before 1 May 2013	Between 1 May 2013 and 30 April 2023	On or after 1 May 2023
A swimming pool area is unable to physically accommodate a safety barrier compliant with the prescribed safety standard	Yes	No	No
Compliance with the prescribed safety standard would be reasonably likely to require approval to remove a protected tree	Yes	No	No
Compliance would have a significant adverse effect on the heritage significance of a place or object registered under the <i>Heritage Act 2005</i>	Yes	No	No
Compliance would prevent a person with a disability from accessing the swimming pool	Yes	Yes	No
Documented plans to remove and not replace the swimming pool within 24 months	Yes	Yes	No

Offences and penalties apply for failing to notify of a change of circumstances that affects a ground on which an exemption was granted, and for failing to comply with a condition of an exemption.

Compliance certificates

Pools built, altered or installed before 1 May 2013 will need to obtain a compliance certificate before 1 May 2028 and lodge it with Government within 30 days of issue. Compliance certificates obtained during the transition period will be valid until 1 May 2032.

Pools built, altered or installed on or after 1 May 2013 are not required to obtain a compliance certificate by 1 May 2028 or lodge it with Government. This does not prevent a compliance certificate being obtained before then.

Offences and penalties may apply for failing to meet these obligations.

Maintaining safety around home swimming pools and spas

From 1 May 2024, all owners of a property with a swimming pool or spa are required to maintain their swimming pool or spa safety barriers as an effective and safe child-resistant barrier. All residents of a property with a swimming pool or spa must ensure that all doors, gates and covers providing access to the swimming pool or spa are kept securely closed when not in use. Offences and penalties may apply for failing to meet these obligations.

More information

For more information on the reforms and what they mean for you and your pool, including disclosure obligations on sale or lease of your property, visit the [Home Swimming Pool Safety Reforms](https://www.planning.act.gov.au/projects-priorities/home-swimming-pool-safety-reforms) webpage on the ACT Government planning website: <https://www.planning.act.gov.au/projects-priorities/home-swimming-pool-safety-reforms>



Swimming Pool Disclosure Statement for a Regulated Swimming Pool

Location of regulated swimming pool	Along Rear Fence Line
Date the premises was purchased	September 2021
Date of construction of the premises where the regulated swimming pool is located	21 August 1968
Was the swimming pool built or installed at the same time as the premises?	No
If no, do you know when the swimming pool was built or installed?	25 September 1979
Was building approval issued at any time for the swimming pool or swimming pool area? If yes, please provide details of the building approval	Yes Permit 21779
Are you aware of any alterations to the swimming pool since it was built or installed?	2023
If yes, please provide details of the alterations including dates and type of alteration (where known)	Garden bed, pool fence, sanding of lining
Does a standing exemption apply to the pool? If yes, which one and why (include details of any advice to support this position)	N/A

SHG matter ref 82681