



Residential REPORTS



PRESALE REPORT

9 Stuckey Place

Charnwood

REPORT PREPARED

20 May 2026



35 Poynton Street Hughes



6288 0402



info@residentialreports.com.au

SITE RECORD

ADDRESS	9 Stuckey Place Charnwood	
CLIENT	Jarrod Stirling & Michelle Scott	
OCCUPANCY STATUS	occupied - the dwelling was furnished at the time of inspection	
INSPECTOR - Derek Taylor	INSPECTION DATE - 18 May 2026	WEATHER CONDITIONS - Light rain
JOB REFERENCE - 46947	BLOCK - 5	SECTION - 61

INSPECTION DATA SUMMARY

YEAR OF DEVELOPMENT (APPROX. ISSUE OF FIRST CERTIFICATE OF OCCUPANCY)	<ul style="list-style-type: none"> 1977
AREA DETAILS (APPROX. SQM)	<ul style="list-style-type: none"> Residence - not indicated on plans Garage - not indicated on plans Block size - 799sqm
WALL CONSTRUCTION	<ul style="list-style-type: none"> brick veneer construction. For more information: visit residentialreports.com.au, click on 'resource library' and refer to the publication - Brick Veneer Walls
ROOF CONSTRUCTION	<ul style="list-style-type: none"> timber truss construction concrete tile roof covering
FLOOR CONSTRUCTION	<ul style="list-style-type: none"> timber bearers and joists with tongue and groove flooring
ENERGY RATING	<ul style="list-style-type: none"> 2 stars
CONSTRUCTION	<ul style="list-style-type: none"> the dwelling is of adequate construction and structural workmanship for this type of residential development and its condition is commensurate with the era of construction, design, age and use
MAINTENANCE	<ul style="list-style-type: none"> there are maintenance items detailed in this report, please read the entire report
TIMBER PEST REPORT	<ul style="list-style-type: none"> please review the entire report, including the <i>Timber Pest Overview and Recommendations</i> section, for complete details and context no evidence of active subterranean termites (live species) was found at the time of our inspection evidence of wood decay fungi (wood rot) was found exterior to the building at the time of inspection
COMPLIANCE REPORT	<ul style="list-style-type: none"> For details on structures in this block and section, see the compliance report

IMPORTANT: *This report is intended to be read in its entirety. You must carefully read the full document including Detailed Inspection Information, Warranty & Use and Scope & Limitations prior to making any critical decisions.* The above Data Summary is supplementary to the Report and should not be used as a standalone reference. It is imperative to review the complete Report and in the case of any discrepancies between the Report and the above comments, the information in the detailed Report is the final authority. The reader is requested to immediately contact us if any content is not fully understood and requires clarification or further explanation. We value the opportunity to work on this inspection project and wish you all the best as you evaluate this property.

Signed on behalf of:

Residential Reports Pty Limited ABN 38 609 880 122

Derek Taylor

Derek Taylor

Building & Timber Pest Assessor

INSPECTION SCOPE – INTRODUCTION FOR THE READER

The reader must refer to the comprehensive Warranty & Use and Scope & Limitations at the end of this report. This report is written with reference to the Australian Standards outlined in our Scope & Limitations and is the result of a largely visual inspection only as required by the Standards. The inspection has been conducted to identify notable defects, insofar as an inspector can reasonably identify them and considering the building's age. Comments are provided primarily for items that could impact property value, normal wear and tear for an older building may not be detailed. If there are any discrepancies between the "Summary" and the Detailed Report, the Detailed Report should be relied upon. Where testing is undertaken and there are adverse findings, details will be noted. We do not inspect features such as electrical appliances, utilities, or swimming pool/s and equipment; qualified technicians should be consulted. This report does not quantify ongoing maintenance, upgrades, cosmetic works, or minor defects. If present, significant defects will be noted, and further investigation may be recommended. Where reference has been made to termites (live species, activity or prior activity) and maintenance or defects of significance, we strongly advise that prior to making any critical decisions, that the services of a suitably qualified tradesperson be engaged to quantify remedial action. Report comments may seem repetitive to emphasise that all inspected elements have been reviewed and a summary of inspection items is included at the end of the report for your reference.

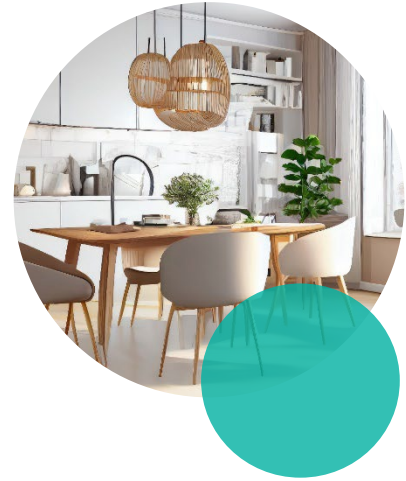

STANDARD INDICATORS EXPLAINED

Our Inspector uses the terms below to describe the condition of building elements. The inspection is visual and conducted under normal lighting. These terms consider factors like the building's age, construction quality and type. Keep in mind that what is considered "good" may vary between an older and a modern building. There are no estimates for repair costs reported, as these depend on your service provider and chosen action:

GOOD	The feature is generally in good condition and does not require major repairs. Minor imperfections in the finish or structure may be present. For elements like windows and doors, the observation refers to a visual inspection only, focusing on substantial defects affecting the property, not operational issues.
FAIR	The feature is functional but has deteriorated and would benefit from cosmetic or remedial repair work.
POOR	The feature in the inspector's opinion, requires remedial action. Repairs or replacement are considered necessary rather than discretionary.
NO SIGNIFICANT DEFECTS	This condition is applied when no significant structural or functional defects are observed. Minor issues may be present, and any remedial action is discretionary.
DEFECTS HAVE BEEN IDENTIFIED	This condition is applied where the inspector has identified defects that require remedial action or investigation considered necessary rather than discretionary.



IMPORTANT NOTE

Your inspector has conducted a comprehensive visual site assessment following Australian Standards for the Building Report and Timber Pest Report. Whilst the reports are considered separate, we've organised all the data for each area into a single table for your convenience. For example, when commenting on fences, you'll find information on both building maintenance and pest considerations in the one table. Where suspected water leakage, termite activity, active or latent, or building defects have been identified in this report, we strongly suggest further investigation. **The reader must refer to the comprehensive Warranty & Use and Scope & Limitations contained in this report as it contains important advice for intending purchasers and for the owner of this building.** A proactive approach to building maintenance and timber pest management is essential to the upkeep of the property.

INTERIOR

Entrance

ceilings and cornices	good
architraves and skirting boards	good
walls	good
doors and windows internal	fair to good <ul style="list-style-type: none"> the entrance door is binding with the timber threshold, adjustment is required

Bedroom One

ceilings and cornices	fair to good <ul style="list-style-type: none"> there are visible repairs to the ceiling lining. This was considered to be of cosmetic significance only. Further repairs are discretionary
architraves and skirting boards	good
walls	fair to good <ul style="list-style-type: none"> there is some minor movement cracking to the wall lining - this is a cosmetic matter and repairs required are minimal
doors and windows internal	fair to good <ul style="list-style-type: none"> the cupboard door is binding with each other, adjustment is required

Bedroom Two

ceilings and cornices	good
architraves and skirting boards	good
walls	fair to good <ul style="list-style-type: none"> there are imperfections to the wall lining from a previous installation
doors and windows internal	good

Bedroom Three

ceilings and cornices	fair to good <ul style="list-style-type: none"> • there are some undulations to the ceiling lining • some of the screws in the plasterboard ceiling are visible
architraves and skirting boards	good
walls	fair to good <ul style="list-style-type: none"> • there is some minor movement cracking to the wall lining - this is a cosmetic matter and repairs required are minimal
doors and windows internal	good

Bathroom

ceilings and cornices	good
architraves and skirting boards	fair to good <ul style="list-style-type: none"> • the architrave has been affected by water penetration in some areas, moisture meter readings were normal at the time of inspection
walls	good
doors and windows internal	fair to good <ul style="list-style-type: none"> • the window frames are showing signs of deterioration
vanity/hand basin	fair to good <ul style="list-style-type: none"> • the vanity has been mildly affected by water penetration
shower screen	good
bath	fair to good <ul style="list-style-type: none"> • the bath has some marks and signs of wear
ventilation	<ul style="list-style-type: none"> • ceiling fan unit (with heat lamps) • several of the heat lamps are not working
water leakage	<ul style="list-style-type: none"> • no water leakage detected in accessible areas
wall tiles	good
floor tiles	good
fit-out	fair to good <ul style="list-style-type: none"> • the mirror is showing signs of deterioration
hardware, fixtures and fittings	good

Toilet

ceilings and cornices	good
architraves and skirting boards	good
walls	fair to good <ul style="list-style-type: none"> • there are visible repairs to the wall lining. This was considered to be of cosmetic significance only. Further repairs are discretionary
doors and windows internal	good
toilet suite	good
water leakage	<ul style="list-style-type: none"> • no water leakage detected in accessible areas
ventilation	<ul style="list-style-type: none"> • there is no mechanical ventilation
floor tiles	good
hardware, fixtures and fittings	good

Laundry	
ceilings and cornices	fair to good <ul style="list-style-type: none"> • there are paint defects to the ceiling lining
architraves and skirting boards	good
walls	good
doors and windows internal	fair to good <ul style="list-style-type: none"> • the windows require adjustment or new rollers to ensure smooth operation
laundry tub	good
water leakage	<ul style="list-style-type: none"> • no water leakage detected in accessible areas
ventilation	<ul style="list-style-type: none"> • there is no mechanical ventilation
wall tiles	good
floor tiles	fair to good <ul style="list-style-type: none"> • there is a cracked tile • some areas of the floor tiling are drummy, this condition is indicative of adhesion problems - tile repairs or retiling will eventually be required
hardware, fixtures and fittings	good

Kitchen, Meals and Family Area	
ceilings and cornices	fair to good <ul style="list-style-type: none"> • there are some undulations to the ceiling lining • some of the screws in the plasterboard ceiling are visible • there are paint defects to the ceiling lining • there are visible repairs to the ceiling lining. This was considered to be of cosmetic significance only. Further repairs are discretionary
architraves and skirting boards	good
walls	good
doors and windows internal	fair to good <ul style="list-style-type: none"> • the entrance door is binding with the frame, adjustment is required
sink	good
splashback	good
ventilation	<ul style="list-style-type: none"> • ventilation is provided by an externally ducted range hood
hardware, fixtures and fittings	good
kitchen fit-out	fair to good <ul style="list-style-type: none"> • the kitchen fit-out is in functional condition with normal wear and tear evident • the kitchen fitout has been affected by moisture penetration in some areas

Lounge and Dining Room Area

ceilings and cornices	fair to good <ul style="list-style-type: none">• there is some minor movement cracking to the ceiling lining - this is a cosmetic matter and repairs required are minimal• there are visible repairs to the ceiling lining. This was considered to be of cosmetic significance only. Further repairs are discretionary• there are paint defects to the ceiling lining• there are some undulations to the ceiling lining
architraves and skirting boards	good
walls	good
doors and windows internal	good

Hallway

ceilings and cornices	fair to good <ul style="list-style-type: none">• there are paint defects to the ceiling lining
architraves and skirting boards	good
walls	good
doors and windows internal	fair to good <ul style="list-style-type: none">• the cupboard door is binding with each other, adjustment is required

Roof Cavity

insulation	<ul style="list-style-type: none">• the roof cavity has been insulated with fibreglass batts and loose-fill insulation. PLEASE NOTE: We are not licensed to inspect for asbestos and the loose-fill insulation has not been tested. However, we are of the opinion that the loose-fill insulation is not friable asbestos• For more information: visit residentialreports.com.au and click on 'resource library'.
sarking	<ul style="list-style-type: none">• no sarking has been installed in the roof cavity• For more information: visit residentialreports.com.au, click on 'resource library' and refer to the publication - Sarking
roof construction	<ul style="list-style-type: none">• timber truss construction
termites - roof void	<ul style="list-style-type: none">• no active termites and/or termite damage or workings were observed in the areas accessible at the time of inspection
wood decay - roof void	<ul style="list-style-type: none">• no evidence of wood decay (rot) fungi damage was sighted in areas accessible at the time of inspection
borers - roof void	<ul style="list-style-type: none">• no evidence of borer damage was sighted in areas accessible at the time of the inspection

Interior/Main Dwelling

termites - interior	<ul style="list-style-type: none">• no active termites and/or termite damage or workings were observed in the areas accessible at the time of inspection
wood decay - interior	<ul style="list-style-type: none">• no evidence of wood decay (rot) fungi damage was sighted in areas accessible at the time of inspection
borers - interior	<ul style="list-style-type: none">• no evidence of borer damage was sighted in areas accessible at the time of the inspection

Inspection Items	
roof exterior	<p>defects have been identified</p> <ul style="list-style-type: none"> • concrete tile roof covering • bedding and pointing repairs are required to the hip capping adjacent to the main pergola • some roof tiles have broken corners, this is a common problem with concrete and terracotta tiles. Leakage rarely occurs and generally repairs are not required
gutters and downpipes	<p>defects have been identified</p> <ul style="list-style-type: none"> • there is leakage occurring at some gutter and or downpipe section joins. Remedial action may include sealing of the leak with an appropriate sealant. Monitoring and maintenance of guttering is recommended to ensure optimum performance • gutters need to be cleared of leaf litter, silt and debris to ensure that maximum roof drainage occurs in all weather conditions. Additionally, the leaf litter may be concealing rust or defects • gutters are retaining water in some areas. Realignment to ensure that they drain correctly may be a consideration. Gutters that retain water tend to rust through prematurely • some areas of the guttering are rusted and will need to be repaired or replaced. In older properties where the guttering has deteriorated, it may be prudent to monitor and review the roof drainage system • one of the downpipes is not connected to the stormwater. Where stormwater is not directed into the drainage system, care should be taken to ensure that stormwater is directed away from the building
eaves, fascia and barge ends	<p>defects have been identified</p> <ul style="list-style-type: none"> • some sections of the eave lining have disengaged, refixing to the eave battens and repair or replacement of the cover strips is recommended • the eave linings are water stained in some areas. This generally indicates that roof drainage at some time has been ineffective. This can be a result of storm activity which creates an environment where the roof drainage system cannot cope. The drainage system, including underground stormwater pipes should be monitored to ensure that it is operating effectively. Care should be taken to ensure that gutters are kept clear of leaf litter, debris and silt deposits • there is timber decay in the fascia boards • damage in the area/s noted appears to be moderate
wall construction exterior	<p>defects have been identified</p> <ul style="list-style-type: none"> • brick veneer construction • there is movement cracking in the exterior masonry, while the cracks were not considered to be structurally significant at the time of our inspection, they should be monitored over time to ensure that there is no ongoing movement • overgrowth in some areas has limited our inspection - we are unable to determine the condition of the wall structure in concealed areas

doors and windows external	<p>defects have been identified</p> <ul style="list-style-type: none"> • window frames are deteriorating due to exposure to the elements, to prolong the serviceable lifespan maintenance and painting may be a consideration • some aluminium windows require maintenance to ensure smooth operation
floor construction	<p>no significant defects</p> <ul style="list-style-type: none"> • timber bearers and joists with tongue and groove flooring • there is no evidence that the floor has any significant defects, floor coverings prohibit a visual inspection so it is possible that some minor defects may be concealed • there are some squeaky floor boards. Squeaky floor boards are not generally structurally significant and in this instance we have no concerns regarding structural integrity
driveway	<p>no significant defects</p> <ul style="list-style-type: none"> • the condition of the driveway paving is commensurate with the age of the development, typically over time the paving will develop cracks and undulations often as a result of tree root intrusion or the subsidence of the sub soil. This deterioration is primarily cosmetic in nature, and vehicle access remains generally acceptable
paths and paving	<p>no significant defects</p> <ul style="list-style-type: none"> • the condition of the paving is commensurate with the age of the development, typically over time the paving will develop cracks and undulations often as a result of tree root intrusion or the subsidence of the sub soil
steps and stairs external	no significant defects
retaining walls	no significant defects
grounds	<p>defects have been identified</p> <ul style="list-style-type: none"> • evidence of timber decay (wood rot) was noted in some garden borders • damage in the area/s noted appears to be moderate
swimming pool or spa	<ul style="list-style-type: none"> • the spa, filtration equipment and safety fencing, gates and other aspects of swimming pool safety are not included in this report. A self closing, self latching gate is not present. To obtain specific information relative to these items and advice regarding optimum pool safety barrier systems it will be necessary to commission an inspection by a suitably qualified technician. Safety requirements are not related to the specifications contained in the current Building Code of Australia • For more information: visit residentialreports.com.au, click on 'resource library' and refer to the publication - Swimming Pool and Spa Regulations & Swimming Pool and Spa Safety
solar unit	<ul style="list-style-type: none"> • solar panels have been installed; the solar installation is not included in this inspection therefore, we do not comment on any aspect of its operation. Where solar panels have been installed, we are unable to apply a condition to the area of roof covering beneath due to restricted access
fences and gates	<p>defects have been identified</p> <ul style="list-style-type: none"> • timber decay is evident in cross-timber and timbers in contact with the ground in some areas • damage in the area/s noted appears to be moderate • vegetation and screening in some areas of the fence line limited our inspection. We were unable to determine the condition of the fencing in those areas

Subfloor	
subfloor access and general	<ul style="list-style-type: none"> our inspection was restricted by stored goods, low clearances and ductwork
subfloor drainage & ventilation	<ul style="list-style-type: none"> whilst we are not plumbers, our inspection indicates that the subfloor drainage and ventilation is generally fair, inadequate drainage can lead to an environment conducive to timber pests, and improvement options such as vent airflow should be considered
termites - subfloor	<ul style="list-style-type: none"> no active termites and/or termite damage or workings were observed in the areas accessible at the time of inspection
wood decay - subfloor	<ul style="list-style-type: none"> no evidence of wood decay (rot) fungi damage was sighted in areas accessible at the time of inspection
borers - subfloor	<ul style="list-style-type: none"> no evidence of borer damage was sighted in areas accessible at the time of the inspection

Carport	
carport type	<ul style="list-style-type: none"> double carport
roof exterior	<p>good</p> <ul style="list-style-type: none"> metal deck roof covering
gutters and downpipes	<p>fair to good</p> <ul style="list-style-type: none"> there is leakage occurring at some gutter and or downpipe section joins. Remedial action may include sealing of the leak with an appropriate sealant. Monitoring and maintenance of guttering is recommended to ensure optimum performance gutters need to be cleared of leaf litter, silt and debris to ensure that maximum roof drainage occurs in all weather conditions. Additionally, the leaf litter may be concealing rust or defects some of the downpipe clips have disengaged, repair is recommended there is impact damage to the gutters or downpipes in some areas, the area remains in a functional condition
floor construction	<p>fair to good</p> <ul style="list-style-type: none"> concrete slab construction there are cracks in the concrete slab, however, we are of the opinion they are not structurally significant. Cracks need to be monitored over time to determine if any remedial action is required
structural integrity	<p>good</p>
termites - carport	<ul style="list-style-type: none"> no active termites and/or termite damage or workings were observed in the areas accessible at the time of inspection
wood decay - carport	<ul style="list-style-type: none"> evidence of wood decay fungi (wood rot) was found in, but not necessarily limited to, the areas noted below; some exposed roofing timbers damage in the area/s noted appears to be moderate
borers - carport	<ul style="list-style-type: none"> no evidence of borer damage was sighted in areas accessible at the time of the inspection

Front Deck	
decking timbers	good
deck support posts	good <ul style="list-style-type: none"> • deck support posts are supported by metal stirrups
hand railing/balustrade	fair to good <ul style="list-style-type: none"> • re-tensioning of the stainless steel wire balustrade is recommended
structural integrity	<ul style="list-style-type: none"> • where reference has been made in this report to an elevated structure such as a deck balcony or verandah, it is important to note that we are not Structural Engineers and accordingly our advice is limited. Any opinion relating to structural integrity is relative to weight loadings typical of a normal household event. Prior to loading the structure beyond normal which may occur at a larger gathering, we recommend that professional advice be obtained to determine that the structure will safely cope with the weight loading. Additionally, the structure should be regularly inspected to ensure that structural integrity is maintained
termites - deck	<ul style="list-style-type: none"> • no active termites and/or termite damage or workings were observed in the areas accessible at the time of inspection
wood decay - deck	<ul style="list-style-type: none"> • no evidence of wood decay (rot) fungi damage was sighted in areas accessible at the time of inspection
borers - deck	<ul style="list-style-type: none"> • no evidence of borer damage was sighted in areas accessible at the time of the inspection

Front Low Level Deck	
decking timbers	good <ul style="list-style-type: none"> • the deck substrate timbers could not be inspected because of the low clearance to the ground. However, our inspection indicated that there are no significant structural problems
deck support posts	no condition has been applied <ul style="list-style-type: none"> • we were unable to inspect all areas of the deck substrate, therefore we cannot comment on the overall condition of posts that are not visible
structural integrity	good
termites - deck	<ul style="list-style-type: none"> • no active termites and/or termite damage or workings were observed in the areas accessible at the time of inspection
wood decay - deck	<ul style="list-style-type: none"> • evidence of wood decay fungi (wood rot) was found was found in, but not necessarily limited to, the areas noted below; • floor framing
borers - deck	<ul style="list-style-type: none"> • no evidence of borer damage was sighted in areas accessible at the time of the inspection

Deck and Pergola	
decking timbers	good <ul style="list-style-type: none"> the deck substrate timbers appear to be in good condition
deck support posts	good <ul style="list-style-type: none"> deck support posts are supported by metal stirrups
pergola roof	good <ul style="list-style-type: none"> polycarbonate roof
hand railing/balustrade	good
structural integrity	<ul style="list-style-type: none"> where reference has been made in this report to an elevated structure such as a deck balcony or verandah, it is important to note that we are not Structural Engineers and accordingly our advice is limited. Any opinion relating to structural integrity is relative to weight loadings typical of a normal household event. Prior to loading the structure beyond normal which may occur at a larger gathering, we recommend that professional advice be obtained to determine that the structure will safely cope with the weight loading. Additionally, the structure should be regularly inspected to ensure that structural integrity is maintained
termites - deck pergola	<ul style="list-style-type: none"> no active termites and/or termite damage or workings were observed in the areas accessible at the time of inspection
wood decay - deck pergola	<ul style="list-style-type: none"> no evidence of wood decay (rot) fungi damage was sighted in areas accessible at the time of inspection
borers - deck pergola	<ul style="list-style-type: none"> no evidence of borer damage was sighted in areas accessible at the time of the inspection

Deck (Around Spa)	
decking timbers	good <ul style="list-style-type: none"> the deck substrate timbers could not be inspected because of the low clearance to the ground. However, our inspection indicated that there are no significant structural problems
deck support posts	no condition has been applied <ul style="list-style-type: none"> we were unable to inspect all areas of the deck substrate, therefore we cannot comment on the overall condition of posts that are not visible
pergola roof	good <ul style="list-style-type: none"> polycarbonate roof
structural integrity	<ul style="list-style-type: none"> where reference has been made in this report to an elevated structure such as a deck balcony or verandah, it is important to note that we are not Structural Engineers and accordingly our advice is limited. Any opinion relating to structural integrity is relative to weight loadings typical of a normal household event. Prior to loading the structure beyond normal which may occur at a larger gathering, we recommend that professional advice be obtained to determine that the structure will safely cope with the weight loading. Additionally, the structure should be regularly inspected to ensure that structural integrity is maintained
termites - deck	<ul style="list-style-type: none"> no active termites and/or termite damage or workings were observed in the areas accessible at the time of inspection
wood decay - deck	<ul style="list-style-type: none"> no evidence of wood decay (rot) fungi damage was sighted in areas accessible at the time of inspection
borers - deck	<ul style="list-style-type: none"> no evidence of borer damage was sighted in areas accessible at the time of the inspection

TIMBER PEST - OVERVIEW & RECOMMENDATIONS

Overall risk - pest	<ul style="list-style-type: none"> considering all of the relevant factors, it is our opinion that the overall degree of risk of timber pest infestation to the property is MODERATE to HIGH - we strongly recommend that regular inspections are undertaken
Evidence of timber pests	<ul style="list-style-type: none"> no evidence of active subterranean termites (live species) was found at the time of our inspection evidence of wood decay fungi (wood rot) was found exterior to the building at the time of inspection
Evidence of a termite nest	<ul style="list-style-type: none"> no, please read the report in full
Evidence of a pest treatment	<ul style="list-style-type: none"> we found no evidence of any recent termite treatment or durable notice at the time of inspection
Pest treatment required?	<ul style="list-style-type: none"> considering there is no evidence of a pest treatment, we recommend that a regular pest management program in accordance with Australian Standard 3660.1 to prevent subterranean termites from infesting the property be implemented. A proactive approach to Timber Pest Management will offer the highest protection for the building. A management proposal can be obtained by contacting our office on 6288 0402, or please contact your regular inspector.
We recommend pest inspections are conducted every:	<ul style="list-style-type: none"> 6 to 12 months
Drainage and ventilation	<ul style="list-style-type: none"> whilst we are not plumbers, it is considered that the drainage is generally acceptable
Mould	<ul style="list-style-type: none"> mould was not observed at time of inspection <p>Mould on walls and ceilings etc; is an indicator of high moisture or very poor ventilation. If reported you should commission further investigation by a builder or an Industry Hygienist as its presence may indicate a water leak, wood decay or termites behind the wall or ceiling sheeting.</p>
Weep holes	<p>Were the weep holes clear allowing the free flow of air?</p> <ul style="list-style-type: none"> not applicable, suspended timber floor construction <p>Weep holes are small openings that allow water to drain from within an assembly. Weeps are located at the bottom of the building to allow for drainage. It is important that soil, lawn, concrete paths or pavers do not cover the weep holes. Sometimes they have been covered during the rendering of the brick work. They should be clean and free flowing. Covering the weep holes in part or in whole may allow undetected termite entry.</p>
Slab edge exposure	<p>Is the slab edge exposed?</p> <ul style="list-style-type: none"> not applicable, suspended timber floor construction <p>Where external concrete slab edges are not exposed there is a high risk of concealed termite entry. In some buildings built since July 1995 the edge of the slab forms part of the termite shield system. In these buildings an inspection zone of at least 75mm should be maintained to permit detection of termite entry. The concrete edge should not be concealed by render, tiles, cladding, flashings, adjoining structures, paving, soil, turf or landscaping etc. Where this is the case, you should arrange to have the slab edge exposed for inspection. Concealed termite entry may already be taking place but could not be detected at the time of the inspection. This may result in concealed timber damage.</p>

Termite shields (ant caps) cont.	<p>In our opinion the termite shields appear to be:</p> <ul style="list-style-type: none"> adequate <p>Termite Shields should be in good order so termite workings are exposed and visible. This helps stop termites gaining undetected entry. Joints in the shielding should have been soldered or sealed with an approved sealant as per AS 3660 during the installation. Whenever it is observed that the joints in the shielding have not been soldered then the shielding must be reported as inadequate. It may be possible for a builder to repair the shielding. If not, a chemical treated zone may need to be installed to deter termites from gaining concealed access to the building. Missing, damaged or poor shields increase the risk of termite infestation. Other physical shield systems are not visible to inspection and no comment is made on such systems.</p>
Hot water, air conditioning and water tanks	<p>Units that release water alongside or near to building walls need to be connected to a drain. If this is not possible then their water outlet needs to be piped several meters away from the building, as the resulting wet area is highly conducive to termites.</p> <p>Is there a need for work to be carried out?</p> <ul style="list-style-type: none"> no - all units appear to be connected to a drain or piped away on the day of inspection
General recommendations	<ul style="list-style-type: none"> As this property is located in an area where subterranean timber pests are commonly found we strongly recommend that you have regular inspections carried out no later than every 6 - 12 months (or as specifically recommended above) to ensure that there is no termite activity present in your buildings and structures. Any untreated timbers in direct contact with the soil are very conducive to attack from subterranean termites. These should be removed and replaced with a material not conducive to attack such as brick, stone, concrete or treated timber. Large trees (particularly eucalypt variety) are regular nesting sites for the most common termite species found in our region. Trees on the property have been visually inspected up to a height of 2 metres, where possible and practicable for signs of termite activity. It is however, very difficult and generally impossible to locate a termite nest visually as they are underground and evidence in trees is usually well concealed. Drilling and testing of large trees is recommended to determine if they are harbouring a termite nest. Garden beds, mulch and foliage against the structure can create conditions that are highly conducive to timber pest attack. Clearing is recommended.

It should be noted that if the risk factor specified in this report is considered to be high it is encouraging awareness that increased vigilance is warranted. Any recommendations regarding reducing conditions that are conducive to timber pests or frequency of inspections must be observed. If termite activity, active or latent, has been identified in this report, we strongly suggest an invasive inspection is carried out. To safeguard against potential timber pest attack, we recommend that a full inspection be undertaken every 6-12 months at a minimum or as specifically recommended above. We strongly encourage the property owner to consider implementing a Timber Pest Preventative Management Plan, which includes periodic Termite Inspections. A proactive approach will help ensure the ongoing protection of the property. Please call our office on 6288 0402 for advice and information or to arrange a customised schedule for this building or contact your regular inspector.

Plan No. (if applicable)	Description	Date of COU Approvals (Certificate of Occupancy)	Comments
43945	superseded		<ul style="list-style-type: none"> this plan has been superseded
43945/A	residence	22/02/1977	
43945/B+/C	brick carport	29/09/1977	
43945/D	pergola	14/11/1983	<ul style="list-style-type: none"> the structure has been removed
	retaining walls, children's playhouse, raised garden bed, water tank, low level deck		<ul style="list-style-type: none"> approval is not required
	shipping container		<ul style="list-style-type: none"> approval is not required
	kitchen and bathroom renovations		<ul style="list-style-type: none"> building or development approval is not required
	rear bench seating		<ul style="list-style-type: none"> approval is required within 1.5m of boundary over 0.4m in height from ground
	front deck and stairs		<ul style="list-style-type: none"> approval is required deck is over 1m from ground level
	rear deck and pergola		<ul style="list-style-type: none"> approval is required deck is over 1m from ground level pergola is over 3m from ground level
	deck and pergola over spa		<ul style="list-style-type: none"> approval is required the structure exceeds 0.4m in height and is located between the secondary building line and a boundary line facing crown land
	spa		<ul style="list-style-type: none"> approval is required for any water vessel in excess of 300mm in depth

For any incomplete approvals please email acbuildingconveynce@act.gov.au for further information on how to complete.

COMPLIANCE REPORT NOTATION

IMPORTANT NOTE - We obtained a Building File from Access Canberra to complete this Compliance Report. This report relates to Building and Development approvals only. The building file may contain floor plans, elevations, Certificates of Occupancy & Use, index, survey reports, and drainage plans. Our report is based on examining these documents and conducting a visual inspection, focusing on compliance matters from the provided file. Please be aware that if plan details are unclear or compromised, we are not liable for any omissions or errors. Refer to more details about Compliance in our Scope & Limitations. For information regarding current dimensions and approvals you can visit: planning.act.gov.au/topics/design_build/da_assessment/exempt_work

EASEMENTS - An easement is a section of land registered on your property which gives another party the right to access it for a specific purpose. An example is a section of the property that contains municipal services such as electricity, or drainage infrastructure. If a structure requires approval and is located on an easement the appropriate utility provider is consulted during the certification process and it is they who determine if an application for approval will be supported.

TCCS, PLUMBING & ELECTRICAL APPROVAL - If this report notes structures or alterations that require Transport Canberra & City Services (TCCS), Plumbing or Electrical Approval or cites plumbing and electrical additions and or alterations, please note that approval may have been granted, however, documentation is not provided in the building file. The Environment & Planning Directorate or the owner may have further information.

DEVELOPMENT APPROVAL - If this report identifies structures that require Development Approval, information relating to the status of Development Approvals will be shown on the Lease Conveyancing Enquiry provided by the solicitor. This will be included in the Conveyancing Contract for Sale. The status of a pending Development Approval is not contained within the building file we receive.

SWIMMING POOLS & SPAS - The ACT Government has introduced reforms to home swimming pool safety, with a focus on swimming pool safety barriers. The reforms commence on 1 May 2024, with a four-year transition period. The scheme imposes requirements for information about the safety standard of a regulated swimming pool to be disclosed on the sale of a property. Owners must provide prescribed information including: exemption certificate, compliance certificate, swimming pool disclosure statement, certificate of occupancy for the pool and safety barriers that is not older than 5 years and 'Pool Owners Guidance Material' which outlines the obligations on owners of premises on which a regulated swimming pool is located. If this information is not provided in this report, you must request a copy. For more information on the reforms visit the ACT Government's Planning website.

EXTENSIONS - Where an extension or addition has been made to a property, it can create a potential gap or discontinuity in the termite barrier system. This gap occurs between the original structure and the new addition. Termite barriers are critical in aiding the prevention of undetected subterranean termites from entering the dwelling, and any interruption in the barrier can compromise its effectiveness. We are unable to report on the existence, condition or continuity of the termite barrier system between the existing dwelling and additions or alterations.

Restricted access caused by stored goods, furnishings, window treatments, floor coverings, security devices, vegetation, duct work, confined spaces, insulation and other impediments will limit the scope of this inspection. Whilst every effort has been made to conduct a comprehensive roof cavity and subfloor inspection there are limitations relative to safe access requirements which include low clearances, the availability of safe walk-ways and work-safe temperatures, which when applicable, will limit the inspection. The roof exterior is inspected when accessible from a 3.6 metre ladder, or from ground level where there are height restrictions. Only structures, fences and/or trees within 30m of the building but within the property boundaries were inspected. No inspection was made, and no report is submitted with respect to inaccessible areas. These include, but may not be limited to, cavity walls, concealed frame timbers, eaves, flat roofs, fully enclosed patios, subfloors, soil concealed by concrete floors, wall linings etc. Where a property is furnished at the time of the inspection the furnishings and stored goods may be concealing evidence of Timber Pest Activity. This evidence may only be revealed when the property is vacated. A further inspection of the vacant property is strongly recommended in this case. Please note where a complete inspection of any area was not possible, timber pest activity and/or damage may exist in these areas. Prior to making any critical decisions, further inspections are strongly recommended to areas where reasonable access is unavailable, obstructed or restricted or a high risk of possible timber pests and /or damage exists.

9 Stuckey Place Charnwood	
Area	Restrictions
INTERIOR	access during inspection of the interior of the property was restricted by: <ul style="list-style-type: none"> - furniture and stored goods including in cupboards and under sink units - window treatments and floor coverings - stored goods within the dwelling
SUBFLOOR	subfloor access was significantly restricted by: <ul style="list-style-type: none"> - low clearances - duct work - stored goods - there is insufficient crawl space in part of the sub-floor and therefore some areas were viewed from a distance due to restricted access. Please refer to our Scope and Limitations section at the end of this report under the heading "Safe and Reasonable Access"
ROOF CAVITY	our inspection of the roof cavity was restricted by: <ul style="list-style-type: none"> - low clearances - insulation covering the ceiling framing - inspection around the eaves was restricted due to low pitch and clearances
ROOF EXTERIOR	roof exterior: <ul style="list-style-type: none"> - safety harness anchors and edge restraints were not available. Work Health and Safety regulations required a top of ladder inspection
GROUND & EXTERNAL STRUCTURES	access to the inspection of grounds/external structures was restricted by: <ul style="list-style-type: none"> - vegetation restricted visual inspection to some areas - under the deck was restricted due to low construction - stored goods restricted access to some areas

WARRANTY & USE OF OUR REPORTS

This report is **intended to be read in its entirety**. The report is written solely for the use and benefit of:

The Client named in this report

The Purchaser of the property

No liability or responsibility in contract or tort or statute is accepted to any Other Party who may rely on the report wholly or in part. Any Other Party acting or relying on this report, wholly or in part, does so at their own risk. Additionally, no liability or responsibility will be accepted if the invoice for this report is not paid on or before settlement of the sale contract or within one hundred and eighty (180) days from the date of inspection.

No liability shall be accepted on account of failure of the report to notify any termite activity and/ or damage present at or prior to the date of the report in any areas of the subject property physically inaccessible, or to which access for inspection is denied by or to the Inspector including but not limited to any areas so specified by the Report. Furthermore, we do not assume liability for any omissions, errors, or inaccuracies in documents provided by external agencies, the client, or their representative. The report is only an opinion of Residential Reports and is valid for one hundred and eighty (180) days from the date of inspection as per the Civil Law (Sale of Residential Property) Act. No liability will be accepted or claims considered after the expiration of this period of liability.



Before the property exchange, you will have the opportunity to attend a pre-settlement inspection to conduct your due diligence. Carefully consider the building's age and its impact on elements like windows, doors, and cupboards. Our inspectors do not assess ongoing maintenance, and as such you or your representative should personally appraise relevant building elements. If it is claimed that there is an omission relating to this report, Residential Reports must be notified in writing before any action is taken. No liability shall be accepted where any costs (including for remedial action or professional advice) are incurred by the claimant prior to Residential Reports receiving written notification along with evidence of the defect or omission, being given a reasonable opportunity to re-inspect the property, obtain professional advice and propose a resolution or arrange for rectification work to be undertaken. Unless costs are specified and agreed to in writing, no liability will be accepted. No liability shall be accepted for any costs incurred in excess of the reasonable costs required to rectify the defect or omission claimed. ***This report supersedes any other report, verbal or written, given to you by this company in respect of this property. If you have questions or do not understand any part of this document and require clarification, please contact us prior to acting on this report. Copyright remains with Residential Reports, the report content, style and presentation is not to be copied or reproduced without written authority of the Company.***

SCOPE & LIMITATIONS OF OUR INSPECTION

This report has been prepared as a result of a largely **VISUAL INSPECTION ONLY** with limited operational testing conducted as required by Australian Standard AS 4349.0-2007 Inspection of Buildings (General requirements), AS 4349.1-2007 Inspection of Buildings (Pre-purchase inspections - Residential Buildings) and AS 4349.3 - 2010 Inspection of Buildings Part 3: Timber Pest Inspections. It is limited to the condition of those areas of the property that were fully accessible (see Safety and Reasonable Access) and visible to the inspector at the time of inspection. In the case of a Strata type property, our inspector only undertakes an examination of the interior of the unit. You must read the entire report and Scope & Limitations sections before reaching any conclusions regarding our opinion of the property's condition. Any person relying on this report acknowledges the following clauses, which define the Scope and Limitations of the inspection and form an integral part of the report.

LIMITATION OF LIABILITY

This report is valid on the date of inspection. Responsibility is not accepted for any matter that is not evident, or, for any deterioration of the property that occurs after the date of the inspection. The inspection is a visual assessment only.

The operation/working condition of limited features may have been commented on during the course of our inspection. Operational testing is limited, where testing occurs and a defect is identified, this defect may be noted in the Report if it is a major defect and may be investigated further to provide more detail. However, this does not impose on the inspector any further obligation to test each same item, nor does it impose an obligation to make note if in the inspector's reasonable view, the defect is not a major defect. There is no guarantee

that items referenced will operate as intended at a later date. Prior to purchase, the purchaser must conduct their own due diligence most particularly where defects have been documented in this report so that they are able to quantify the extent and cost of required remedial action. The Purchaser acknowledges that they should not solely rely on this Report as to the exact condition of the property and that they should obtain independent advice from a qualified technician relative to required remedial actions.

Concealed areas are not reported on. Concealed defects may include, but are not limited to:

- Breakage, blockage or interference with concealed pipes, concealed window and door mechanisms
- Defective service installations
- Any part of the structure which is underground or concealed e.g. footings, wall and ceiling framing, concealed floor structures
- Areas concealed by furnishings, fixtures and fittings or stored goods, low clearances or where safe access is not possible.

Responsibility is not accepted for defects which are latent or otherwise not reasonably detected in a visual inspection without interference with, removal or breaking apart of any of the structure including fixtures, fittings, furniture, insulation or stored items within and around the building. The inspector notes that some defects may be concealed, obstructed and/or inaccessible at the time of the inspection. The reader should be aware that various features of the property such as large and heavy furniture, as well as electrical goods including washing machines and fridges may obstruct the view of the inspector and/or make possible defects inaccessible such that their visibility to the inspector is limited and they may not be identified. The Purchaser acknowledges that Residential Reports will not accept any liability for concealed, obstructed and/or inaccessible defects that the inspector does not identify.



EXCLUSION OF ITEMS FROM INSPECTION

AS 4349.1 – 2007 excludes reporting of the following items: Footings below ground, concealed damp-proof course, electrical installations, operation of smoke detectors, light switches and fittings, TV, sound and communications and security systems, concealed plumbing, adequacy of roof drainage as installed, gas fittings and fixtures, air-conditioning, automatic garage door mechanisms, swimming pools and associated filtration and similar equipment, the operation of fireplaces and solid fuel heaters, including chimneys and flues, alarm systems, intercom systems, soft floor coverings, electrical appliances including dishwashers, incinerators, ovens, ducted vacuum systems, paint coatings, except external protective coatings, health hazards (e.g., allergies, soil toxicity, lead content, radon, presence of asbestos or urea formaldehyde), timber and metal framing sizes and adequacy, concealed tie-downs and bracing, timber pest activity, other mechanical or electrical equipment (such as gates, inclinators, soil conditions, control joints, sustainable development provisions, concealed framing-timbers or any areas concealed by wall linings/sidings, landscaping, rubbish, floor covers, furniture and accessories, stored items, insulation, environmental matters (e.g., BASIX, water tanks, BCA Environmental Provisions), energy efficiency, lighting efficiency.

WHAT THE INSPECTOR EXAMINES TO PREPARE A PROPERTY REPORT...

...AND IMPORTANT NOTES ABOUT THESE AREAS

The following outlines aspects of the property that can be examined through visual inspection, derived from the Australian Standard AS4349.1–2007. Comments are generally provided only if significant issues are found. The inspector didn't move or remove any coverings or furnishings, which could hide defects. Damage to concealed structures or pest activity may not be visible due to foliage or other obstructions. This report is a guide for potential buyers and should complement your own inspection and due diligence. Some aspects are subjective, so consider factors like presentation, past maintenance, and construction age when forming opinions.

DOORS & DOOR FRAMES - Defective hardware – significant, rotting/corroded frames, loose/badly fitting doors, damage.

EXTERNAL ROOF COVERING, FASCIAS, GUTTERS & DOWNPIPES - Tiles/slates, sheet roofing, flashing, skylights, vents, downpipes, valleys, guttering, eaves, fascia boards, barge ends. Roof waterproof integrity and roof drainage is not tested during our inspection therefore it is not possible to determine the effectiveness of the roof cover and drainage system under all conditions. It is important to note that a visual inspection of the roof covering may not identify roof leakages. Roof design can have a significant impact on roof drainage. Low pitched construction can, in adverse weather conditions lead to flooding of the roof cover. Effective roof drainage is absolutely critical for a flat framed or low pitch roof. Flooding of the roof cover can result in water ingress within the building envelope. Roof drainage and the stormwater systems are not tested at the inspection. Inadequate, blocked or non-existent stormwater drains are often accountable for problems relating to roof drainage. Repainting of timber can mask the existence of timber rot. We cannot guarantee that all timbers are sound. A visual inspection may not, in some circumstances, detect roofing timbers affected by rot.

EXTERNAL WALLS & NON-STRUCTURAL RETAINING WALLS - Bricks, mortar, render, cracking/movement, dampness, visible flashing, weep holes, joint sealants, perpend, decay. Settlement cracks, if present, need to be monitored over a period of time to determine if an ongoing structural problem exists. If any reference has been made in this report to cracking, settlement and or movement, it should be noted that we are not experts in this area and further advice, if considered necessary, should be obtained from a Structural Engineer.

FENCES & GATES - Palings/panels, rails, posts, sagging, timber decay (rot).

FLOORS - TIMBER: Springy or squeaky boards/sheeting, timber decay (rot), out of level – significant, undulations - significant, dampness/water damage; **CONCRETE**: cracking, out of level – significant; **HARD FLOORING**: cracking, loose or drummy units, dampness/water damage

INTERNAL ROOF SPACE - Framing, insulation, sarking, party walls (if applicable). Sarking is a foil insulation/vapour barrier. Used in conjunction with bulk insulation, sarking provides an ideal insulation system for the control of heat and condensation. Sarking can only be installed during construction.

KITCHEN - Fit out, sealants, ventilation, taps, leakage, sink, drummy/cracked/missing tiles, grout defects. This report does not cover any matters relating to the operation of electrical or gas appliances. Any comments made in this regard are from a general observation only.

PAINTWORK - The condition of painted surfaces is often a subjective matter. Areas that appear to be acceptable when furnished may not always be considered so when devoid of obstructions. Paint work is normally not considered in Property Inspections. To prevent wood decay of timber surfaces and deterioration of metal components, the condition of these surfaces should be monitored, and repainting carried out regularly. Corrosion of any metal roof sheeting should be repaired, treated and painted to avoid water leakages. Painted surfaces can mask areas where timber has deteriorated. Our visual inspection may not detect instances where this has occurred. The opinions provided here are of a general nature only, given that there can be significant differences in the condition of painted surfaces in each area of the property. The reader of this report is urged to conduct their own detailed inspection before reaching a conclusion regarding the acceptability of painted surfaces

PATHS, PAVING & DRIVEWAY - Cracking, movement, uplifting, sinking, alignment, roof penetration.

SPECIAL PURPOSE REPORTS - Improvements such as swimming pools and spas are subject to a Special Purpose Report and are not included in our inspection and reports. We recommend that a qualified technician be engaged to report on these items and to advise on current regulations relating to safety fencing and equipment.

STAIRCASES - Stringers, handrails, balustrades, newel posts, treads (goings), risers

SUB FLOOR - Dampness, debris, drainage, ventilation, cracked or leaking pipes; **TIMBER CONSTRUCTION**: bearers & joists, framing, piers/stumps; **SUSPENDED CONCRETE FLOOR CONSTRUCTION**: concrete condition, cracking. If moisture is noted, it is recommended that the sub-floor area be monitored to ensure that surface and sub-surface moisture ingress is not an ongoing issue. If the area remains damp, consideration should be given to upgrading subterranean and surface drainage systems to ensure that moisture is directed away from the building foundations and the sub-floor area is kept dry. A qualified drainage expert should be consulted with regard to drainage issues.

Foundation problems are caused by reactive soil types and trees and gardens being planted too close to the building. Generally, clay soils which are common in the ACT, are reactive soils. Large trees use vast amounts of water and can quickly draw moisture out of the ground during dry periods, this results in destabilised moisture content of the soils around the building and ultimately may cause a foundation problem. Over watering gardens close to the building may have the opposite effect, especially with clay soil. Over watering increases the moisture content of the soil which can result in "heaving" of the foundations adjacent to the garden. When watering close to the building you should avoid 'pooling' of water in a particular area, as this also affects the moisture content of the soil which in turn can cause damage to footings and foundations. Too much or too little water near the perimeter of the building may cause serious problems with foundations and footings and damage can cause major structural problems, resulting in costly repairs.

HINTS FOR AVOIDING PROBLEMS AND COSTLY REPAIRS:

- Water gardens evenly close to the building and do not over water
- Ensure the ground is graded away from the walls of the building and that the property has adequate drainage
- Promptly repair broken downpipes, leaking taps, sewerage pipes and other water services
- Hot water system overflows should be directed away from the area immediately adjacent to the foundations and the services maintained to ensure excessive leakage does not occur
- Garden beds should not be located against the house

TIMBER PESTS - Our visual inspection is undertaken to identify the following timber pests: Subterranean termites, Borers, Timber decay (rot) fungi. Where applicable and where there is reasonable access, the following areas are examined: interior and exterior of structures, roof cavity, subfloor, garage or carport, garden and storage sheds/outbuildings, retaining walls and garden borders, pergolas and decks, structures, fences and trees within 30m of the building within the boundaries of the property. Water leaks: especially in the subfloor or against external walls e.g. leaking taps, roofs or down pipes, increases the likelihood of termite attack. Leaking showers or leaks from other 'wet areas' also increase the likelihood of concealed timber pest attack. Where evidence of termite activity was found in the grounds then the risk to buildings is very high. A treatment to eradicate the termites and to protect the building(s) should be immediately carried out. Where the evidence of termite workings (including dormant mud leads) was found in the grounds or the building(s) then the risk of a further attack is very high. If live termites or any evidence of termite workings or damage was reported within the building(s) or in the grounds and fences then it must be assumed that there may be concealed termite activity and/or timber damage. This concealed activity or damage may only be found when alterations are carried out such as when wall linings, cladding or insulation are removed or if you arrange for an invasive inspection. In situations where visual evidence of termite activity or damage is reported, but no live termites were observed during the inspection, it's important to recognise that termites might still be active in the immediate vicinity, potentially causing further damage. Determining whether the infestation is active or inactive requires multiple inspections over time, as various factors, such as prior disturbances, climatic conditions, or the termites finding an alternative food source, can influence their presence during a single inspection. To safeguard against potential termite-related issues, we recommend continued, regular inspections. **An invasive inspection is also an option for a more comprehensive assessment. We strongly encourage the property owner to consider implementing a Timber Pest Preventative Management Plan, which includes periodic Termite Inspections. This proactive approach will help ensure the ongoing protection of the property against potential termite threats. Please call our office on 6288 0402 for information and to arrange a customised schedule for this building or contact your regular inspector.**

WALL CONSTRUCTION - Distortion (significant), nail popping, defective lining, dampness/water damage, cracking, defective or damaged plaster/render. Settlement cracks, if present, need to be monitored over a period of time to determine if an ongoing structural problem exists. If any reference has been made in this report to cracking, settlement and/or movement, it should be noted that we are not experts in this area and further advice should be obtained from a Structural Engineer.

WATERPROOFING - A VISUAL INSPECTION OF THE AREA CANNOT PROVIDE CONCLUSIVE EVIDENCE THAT THE AREA IS WATERPROOF. Compliance with Australian Standard AS 370-2004 Waterproofing of Wet Areas is critical to meeting waterproofing requirements. Should conclusive evidence be required regarding the integrity of waterproofing of wet areas, in particular shower areas, we recommend that a qualified technician be engaged to complete a comprehensive test to include:

- Capping the shower rose and leaving the water reticulation system under pressure and then checking for evidence of water leakage around tap spindles etc. (the sound of escaping air when the shower rose cap is removed indicates a watertight system). The technician may be engaged to complete a comprehensive pressure test of the entire water reticulation system.
- Plugging the floor drain of the shower cubicle and filling the base with water to the maximum level. Allowing the water to remain in the base for an extended period and checking that the level has not dropped. If the water has diminished it is most likely that the waterproofing system has failed.

WET AREAS - Fixtures and fittings, ventilation, cistern/pan, taps, basins, tubs, leakage, sealants, drummy/cracked/missing tiles, grout defects, vanity, shower leakage, broken/cracked glass. If a wet area was not in service prior to and or at the time of inspection and no elevated moisture readings were recorded, or there was no visible evidence of current water leakage, then it is possible that an existing water leak will remain undetected.

WINDOWS - Putty/glazing sealant, broken glass, rotting frames (timber), corrosion (metal), sills, fittings/hardware, damage. In most cases access to windows is restricted by window treatments, furniture or security locks. Older style timber windows can sometimes bind with the frame. This is viewed as a general maintenance issue. Sash windows sometimes require maintenance to the window balance mechanism or sash cords. A visual inspection cannot provide a guarantee that windows will operate smoothly. Sometimes window runners, sashes and balance mechanisms will require maintenance or replacement.



SAFETY & REASONABLE ACCESS

Australian Standard 4349.1 – 2007 3.2.2 The extent of accessible areas shall be determined by the inspector at the time of inspection, based on the conditions encountered at the time of inspection. The inspector shall also determine whether sufficient space is available to allow safe access. The inspection shall include only accessible areas and areas that are within the inspector's line of sight and close enough to enable reasonable appraisal. The Australian Standard 4349.3 defines reasonable access as "areas where safe, unobstructed access is provided and the minimum clearances are available; or, where these clearances are not available, areas within the consultant's unobstructed line of sight and within arm's length. NOTE: Reasonable access does not include removing screws and bolts to access covers." Reasonable access is determined in accordance with the provisions of the following WHS requirements;

Area	Access Manhole MM	Crawl Space MM	Height
Subfloor	500 x 400	VERTICAL CLEARANCE - Timber Floor: 400* Concrete Floor: 500	Height
Roof Interior	400 x 500	600 x 600	Accessible from a 3.6 m ladder
Roof Exterior			Accessible from a 3.6 m ladder

** To underside of bearer, joist or other obstruction to access.*

ROOF COVER INSPECTION

Work Health and Safety requirements determine that an inspector accessing a roof cover must be protected by harnessed safety lines and or edge protection. These safety measures are not practical during a presale inspection, therefore, this report is restricted to a "top-of-ladder" inspection. This report is not a guarantee that defects and/or damage do not exist in any part of the property not specifically seen and described by the inspector. This report is not a warranty against problems that may develop in the future.

CEILING CAVITY INSPECTION

Work Health and Safety requirements determine that an inspector entering a ceiling cavity or similar space must have direct access to properly constructed walkways (sometimes referred to as catwalks) to eliminate the possibility of falling through the ceiling lining to the floor below, a fall that could result in serious injury. Generally, walkways are limited in a ceiling cavity so invariably sections of the roof structure will be inspected from a distance with the inherent limitations associated with limited access and often an impaired line-of-sight. Safety requirements prevent the inspector from traversing a ceiling cavity where safety elements are not available. This report is not a guarantee that defects and/or damage do not exist in inaccessible areas.

WORK HEALTH & SAFETY ACT 2011

A non-residential building and the common property of some group residential buildings will fall within the definition of a workplace for the purposes of the Work Health and Safety Act 2011. The owners of workplaces must ensure that:

- Premises are safe and without risk
- Plant and substances are used without risk
- Workers are trained in WHS, are aware of their obligations and do, in fact, act in a safe manner

A pre-purchase building inspection may identify some safety issues in the common area but it is not an audit conducted for that specific purpose. It is essential that every Owners' Corporation or Company consult an appropriately qualified specialist to ensure it meets its legislative obligations.

SAFE WORKING TEMPERATURES FOR THE INSPECTOR

When the temperature of a workspace (for example a ceiling cavity) exceeds the level considered to be safe according to WHS guidelines, the inspector will complete a risk assessment and the inspection will be limited accordingly. In the event that the inspector determines that the temperature exceeds safe working limits, generally, the inspection will be limited to the area immediately adjacent to the access for inspection.

PROPERTY REPORT

This report does not and cannot make comment upon: defects which may have been concealed; the assessment or detection of defects (including rising damp or leaks) which may be subject to the prevailing weather conditions; whether or not services have been used for some time prior to the inspection and whether this will affect the detection of leaks or other defects; the presence or absence of timber pests; gas fittings; environmental concerns; the proximity of the property to flight paths, railways, or busy traffic; noise levels; health and safety issues; heritage concerns; security concerns, fire protection; site drainage (apart from surface water drainage). The operation of swimming pools and spas; detection and identification of unapproved building work; detection and identification of illegal or inadequate plumbing or electrical work; durability of exposed finishes; neighbourhood problems; document analysis; any matters solely regulated by statute; any area or item that could not be inspected by the inspector. Unless otherwise specified, no examination has been made of any documentation of any type. We have not referred to statutory authority records nor have we examined any survey or water and sewerage service diagram, or any other document prepared by any statutory authority or other party. Stock images in the report are for presentation purposes only and are not images of the subject property.

PURPOSE OF THE REPORT - The purpose of this report is to identify major defects in the building, decks, pergolas, garages and other similar significant improvements insofar as a property inspector can reasonably identify those defects. Structures, not limited to but including, garden sheds, play equipment, garden trellis, swimming pools and spas are not inspected or included in this report. A Special Purpose Report may be commissioned for these types of improvements. This report contains numerous observations but is not intended to list every defect. Defects are common to all structures and generally are commensurate with the age of the construction and use. Ongoing maintenance, upgrading or replacement requirements, cosmetic works and minor defects or faults are subjective and have not been included.

CONCEALED SURFACES - The inspection did not include breaking apart, dismantling, removing or moving objects, including but not limited to foliage, mouldings, roof insulation or sisalation, floor or wall coverings, sidings, ceilings, floors, furnishings, equipment, appliances, or personal possessions. The inspector cannot see inside walls, between floors, inside skillion roofing, behind stored goods or any other areas that are concealed or obstructed. The inspector did not dig, gouge, force or perform any other invasive procedures. Visible timbers have not been destructively probed or hit. In an occupied property, furnishings or household items may be concealing defects. Some defects may only be visible once furniture and other items have been removed from a property or when alterations are carried out. Built-in cupboards are usually filled with personal items and clothing. Some exterior surfaces may be obscured due to overgrown vegetation. Therefore, we cannot comment on the condition of the surfaces obscured or concealed by these or other items.

WATER PENETRATION & ROOF DRAINAGE - Some water penetration problems and/or dampness within a building do not become apparent and may not be detected unless there has been recent heavy rain or prolonged periods of rain. If moisture has been identified by the inspector using electronic testing equipment, then it will be noted in the report. Roof drainage is not tested. Therefore, no guarantee is given or implied that the roof will remain weatherproof in all weather conditions. If there is reference in the report to water stains within the interior of the property this may be evidence that the roof and or drainage system has previously leaked. We recommend that you contact a suitably qualified roofing expert to discuss the probability of ongoing water leakages in the building. Particularly with respect to older properties and where the roof has a low pitch, engaging the services of qualified roof plumber to provide an expert opinion should be considered. The very best roof drainage systems can fail in extreme weather conditions sometimes impacted by conditions not related to the property under review. (Blocked or impaired stormwater drains for example).

FIRE PROTECTION EQUIPMENT & ORDINANCE REQUIREMENTS - These are not covered by this report and these matters should be checked with the statutory authority. Any fire protection equipment has not been tested, e.g. smoke detectors etc.

HAZARDOUS MATERIALS & CONTAMINATION - Our inspection and report does not cover any hazardous materials or prior use of the land and building or any chemicals applied to land and buildings, which may have caused contamination.

RETAINING WALLS & STRUCTURAL COLUMNS - We are not engineers. Comment in respect of large and/or structural retaining walls and columns are beyond the scope of this report. It is not possible to determine from a visual inspection whether a retaining wall or column has been built in accordance with sound engineering principles and, even if it has, whether it is or will remain sound. An engineer should be consulted in any case where there are large, or structural, retaining walls, columns or similar building elements.

INTERNAL WALLS & CEILINGS - Movement cracking in ceiling and wall linings are common to most structures particularly older developments. Mostly they are cosmetic and generally have no structural implications. Repairation is usually undertaken during routine maintenance. Undulations in ceiling linings are often associated with older structures and are a result of the deterioration of the adhesive used to fix plasterboard to the ceiling battens. Typically, this is a cosmetic defect, however, in some circumstances the plasterboard may require refixing to the battens.

CRACKING/SETTLEMENT/MOVEMENT & STRUCTURAL INTEGRITY - Where reference has been made in this report to cracking, settlement, movement or an opinion has been provided on structural integrity, it is important to note that we are not experts in this area and our advice is limited accordingly. If considered necessary, further advice should be obtained from a Structural Engineer before critical decisions are made. Any cracking reported should be monitored for further movement. If further movement is noted, a Structural Engineer should be consulted at the earliest opportunity. Cracking of masonry walls is very common in the ACT, particularly where there are volatile clay soils. There may be some superficial or hairline cracks that we consider have no structural implications which have not been identified.

ELECTRICAL, GAS & OTHER SERVICE INSTALLATIONS - We are not licensed electricians, gas fitters or mechanical engineers. This report does not cover any matters relating to electrical and gas installations or any apparatus operated by electronic, mechanical or hydraulic means. This report does not cover any matters relating to the operation of electrical or gas appliances. Any comments made in this regard are from a general observation only. You should satisfy yourself as to the operation and condition of any appliances or other installations. Any comments made in this regard are from general observation only. There has been no electrical, data, security or fire detection system testing or investigation.

PLUMBING & DRAINAGE - We are not licensed plumbers and a specialist inspection of the water service, plumbing and drainage system including roof drainage is excluded from this report. We recommend an inspection by a licensed plumber and drainer to identify any plumbing faults or drainage problems.

TIMBER PESTS - If this report does not include one, we strongly recommend that an independent inspection and report be obtained from an accredited Pest Inspector to determine whether the property is free from infestation (whether active or dormant).

BOUNDARIES - Unless otherwise stated, the inspector has not gained access to any neighbouring properties and is therefore unable to comment upon the external state of any boundary fences and walls. The common areas of unit developments are not inspected. Any comments made in relation to common areas are strictly observational.

RURAL PROPERTY INSPECTION - This inspection and report relates to the residential structure; rural improvements on the property are not inspected or reported on, any comments contained in this report relative to rural improvements are strictly observational.

AREAS AND DIMENSIONS - Whilst every care has been taken to accurately quantify dimensions referenced in this report, we accept no responsibility for inaccuracies as supplying this information exceeds the requirements of a standard building inspection as per Australian Standard 4349.1-2007. In many instances scale plans are not available and therefore the reader should not rely on this report when making critical decisions relating to dimensions.

ELEVATED STRUCTURES - Where reference has been made in this report to an elevated structure such as a deck balcony or veranda, it is important to note that we are not Structural Engineers and accordingly our advice is limited. Any opinion relating to structural integrity is relative to weight loadings typical of a normal household event. Prior to loading the structure beyond normal, which may occur at a larger gathering, we recommend that professional advice be obtained to determine that the structure will safely cope with the weight loading. Additionally, the structure should be regularly inspected to ensure that structural integrity is maintained.

SPECIAL PURPOSE REPORTS - This Property Report does not contain any assessment or opinion in relation to any item which is the subject of a Special Purpose Property Report, or any matter where the inspection or assessment of which is solely regulated by Statute. Special Purpose Property Reports include comment on the following: common property areas, environmental concerns such as sunlight, privacy, streetscape and views, proximity of property to flight paths, railways and busy traffic or other neighbourhood issues; noise levels; WHS issues including, but not limited to the presence of asbestos, lead or other hazardous materials; heritage concerns; security or fire protection systems; climate control or water heating systems; analysis of site drainage apart from surface water drainage; swimming pools and spas; detection and identification of illegal and unauthorised plumbing work; durability of exposed finishes.

COMPLIANCE REPORT

The information within this report relies on the plans, survey reports, certificates of occupancy and other relevant documents supplied by the Environment & Planning Directorate (EPD), the appropriate local council or Directorate, the client or their agent. Our company or its employees are not responsible for any omissions or errors where incomplete, inaccurate or illegible information is supplied. It is the responsibility of the property owner to resolve any file discrepancies with the relevant authority. Documentation of any plumbing or electrical alterations is not included in the building file. If required, this documentation can be obtained by the title holder from the relevant utilities provider. If the subject property features a second driveway or verge crossing, Transport Canberra & City Services approval may be required. This information is not supplied in the building conveyancing file. If this report confirms that certification is 'pending' for an unapproved structure, it is important that you are aware that this process can take weeks and involve more than one agency including but not limited to the Environment & Planning Directorate, Icon & Transport Canberra & City Services. Whilst it is rare, in some instances throughout the approvals process an application may be rejected. The Compliance Report relies on documentation provided in the Building File. Residential Reports Inspectors are not Building Surveyors. Certifications included in the file are not cross referenced with the Building Code of Australia (BCA) applicable at the time of construction to confirm that the improvements are compliant with the BCA. This is the responsibility of the Building Surveyor prior to issuing a Certificate of Occupancy. No attempt is made in this inspection and reporting process to confirm that the existing improvements on the subject property are in strict accordance with approved plans. There may be variations in design, features and dimensions that conflict with each other. Additionally, there is no guarantee given that improvements are in accordance with the current Building Code of Australia. In most circumstances, there is no requirement to upgrade specifications to the current Building Code.

SWIMMING POOLS & SPAS - The ACT Government has introduced reforms to home swimming pool safety, with a focus on swimming pool safety barriers. The reforms commence on 1 May 2024, with a four-year transition period. The scheme imposes requirements for information about the safety standard of a regulated swimming pool to be disclosed on the sale of a property. Owners must provide prescribed information including: exemption certificate, compliance certificate, swimming pool disclosure statement, certificate of occupancy for the pool and safety barriers that is not older than 5 years and 'Pool Owners Guidance Material' which outlines the obligations on owners of premises on which a regulated swimming pool is located. If this information is not provided in this report, you must request a copy. For more information on the reforms visit the ACT Government's Planning website.

TIMBER PEST REPORT

This report is the result of a VISUAL INSPECTION ONLY. Inspection of the property and this report has been completed with reference to AUSTRALIAN STANDARD AS 4349.3 - 2010 Inspection of buildings Part 3: Timber Pest Inspections. In all instances throughout this report the inspector is referring to accessible areas only. Areas that were not accessible at the time of inspection or were concealed from view are not covered by this report. The inspector does not imply that inaccessible or partly inaccessible areas of the property were not, or have not been, infested by Timber Pests. This Report is not a guarantee that an infestation or future infestation and/or damage does not exist in any inaccessible or partly inaccessible areas of the property. This inspection DID NOT include breaking, removing or moving objects, floor and wall coverings, roof insulation, foliage, furniture, appliances stored goods and personal possessions - these all limit the scope of inspection. The inspector does not have access to the inside of walls, between flooring, inside eaves and skillion roofing. This Report is confined to reporting infestation and/or damage caused by white ants (subterranean and damp wood termites), borers of seasoned timber and timber pests (wood decay fungi), present on the date of the Inspection. The Inspection did not cover any other pests and this Report does not comment on them. Dry wood termites and European House Borer (*Hylotrupes bujulus* Linnaeus) are excluded from the inspection due to the extreme difficulty in locating the small colonies. Some species of termite and house borers, if discovered, will be reported (by law) to Government Authorities.

TERMITE RECOMMENDATIONS - Where evidence of termite activity or workings was found in any structure then the risk to buildings is very high and the risk of further attack is also high. A treatment to eradicate the termites and to protect the building(s) should be carried out. If live termites or any evidence of termite workings or damage was reported within the building(s) or in the ground and fences then it must be assumed that there may be concealed termite activity and/or timber damage. This concealed activity or damage may only be found when alterations are carried out such as when wall linings, cladding or insulation are removed or if you arrange for an invasive inspection. We claim no expertise in engineering or building. We strongly recommend that you have a qualified person such as a Builder, Engineer, Architect or other qualified expert in the building trade determine the full extent of the damage, if any. This may require an invasive inspection. We take no responsibility for the repair of any damage whether disclosed by this report or not.



Where visual evidence of termite workings and/or damage is reported but no live termites were present at the time of inspection, you must realise that it is possible that termites are still active in the immediate vicinity and the termites may continue to cause further damage. It is not possible, without benefit of further investigation and a number of inspections over a period of time, to ascertain whether any infestation is active or inactive. Active termites may simply have not been present at the time of inspection due to a prior disturbance, climatic conditions, or they may have been utilising an alternative feeding source. Continued, regular, inspections are essential. Unless written evidence of a termite protection program in accord with "Australian Standard 3660" with ongoing inspections is provided, you must arrange for a treatment in accord with the standard to be carried out immediately to reduce the risk of further attack.

Where the evidence of live termite or termite damage or termite workings (mudding) was found in the building (s) then the risk of a further attack is very high. Where evidence of live termites or termite damage or termite workings was found in the grounds but not in the buildings then the risk to buildings is very high.

If evidence of drill holes in concrete or brickwork or other signs of a possible previous treatment is reported then the treatment was most likely carried out because of an active termite attack. Extensive structural damage may exist in concealed areas. You should have an invasive inspection carried out and have a builder determine the full extent of any damage and the estimated cost of repairs as the damage may only be found when wall linings etc are removed. Normally if a termite treatment has been carried out then a durable notice should be located in the meter box indicating the type of termite shield system, treated zone or combination has been installed.

BORER RECOMMENDATIONS - Borer activity is usually determined by the presence of exit holes and/or frass. Since a delay exists between the time of initial infestation and the appearance of these signs, it is possible that some borer activity may exist that is not discernible at the time of inspection. If borers are identified replacement of all susceptible timbers is always preferred since, in the event of selling the property in the future it is probable that an inspector will report the borers as active. A chemical treatment to control and/or protect against Furniture beetle and/or Queensland pine beetle can be considered as a less effective, lower cost option. Before considering this option You should consult with a builder to determine if the timbers are structurally sound. Following the initial treatment, a further inspection is essential in twelve months' time to determine if further treatment is needed. Treatments over a number of consecutive years may be required. The *Lyctus brunneus* (powder post beetle) is not considered a significant pest of timber. Damage is confined to the sapwood so treatment or timber replacement is not usually required. However, you should have a building expert investigate if any timber replacement is required. *Anobium punctatum* (furniture beetle) and *Calymnaderus incisus* (Queensland pine beetle) must always be considered active, unless proof of treatment is provided, because, unless the timber is ground up, one cannot determine conclusively if activity has ceased. Total timber replacement of all susceptible timbers is recommended. A secondary choice is treatment. However, the evidence and damage will remain, and the treatment may need to be carried out each year for up to three years.

HIGH MOISTURE READINGS, DRAINAGE & VENTILATION - High moisture readings can be caused by any one of the following: poor ventilation, ineffective drainage, leaking pipes, leaking roofs, defective flashing or by concealed termite activity. The areas of high moisture should be investigated by way of an invasive inspection. High moisture levels also increase the likelihood of termite attack and may also be conducive to borer activity and wood decay. If high moisture was reported then you must have a building expert investigate the moisture and its cause and determine the full extent of damage and the estimated cost of repairs.

If drainage is considered inadequate, a plumber or other building expert should be consulted, and remedial measures should be taken. Ventilation of the sub-floor region is important in minimising the opportunity for subterranean termites to establish themselves. Consideration should be given to installing high air flow vents and/or improve the cross flow of air within the subfloor to produce ventilation equivalent to 8400 sq mm net ventilation area per lineal metre on external and internal walls.

INFILL AND CONCRETE SLABS - Any building or part of a building that is constructed on a concrete slab is always more susceptible to termite attack because of possible concealed termite entry. A very high proportion of termite attacks are over the edge of both infill and other concrete slab types. If the edge of the slab is concealed by concrete paths, patios, pavers, garden beds, lawns, foliage, etc then it is possible for termites to conceal their entry into the property. Termites can then cause extensive damage to concealed framing timbers. Even the most experienced inspector may be unable to detect their presence due to concealment by wall linings. Only when the termites attack timbers in the roof void, which may in turn be concealed by insulation, can their presence be detected. Infill slab type construction has an even higher risk of concealed termite ingress as the slab edge is concealed due to the construction design and is not exposed. The type of slab may only be determined by assessment of the construction plans by a qualified person such as a Builder, Certifier or Architect. Construction Plans may be obtainable by your conveyancer. Termite activity and or damage may be present in concealed timbers of the building. We strongly recommend frequent regular inspections

in accordance with AS 3660.2. Where the slab edge is not fully exposed, or the slab is an infill slab or the slab type cannot be determined then we strongly recommend inspections every 3 to 6 months in accordance with AS 3660.2. Infill slab: A slab on the ground cast between walls. Other slabs should be in accordance with AS 2870 - 1996 and AS 3660.1-2000.

TIMBER (FUNGAL) DECAY - We claim no expertise in building and if any evidence of fungal decay or damage is reported you should consult a building expert to determine the full extent of damage and the estimated cost of repairs or timber replacement.

DETERMINING EXTENT OF DAMAGE - This Report is NOT a structural damage report. You agree that we are not responsible or liable for the repair of any damage, whether disclosed by our report or not. Our inspectors are not necessarily specialised builders and any inexperienced opinion provided with respect to timber damage cannot be relied upon. The Report will not state the full extent of any timber pest damage; rather, we may provide comment on the damage for your information. If evidence of Timber Pest activity and/or damage is reported in the structure(s) or the grounds of the property, then you must assume that there may be further concealed structural damage within the building(s). This concealed damage may only be found when invasive procedures are applied to reveal previously concealed timbers. In the case of Timber Pest activity and/or damage WE STRONGLY RECOMMEND an invasive Timber Pest Inspection is undertaken and a qualified person such as a Builder, Structural Engineer, or Architect be engaged to carry out a structural inspection to determine the full extent of the damage and repairs that may be required.

MOULD - Mould (also referred to as Mildew and non-wood decay fungi) is not considered a Timber Pest. This report does not extensively cover the inspection of Mould. If evidence of mould was observed during the inspection, it may be noted for your information. If you are concerned as to the possible health risk resulting from the presence of mould, then you should seek advice from your local State or Commonwealth Government Health Department expert.

IMPORTANT INFORMATION

This Report reflects the condition of the property existing at the time of the inspection date and may not reflect the current state. Timber Pests, particularly termites, may have gained entry to the property since the inspection date. Termites can, in a relatively short period, cause significant damage to both structural and non-structural timbers within and around the buildings of the property. Termites are difficult to detect and much of the damage caused may not be readily visible, if damage exists, it may be costly to repair. If the Report indicated the presence of termites, termite damage, previous activity or treatments, or recommends a treatment, you should obtain copies of the treatment proposal, any certificates of treatments carried out, details of all repairs including copies of quotations, invoices and any other reports. It is strongly recommended that you arrange for an inspection in accordance with AS 4349.3 to verify that the treatment has been successful and carried out in accordance with AS 3660.2 and arrange for a further building inspection in accordance with AS 4349.1. The person carrying out the inspection and this company will have no liability to you for any damage or loss you may suffer as a result of your entering the contract to purchase the property or in connection with completing the purchase of the property as a result of your failure to heed the advice given in this report and may use such failure in defence of any claim that you may later make against any of them.

Where a property is furnished at the time of inspection, you will appreciate that the furnishings, floor coverings and stored goods may be concealing any evidence of Timber Pest Activity which may only be revealed when the items are moved. Where fences are obscured by foliage, overgrowth or structures, evidence of timber pest activity or damage may be concealed. Poor subfloor drainage increases the likelihood of termite attack. If the risk factor stated in this report is high, this is the opinion of the inspector and should encourage awareness that increased vigilance is warranted and that recommendations for the reduction of unfavourable conditions that increase the chances of termite activity must be strictly observed. It is strongly recommended that a comprehensive timber pest inspection by a qualified timber pest inspector is undertaken every 6-12 months (or more frequently if specified in the report). Regular inspections DO NOT prevent timber pest attack. Regular inspections increase the chance of the early detection of timber pest activity thereby limiting the structural damage that may occur. The overall degree of risk of Timber Pest Infestation cited in this report is a subjective assessment by the inspector at the time of the inspection, taking into account many factors which include, but are not limited to, location and proximity to bushland and trees and/or other timber structures, evidence of timber pest damage or activity close to the inspected structure or within the inspected structure, conducive conditions that raise the potential of timber pest attack, such as timbers in contact with soil, inaccessible areas, slab on ground construction, or other factors that, in the inspector's opinion, raise the risk of future timber pest attack.

A more thorough INVASIVE INSPECTION is available. Where any current visible evidence of Timber Pest activity is found it is strongly recommended that a more invasive inspection is performed. Trees and stumps on the property with a diameter in excess of 100mm have been visually inspected for evidence of termite activity to a height of 2m where access was possible and practical. It is very difficult, and generally impossible to locate termite nests since they are underground and evidence in trees is usually well concealed. We therefore strongly recommend that you arrange to have trees test drilled for evidence of termite nests.

RESOURCE LIBRARY

Where reference is made to the Residential Reports Resource library, [you may access this content by clicking here.](#)

QUICK FACTS

- Sellers of residential properties are required to provide an Energy Efficiency Rating (EER) to potential buyers. (This is known as mandatory energy efficiency disclosure.)
- The EER forms part of the Sale Contract and must be published in all advertising material.
- The EER rating system uses computer simulations to assess the potential thermal comfort of your home.
- The more stars, the less likely the occupants need cooling or heating to stay comfortable.
- The ACT Government has two systems in place for Energy Ratings:

One is for established homes
(1st Generation Software)

One is for new homes
(2nd Generation Software)

Residential Reports (and all other companies preparing reports for the sale of a property on an existing Canberra home that has been previously occupied) are required to use 1st Generation Software.

- The consumption of energy in the home for heating, cooling, hot water or lighting and other appliances IS NOT considered in the application of 1st generation software when calculating the EER rating.
- Many aspects of solar passive designs are also not able to be accounted for in 1st Generation Software.

WHAT IS RATED?

The rating is dependent on:

- Layout of the home
- Construction of its roof, walls, windows and floor
- Wall, floor and ceiling insulations
- Orientation of windows and shading of the sun's path and local breezes
- Influence of the local climate

WHY IS THERE A DISCREPANCY BETWEEN MY OLD EER AND MY NEW EER?

- Increasingly, in a number of circumstances particularly where new homes have been rated using 2nd generation software and are now being offered for sale where the rating must be conducted using 1st generation software, there can be a significant variation between the two ratings:

1st generation software rates to 6 stars

2nd generation software may rate up to 10 stars

- ACT Legislation currently PROHIBITS Inspectors from assuming insulation values which may have been the case previously. Documented proof or visual sighting is now required to verify the existence and rating of insulation.

Your Energy Rating is calculated using software approved by the ACT Government.

Certificate of Currency

Policy Number	BP20200022
Item 1 The Insured:	Residential Reports Pty Ltd
Item 2 Address:	35 Poynton Street HUGHES ACT 2805
Item 3 Professional Services covered by this policy:	Pre Purchase Building Inspections (AS4349.1) Special Purpose Building Inspections Energy Rating Reports Urban Pest Management Termite Management including inspections - existing buildings and structures (AS3880.2) Timber Pest Inspections (AS4349.3)
Item 4 Description of the Policy:	Professional Indemnity & Broadform Liability (CGU PIB 03-17)
Item 5 Period of Insurance:	From 20/07/2025 To 4.00 pm on 20/07/2026
Item 6 Particulars of Risk:	
	<u>Civil Liability Professional Indemnity</u>
6.1 The Policy Limit is	\$5,000,000 which includes all policy sections
6.2 The Policy Excess is	\$20,000
6.3 The Retroactive Date is	20/07/2020
	<u>Public Liability</u>
6.4 Sum Insured	\$20,000,000
6.5 Excess	\$2,500
Date and Place of Issue	21/07/2025 Melbourne, Victoria

Signed for and on behalf of Insurance Australia Limited ABN 11 000 016 722



Najibi Blisso, Manager

This Certificate of Currency indicates policy cover effective as at the date of issue only

FirstRate Report



YOUR HOUSE ENERGY RATING IS: ★★
in Climate: 24

2 STARS

SCORE: -42 POINTS

Name: J Stirling & M Scott

Ref No: 46947

House Title: Block 5, Section 61

Date: 18-05-2026

Address: 9 Stuckey Place

Charnwood

2615

Reference: C:\REPORTS\...\STUCKEY PLACE CHARNWOOD 9

IMPROVING YOUR RATING

The table below shows the current rating of your house and its potential for improvement.

Star Rating	POOR			AVERAGE				GOOD				V. GOOD
	0 Star	★	★★	★★★	★★★★	★★★★★	★★★★★★	★★★★★★★	★★★★★★★★	★★★★★★★★★	★★★★★★★★★★	
Point Score	-71	-70	-46	-45	-26	-25	-11	-10	4	5	16	17
Current	-42											
Potential	30											

Incorporating these design options will add the additional points required to achieve the potential rating shown in the table. Each point represents about a 1% change in energy efficiency. This list is only a guide to the range of options that could be used.

Design options

Additional points

Change added wall insulation	R 2.5	43
Change added floor insulation	R 2.5	11
Change glass to Double Glazing	100 %	7
Change curtain to	Heavy Drapes & Pelmet	11

FirstRate Mode
Climate: 24

RATING SUMMARY for: Block 5, Section 61, 9 Stuckey Place, Charnwood

Assessor's Name: Lindsay Collison

				Points		
Feature				Winter	Summer	Total
CEILING				5	1	6
Surface Area:	0	Insulation:	6			
WALL				-42	0	-42
Surface Area:	-21	Insulation:	-21	Mass:	0	
FLOOR				-3	0	-3
Surface Area:	0	Insulation:	-3	Mass:	0	
AIR LEAKAGE (Percentage of score shown for each element)				4	0	4
Fire Place	0 %	Vented Skylights	0 %			
Fixed Vents	0 %	Windows	29 %			
Exhaust Fans	7 %	Doors	53 %			
Down Lights	0 %	Gaps (around frames)	11 %			
DESIGN FEATURES				0	1	1
Cross Ventilation	1					
ROOF GLAZING				-1	-3	-3
Winter Gain	1	Winter Loss	-2			
WINDOWS				-12	-7	-19
Window Direction	Area		Point Scores			
	m2	%NCFA	Winter* Loss	Winter Gain	Summer Gain	Total
N	5	5%	-9	9	0	0
E	5	5%	-11	6	-1	-6
S	3	3%	-1	0	0	-1
W	9	10%	-16	10	-6	-12
Total	22	22%	-38	26	-7	-19

* Air movement over glazing can significantly increase winter heat losses. SEAV recommends heating/cooling duct outlets be positioned to avoid air movement across glass or use deflectors to direct air away from glass.

The contribution of heavyweight materials to the window score is -1 points

			Winter	Summer	Total
RATING	★ ★	SCORE	-49	-8	-42*

* includes 15 points from Area Adjustment

Detailed House Data

House Details

ClientName J Stirling & M Scott
HouseTitle Block 5, Section 61
StreetAddress 9 Stuckey Place
Suburb Charnwood
Postcode 2615
AssessorName Lindsay Collison
FileCreated 18-05-2026
Comments

Climate Details

State
Town Canberra
Postcode 2600
Zone 24

Floor Details

<u>ID</u>	<u>Construction</u>	<u>Sub Floor</u>	<u>Upper</u>	<u>Shared</u>	<u>Foil</u>	<u>Carpet</u>	<u>Ins RValue</u>	<u>Area</u>
1	Timber	Enclosed	No	No	No	Float Timb	R0.0	67.1m ²
2	Timber	Enclosed	No	No	No	Carp	R0.0	43.1m ²

Wall Details

<u>ID</u>	<u>Construction</u>	<u>Shared</u>	<u>Ins RValue</u>	<u>Length</u>	<u>Height</u>
1	Brick Veneer	No	R0.0	45.9m	2.4m

Ceiling Details

<u>ID</u>	<u>Construction</u>	<u>Shared</u>	<u>Foil</u>	<u>Ins RValue</u>	<u>Area</u>
1	Attic - Standard	No	No	R4.0	110.2m ²

Window Details

<u>ID</u>	<u>Dir</u>	<u>Height</u>	<u>Width</u>	<u>Utility</u>	<u>Glass</u>	<u>Frame</u>	<u>Curtain</u>	<u>Blind</u>	<u>Fixed & Adj Eave</u>	<u>Fixed Eave</u>	<u>Head to Eave</u>
1	W	2.1m	1.8m	No	SG	TIMB	HB	Yes	0.6m	0.6m	0.0m
2	W	2.1m	1.8m	No	SG	TIMB	HB	Yes	0.6m	0.6m	0.0m
3	W	2.1m	0.9m	No	SG	TIMB	HB	No	0.6m	0.6m	0.0m
4	E	0.9m	3.3m	No	SG	ALSTD	HB	No	6.5m	0.6m	0.0m
5	N	0.9m	1.6m	Yes	SG	ALSTD	NC	No	4.8m	0.6m	0.0m
6	N	2.1m	1.8m	No	SG	ALSTD	HD	No	4.8m	0.6m	0.0m
7	E	1.2m	1.6m	No	SG	ALSTD	HB	No	0.6m	0.6m	0.0m
8	S	1.0m	0.9m	Yes	SGT	ALSTD	HB	No	0.6m	0.6m	0.0m
9	S	1.0m	1.6m	Yes	SGT	ALSTD	HB	No	0.6m	0.6m	0.0m

Window Shading Details

<u>ID</u>	<u>Dir</u>	<u>Height</u>	<u>Width</u>	<u>Obst Height</u>	<u>Obst Dist</u>	<u>Obst Width</u>	<u>Obst Offset</u>	<u>LShape Left Fin</u>	<u>LShape Left Off</u>	<u>LShape Right Fin</u>	<u>LShape Right Off</u>
1	W	2.1m	1.8m	0.0m	0.0m	0.0m	0.0m	0.0m	0.0m	2.0m	2.2m
3	W	2.1m	0.9m	0.0m	0.0m	0.0m	0.0m	1.9m	0.0m	0.0m	0.0m
4	E	0.9m	3.3m	0.0m	0.0m	0.0m	0.0m	0.0m	0.0m	5.7m	0.0m
5	N	0.9m	1.6m	0.0m	0.0m	0.0m	0.0m	4.0m	1.0m	0.0m	0.0m
6	N	2.1m	1.8m	0.0m	0.0m	0.0m	0.0m	4.0m	3.2m	0.0m	0.0m

Sky Light Details

<u>ID</u>	<u>Dir</u>	<u>Tilt</u>	<u>Type</u>	<u>Shade</u>	<u>Utility</u>	<u>Width</u>	<u>Length</u>
1	E	15 degrees	Double Clear	No	No	1.0m	0.6m
2	E	15 degrees	Double Opal	No	No	0.3m	0.3m
3	W	15 degrees	Double Clear	No	No	1.0m	0.6m

Rater Comments

House Details

ClientName	J Stirling & M Scott
HouseTitle	Block 5, Section 61
StreetAddress	9 Stuckey Place
Suburb	Charnwood
Postcode	2615
AssessorName	Lindsay Collison
FileCreated	18-05-2026

Rater Comments

MEASUREMENTS USED IN THIS ASSESSMENT

The Energy Rating recorded in this assessment is determined by assessing many elements of the structure and interior treatments including window and floor coverings. The area of external walls and windows, ceiling and floors are part of the assessment.

Some measurements used in this assessment may be nominal. Every effort is made by the assessor to accurately calculate the dimensions of property. However, often accurate and comprehensive plans indicating all dimensions of an existing property, particularly following alterations and extensions are not always available. The reader of this report should not rely on the accuracy of any dimensions used when making critical decisions relating to those dimensions. The assessor will not accept any liability should any discrepancy be revealed.

DESIGN OPTIONS

The design option suggestions to improve this energy rating may be additional to elements already in place. For example, the option to install 'Heavy Drapes and Pelmet' will take into account windows that already have Heavy Drapes and Pelmet installed. Insulation recommendations will take into account existing insulation values.

Some recommendations for improvement will not be practical in all circumstances. For example, if the dwelling is built on a concrete slab, it will be possible to install floor insulation.

DOOR SEALS AND WEATHER STRIPS

A wooden framed door is only considered to be sealed when a draft extruding device is fitted to the bottom of the door AND sealing tape or felt is fitting to the timber frame around the door opening.

WINDOW GLAZING RATIOS

Glazing areas in one direction greater than 25% of the nett conditioned floor area will reduce the Energy Efficiency Rating.

CONVEYANCING BUILDING FILE INDEX

SUBURB: **CHARNWOOD** SECTION: **61** BLOCK: **5** UNIT: **N/A** EX GOV: **NO**

COU ISSUED Y/N	PLAN NUMBER	FOLIO NO.	DESCRIPTION OF WORK	AMEND	DETAILS	PERMIT NUMBER	COU PLAN NO. & DATE
N/A	43945	1	(SUPERSEDED)				
		3				43945	
Y	43945/A	4	NEW RESIDENCE				
		21					43945/A 22/02/1977
Y	43945/B	24	BRICK CARPORT				
Y	43945/C	26		Y			
		28				43945/B	
		34					43945/B+/C 29/09/1977
Y	43945/D	36	PERGOLA				
		39				43945/D	
		43					43945/D 14/11/1983

For any incomplete approvals please email acbuildingconveyance@act.gov.au for further information on how to complete.

Drainage Plan Number: 29003

Survey: Y (1)

Comments: PLAN 43945/A USES PERMIT FROM SUPERSEDED PLAN 43945

CONVEYANCING PART 2

No information is provided in respect of electrical, drainage or sewer matters and or to the location of overhead power lines or underground cables in relation to the building.

- | | <u>Yes</u> | <u>No</u> |
|---|--------------------------|-------------------------------------|
| 1. (a) Is this a government or ex government house? | <input type="checkbox"/> | <input checked="" type="checkbox"/> |
| (b) If yes, is there a building file with approvals on it? | <input type="checkbox"/> | <input type="checkbox"/> |
| 2. Is there any record of incomplete building work on the building file?
If yes - file copies attached | <input type="checkbox"/> | <input checked="" type="checkbox"/> |
| 3. Are there any records on the building file of current (within 5 years) housing Indemnity insurance policies for building work? If yes - file copies attached | <input type="checkbox"/> | <input checked="" type="checkbox"/> |
| 4. Are there any records on the building file showing building applications still being processed? (Current within 3 years) If yes - file copies attached | <input type="checkbox"/> | <input checked="" type="checkbox"/> |
| 5. Are there any records on the building file in relation to loose-fill asbestos insulation? | <input type="checkbox"/> | <input checked="" type="checkbox"/> |

If available, copies of the following documents are provided:

- | | | |
|--|-------------------------------------|-------------------------------------|
| • Certificate/s of Occupancy and Use | <input checked="" type="checkbox"/> | <input type="checkbox"/> |
| • Survey Certificates | <input checked="" type="checkbox"/> | <input type="checkbox"/> |
| • Unit Plan/Unit Entitlements (if property is unit titled) | <input type="checkbox"/> | <input checked="" type="checkbox"/> |
| • Approved Building Plans | <input checked="" type="checkbox"/> | <input type="checkbox"/> |
| • Ex- government Building Plans* | <input type="checkbox"/> | <input checked="" type="checkbox"/> |

If requested:

- | | | |
|--------------------|-------------------------------------|--------------------------|
| • Drainage Plan(s) | <input checked="" type="checkbox"/> | <input type="checkbox"/> |
|--------------------|-------------------------------------|--------------------------|

ASBESTOS

The ACT Government is not able to guarantee the accuracy of the information in this report.

You should make your own enquiries and obtain reports (from a licensed Asbestos Assessor) in relation to the presence of loose fill asbestos insulation (and other forms of asbestos) on the premises. For more information go to the Asbestos Awareness Website –

www.asbestos.act.gov.au

Please note: Development Approval plans will not be included in this report (We do not receive Development Approval Plans unless they are part of a Building Approval in which case they become Building Approval Plans), if development approval was granted you can request copies of the Development Approval plans from ACEPDcustomerservices@act.gov.au.

Please Note: Building approvals that have been generated via eDevelopment will be issued with a project number prefixed by the letter B. Initial building approval documentation will be identified with project number B20XXXX only but will be referenced as B20XXXX/A on the Certificate of Occupancy and Use. Any amendments to the original approval will be issued with the project number and an alphanumeric digit. The first amendment will be identified as B20XXXX/B, the second amendment B20XXXX/C etc. Not all eDevelopment plans will be stamped with the plan number.

*Ex Government plans: Plans are typical and not specific to each residence. There may be slight changes to the layout or window locations that were not required to be approved.

Search officer comments (if any?)

Search officer initials: Kayne

Cost of application: \$ 144.79

Date completed:

14/05/2026

C. R. SAMUNDSETT
REGISTERED SURVEYOR



Please address all correspondence to:
P.O. BOX 139, CIVIC SQUARE, A.C.T. 2608

Ref. 5769

20th. August, 1976.

SURVEY REPORT

The Manager,
A.R. Marr Pty.Ltd.,
P.O. Box 203
CIVIC SQUARE. A.C.T. 2608

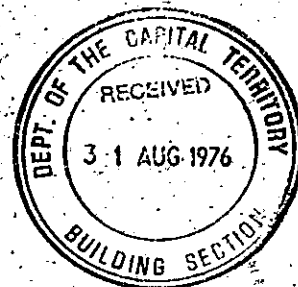

Dear Sir,

Land in the Division of CHARNWOOD, District of Canberra City in the Australian Capital Territory, containing an area of 799 squaremetres, having a frontage of 27.015 metres to Stuckey Place, being BLOCK 5 of SECTION 61 as shown on Deposited Plan No. 3724 and being the land shown edged in red on the sketch opposite.

As instructed I have surveyed the land described above and I find that:-

1. On the land and entirely within its boundaries stand the foundations of a brick residence. The distances from the walls of the dwelling to the boundaries are shown in green on the sketch.
2. The land is unfenced.
3. There are no encroachments on this land nor by this property on the adjoining lands or street.

Yours faithfully,

C.R. Samundsett
Registered Surveyor.

SKETCH

Scale 1 : 500

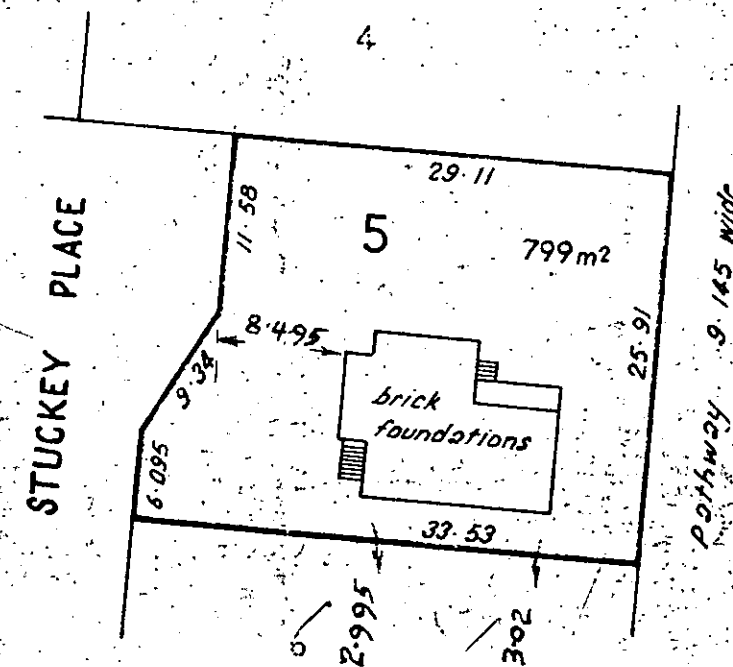

SEC. 61

D.P. 3724

C.R. Samundsett
Registered under the Surveyors Ordinance, 1967.

Department of the Capital Territory
Building Section

Australian Capital Territory
Building Ordinance 1972-74
(Part V)

CERTIFICATE OF FITNESS

(CLASS [redacted] AND X OCCUPANCY ONLY)

BL1/8(9/75)

It is hereby certified that the building consisting of Brick Veneer Residence

..... situated on

Block 5	Section 61	Division Charnwood
or situated at		

for which plans and specifications were approved and a Building Permit issued under the provisions of the Building Ordinance 1972, is fit for use and/or occupation.

Approved plan no. 43945/A		
Type of construction*	Class of occupancy*	Number of storeys
Permit no. 5680.	Name of permit holder A.R. Marr P/L	

*As defined in the Building Manual
A.C.T.

NO

34289

A.F. Boas ✓ 22/2/77
Deputy Building Controller

COLOUR SCHEDULE

- bricks: MULTIBRICKS TAN ANTIQUE, RED ANTIQUE, CREAM ANTIQUE.
 TO BE USED SEPARATELY OR MIXED TO GIVE 6 COMBINATIONS. (BASE & WALL BRICKS TO BE SAME COLOUR).
- windows: BROWN STAINED TIMBER OR BROWN ACRYLIC SLIDING ALUMINIUM.
- tiles: MONIERE 'BARBANA' MID TO DARK BROWN.
- fences: 1500 HIGH STANDARD PALING WITH BRICK PIERS.
- carports: TO MATCH RESIDENCE.

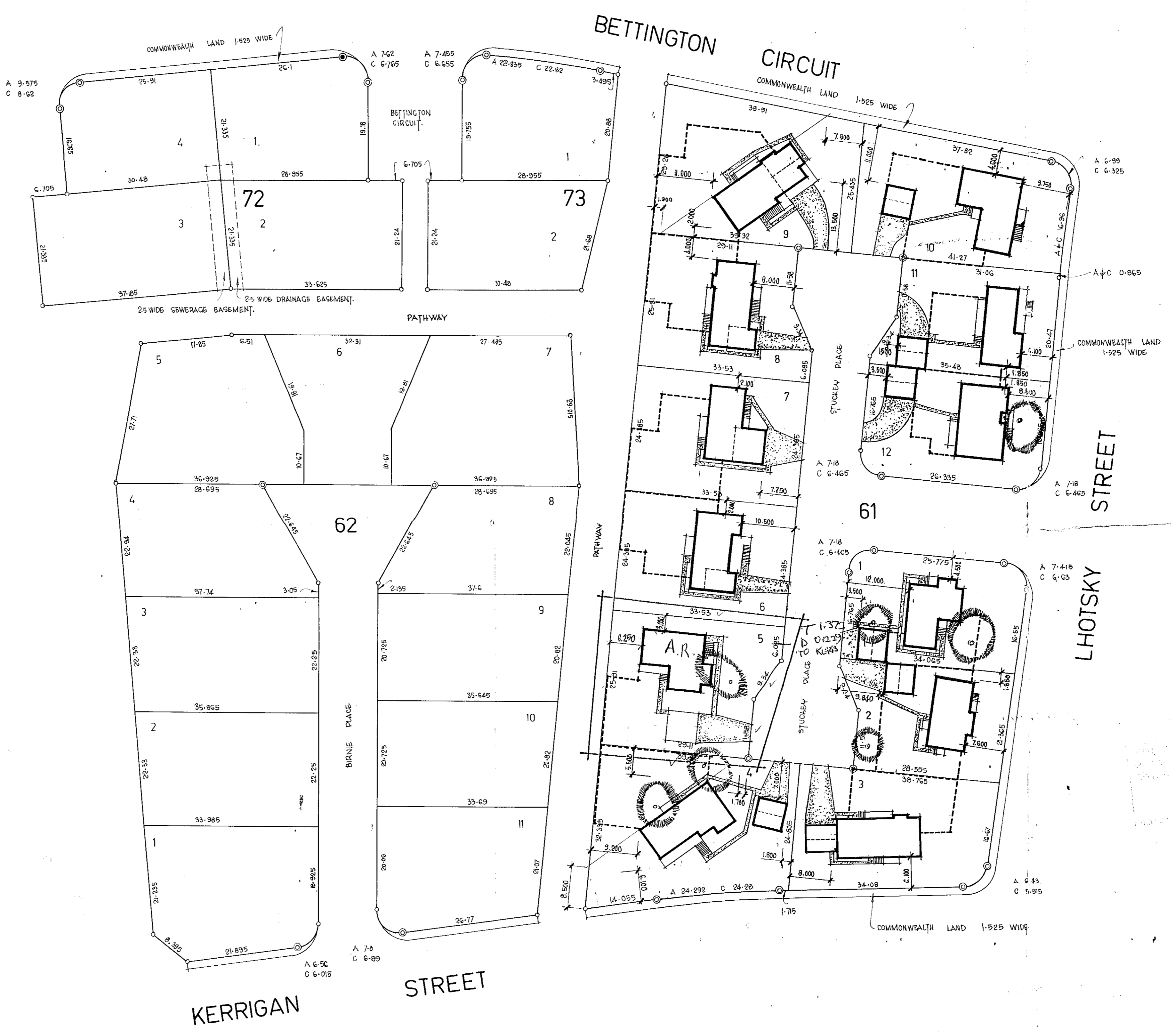
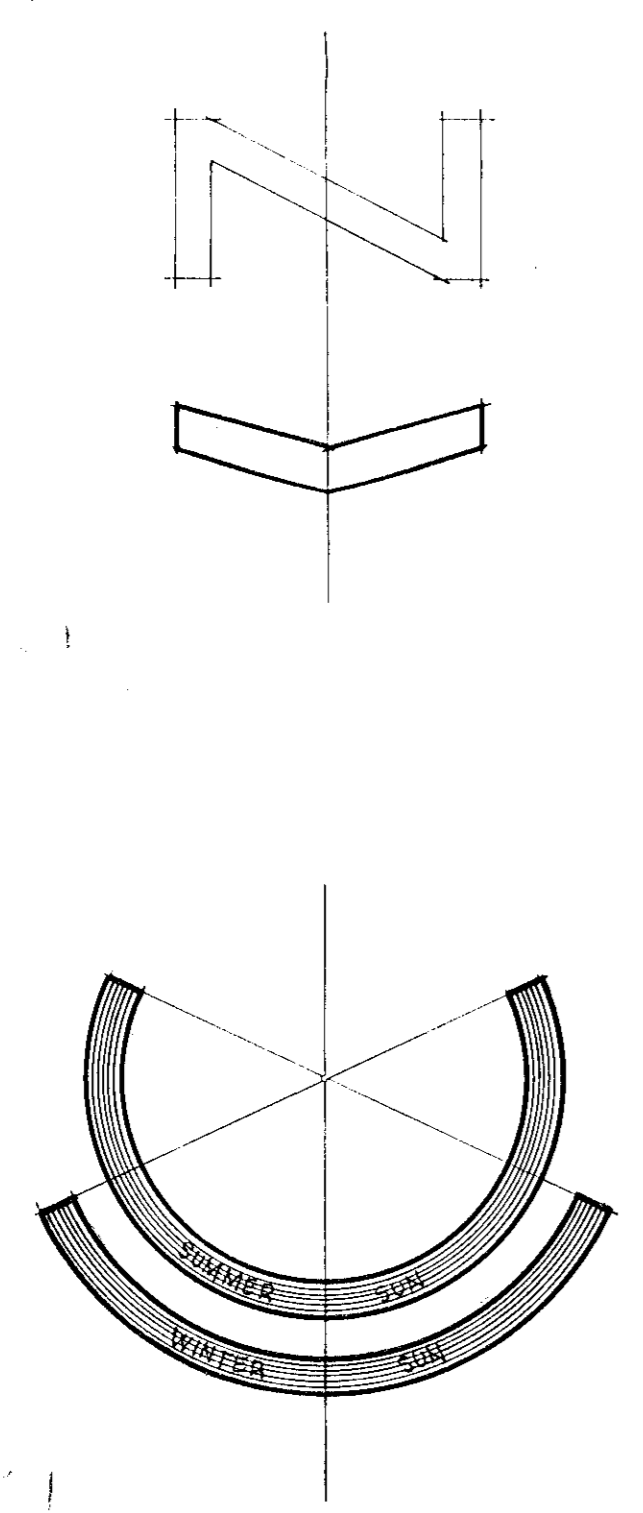

APPROVED SUBJECT TO COMPLIANCE WITH THE CANBERRA SEWERAGE AND WATER SUPPLY REGULATIONS. EXCEPT WHERE SUBJECT TO AND SUPERSEDED BY THE BUILDING MANUAL

PLANS AND SPECIFICATIONS FOR WATER AND SEWERAGE ARE REFERENCED FOR APPROVAL BY
 ENGINEER FOR WATER SUPPLY AND SEWERAGE 25/6/76
 CHIEF ELECTRICAL ENGINEER / /19
 STRUCTURAL ENGINEER / /19
 SENIOR TECHNICAL OFFICER / /19
 APPROVED FOR CONSTRUCTION BY THE HOLDER OF A CLASS LICENSE
 R. J. Riley 25/6/76
 MUNICIPALITY CONTROLLER
 6 sheets 1-6/6

SITE PLAN
 SECTIONS 61, 62, 72, 73
 CHARNWOOD

an
ALAN MARR HOME
 BY
 A.R. MARR PTY. LTD.
 470322 AH 542380
 SCALE
 DRAWN
 DATE

Department of the Capital Territory
Building Section

Australian Capital Territory
Building Ordinance 1972-74
(Part V)

CERTIFICATE OF FITNESS
(CLASS 1 AND X OCCUPANCY ONLY)

BL1/8(9/75)

It is hereby certified that the building consisting of Brick Carport

..... situated on

Block <u>5</u>	Section <u>61</u>	Division <u>Charnwood</u>
or situated at		

for which plans and specifications were approved and a Building Permit issued under the provisions of the Building Ordinance 1972, is fit for use and/or occupation.

Approved plan no. <u>43945/B + 43945/C</u>		
Type of construction*	Class of occupancy*	Number of storeys
Permit no. <u>227</u>	Name of permit holder <u>A. R. Moore</u>	

*As defined in the Building Manual
A.C.T.

NO

116

A. F. B... 29.9.77
Deputy Building Controller

PLANS/FILE No. L2945/B
 Received Building Section
 - 5 JUL 1977 S/12
 Dept. of the Capital Territory

GALV. STEEL TRAY ROOFING TO MANUFACTURER'S SPECIFICATION.

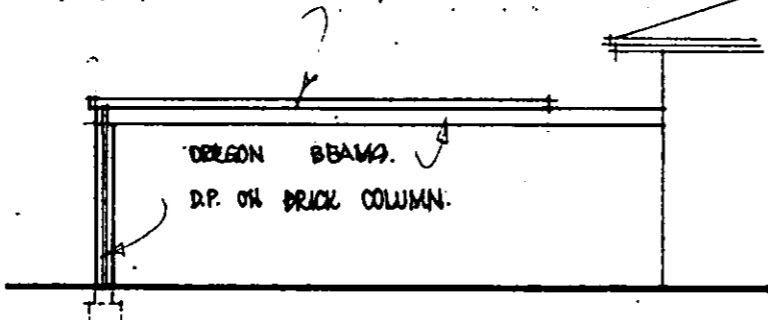

front elevation 1:100

Footings to comply with Part 33 B.M.A.C.T. F&T.M.

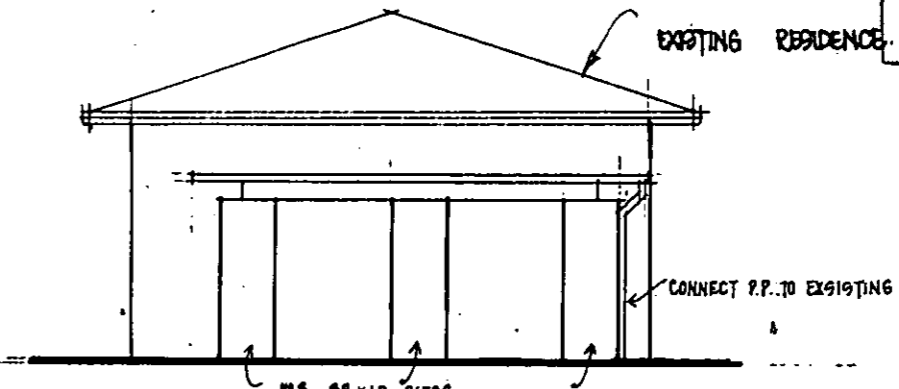

side elevation 1:100

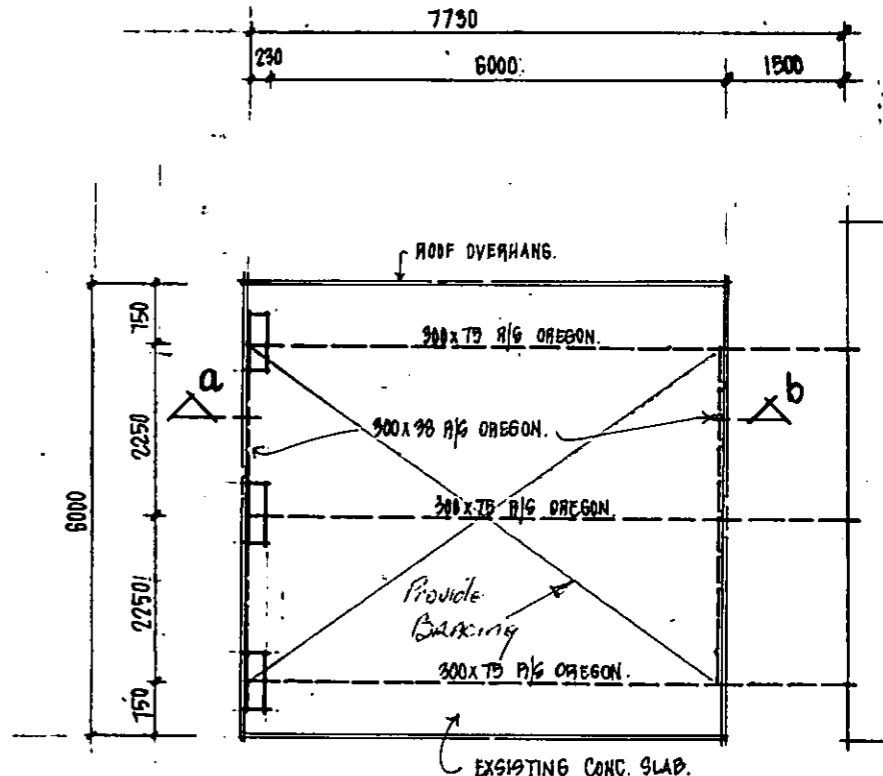

plan 1:100

MIN. 300x320x230 CONC. PAD FOOTING UNDER EACH PIER.
 All work and materials to be confined to the leased area.
 Plans to be lodged with Land Services Section.

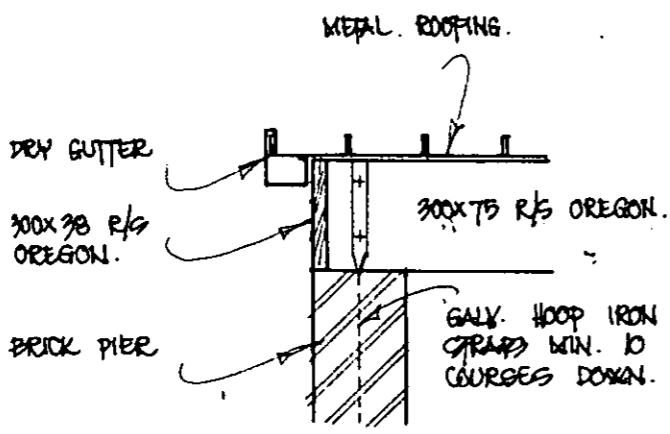

detail a-a 1:20

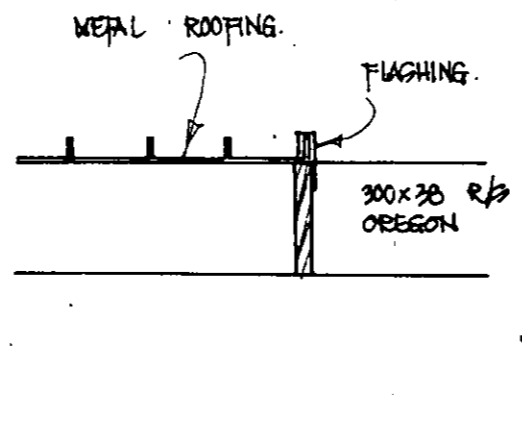

detail b-b 1:20

BUILDINGS (DESIGN AND CONSTRUCTION) ACT
 ORDINANCE 1936 AS AMENDED
 APPROVAL GRANTED
 11 JUL 1977
 DELEGATE *J. J. [Signature]*
 DEVELOPMENT CONTROL SECTION

PROPOSED CARPORT
AT 5/61 CHARNWOOD
FOR MR & MRS C. LING

BY A. R. MARR PTY. LTD. 470 522 A.H. 542 300.

SCALE: 100, 1:20
 DATE: DEC '76.

DRAWING No CP61/5.



CERTIFICATE OF OCCUPANCY OR USE

Pursuant to Part V of the Building Ordinance 1972, the building consisting of;

Timber Pergola

situated at

Block <u>5</u>	Section <u>61</u>	Division <u>Charnwood</u>
or situated at		

is considered to be substantially in accordance with the prescribed requirements for occupancy and use, subject to the endorsements listed below .

Approved plan Nos. <u>439451D</u>		
Type of construction * <u>5</u>	Class of occupancy * <u>X</u> (* as defined in the Building Manual A.C.T.)	
Permit No. <u>58498</u>	Name of permit holder <u>K.C. Ling</u> OWNER - BUILDER	

Endorsements

.....

.....

.....

.....

.....

.....

.....

.....

.....

.....

The issue of this Certificate does not affect the liability of a person to comply with the provisions of a law of the Territory (including the Building Ordinance) relating to the building work nor does it authorise the use of the land contrary to a provision, covenant or condition of lease .

31184

D. Wilson 14 / 11 / 83
Deputy Building Controller date

SEE OVERLEAF

43945/D

PLANS/FILE No.
Received Building Station
- 4 NOV 1982
Dept. of the Capital Territory

APPROVED FOR CONSTRUCTION BY THE HOLDER
OF A CLASS "C" LICENCE.

CLASS OF OCCUPANCY: RESIDENCE I
OUTBUILDINGS V
2 NOV 1982
DEPUTY BUILDING CONTROLLER

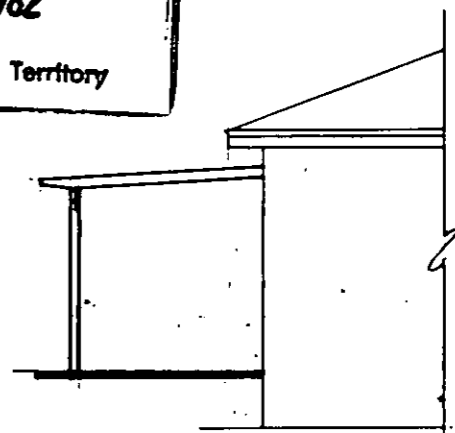
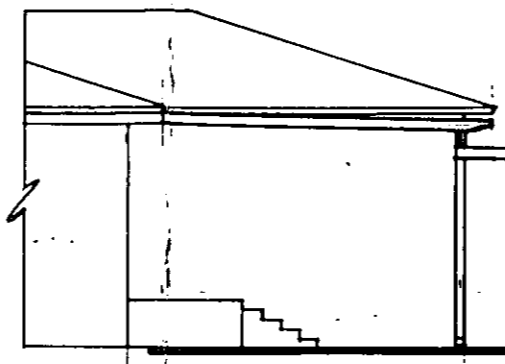
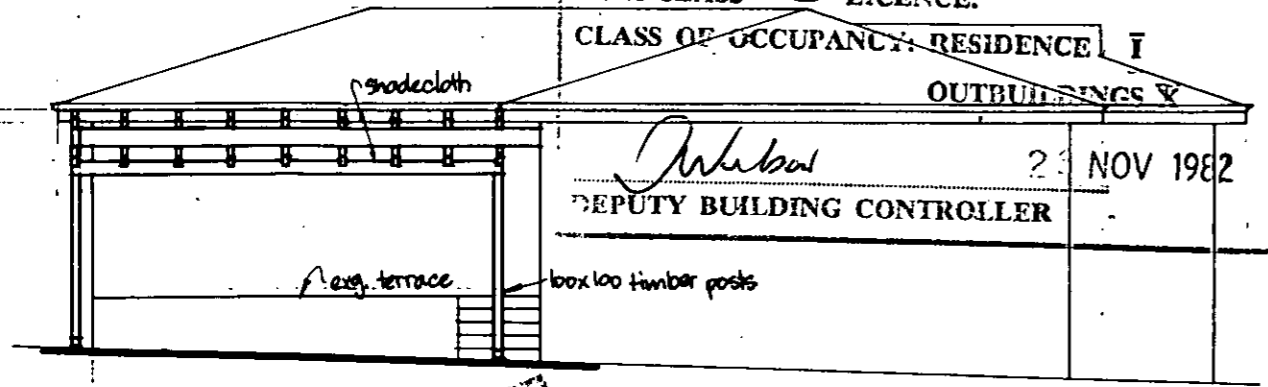

5/2

BUILDING WORK SHALL BE CONSTRUCTED IN ACCORDANCE WITH THE APPROVED BUILDING MANUAL ACT, THE NOTATIONS SPECIFIED ON THE PLANS AND ANY MATTERS SPECIFIED ON THE BUILDING PERMIT. THE APPROVAL OF PLANS OR THE GRANT OF A BUILDING PERMIT DOES NOT AFFECT THE OPERATION OF ANY OTHER LAW IN THE TERRITORY, NOR DOES IT AUTHORISE THE USE OF THE LAND CONTRARY TO A PROVISION, COVENANT OR CONDITION OF LEASE. MODIFICATIONS IF APPLICABLE

ELEVATION B

PLANS AND SPECIFICATIONS EXAMINED	1	/	19
RECOMMENDED FOR APPROVAL BY			
ENGINEER FOR WATER SUPPLY AND SEWERAGE			
CHIEF ELECTRICAL ENGINEER			
STRUCTURAL ENGINEER			

ELEVATION C

BUILDINGS (DESIGN AND SITING) ORDINANCE 1964 AS AMENDED
APPROVAL GRANTED
11 NOV 1982
DELEGATE
NATIONAL CAPITAL DEVELOPMENT COMMISSION

ELEVATION A 1:100

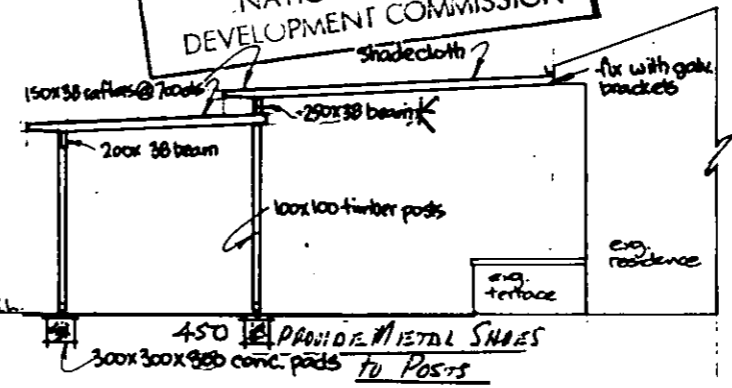

SECTION A'-A' 1:100

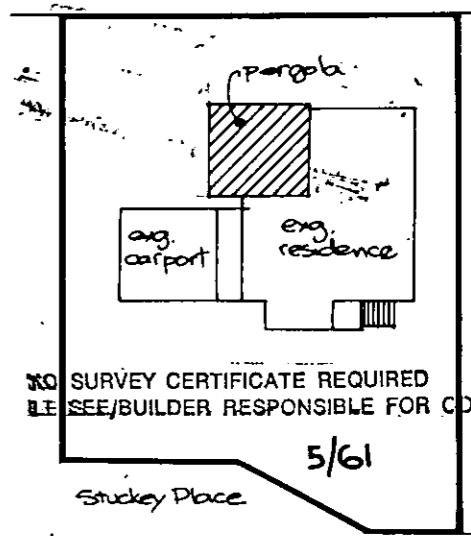

NO SURVEY CERTIFICATE REQUIRED
SEE/BUILDER RESPONSIBLE FOR CORRECT SITING
5/61
SITE PLAN 1:500

FOOTINGS TO BE TAKEN DOWN TO SOLID GROUND

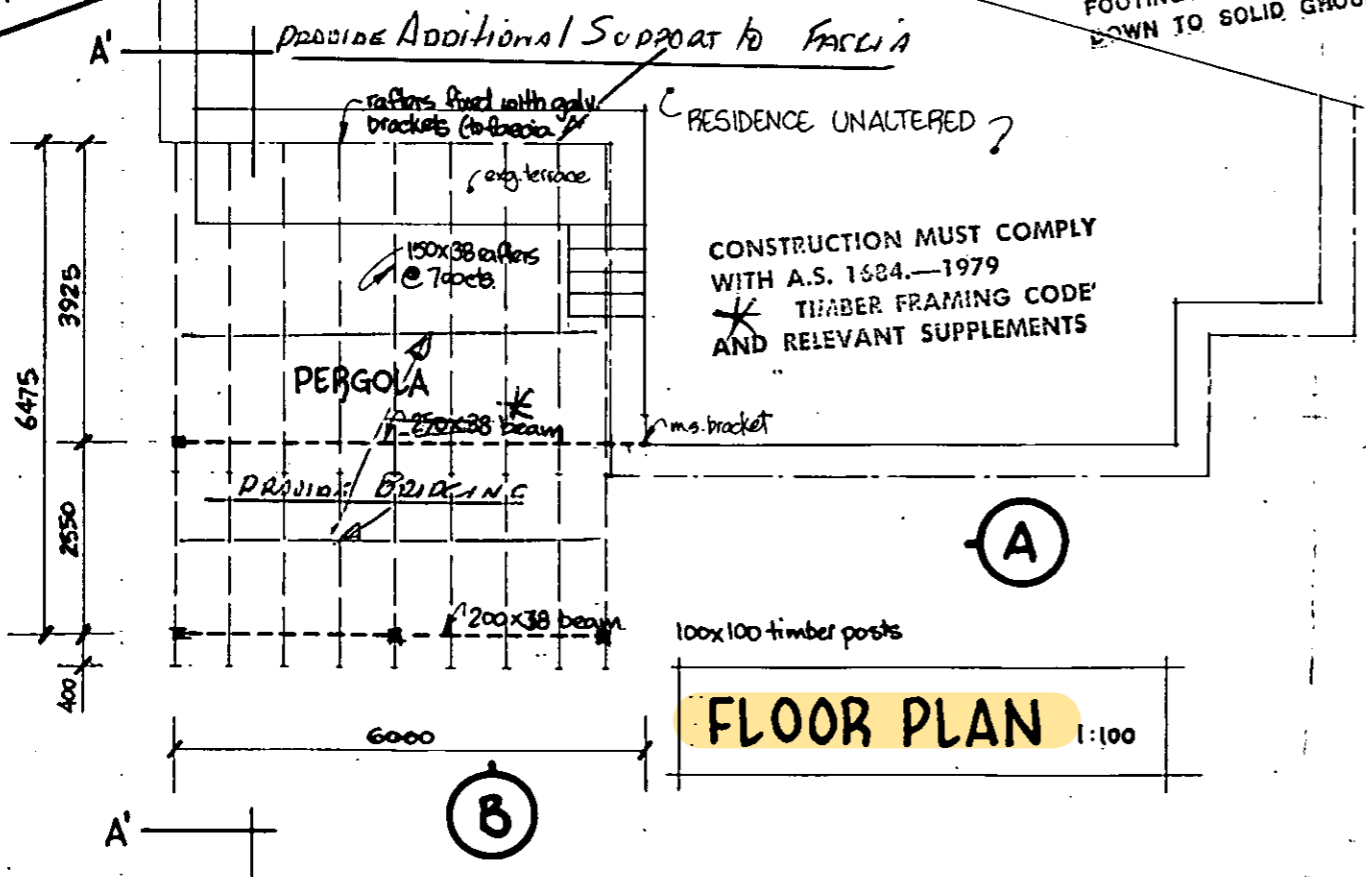

FLOOR PLAN 1:100

NOTES

1. Scale is 1:100 or as noted.
2. Dimensions are in millimetres or as noted.
3. All work in accordance with the ACT Building Manual and relevant S.A.A. Codes.
4. Terrain Category 3.

TIMBER PERGOLA TO EXISTING RESIDENCE FOR Mr & Mrs C. LING OF BLOCK 5 SECTION 61 CHARNWOOD

INCHES

PLAN OF SANITARY DRAINAGE

DRAINAGE PLAN No 29003/D

OWNER AR. MARR P/L

BLOCK 5 SECTION 61 CHARNWOOD A.C.T.

REFERENCE

D.T. Disconnector Trap.	S.P.D. Stoneware Pipe Drain.	I.C. Inspection Chamber.	F.T. Floor Trap.
E.V. Educt Vent.	C.I.P. Cast Iron Pipe.	M.H. Man Hole.	S.V.P. Soil Vent Pipe.
G.T. Gully Trap.	I.O. Inspection Opening.	V.P. Ventilating Pipe.	V.R. Vertical Riser.
J.U. Jump Up.	F.P. Fixed Point.	E.J. Expansion Joint.	

NOTE: All work to be executed in accordance with Canberra Sewerage & Water Supply Regulations

SCALE: METRIC 1:500



FIXTURES

1. WATER CLOSET
2. BATH
3. BASIN
4. SHOWER
5. SINK
6. TROUGHS

AMENDED DESIGN

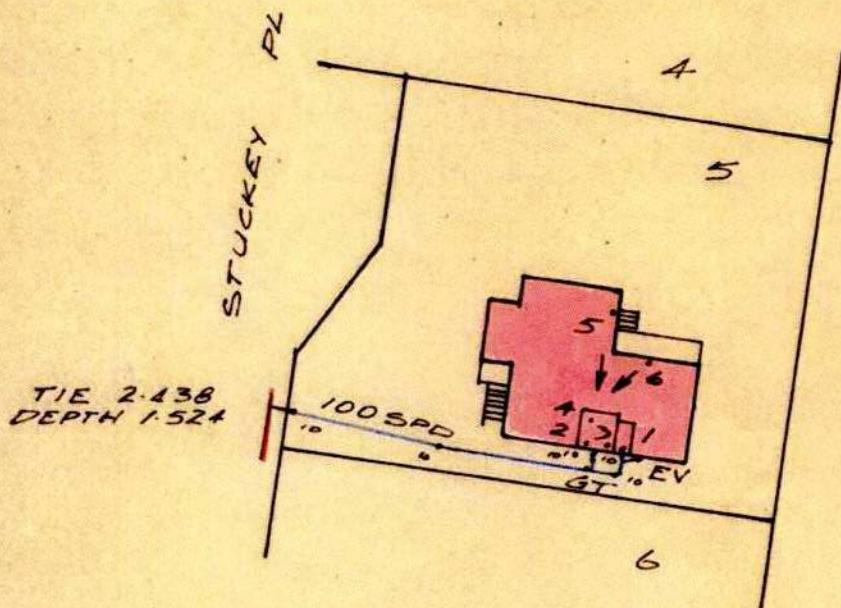

NOTES DRAINS TO BE LAID ARE SHOWN IN BLUE LINES. THIS PLAN TO BE READ IN CONJUNCTION WITH APPROVED ARCHITECTURAL PLANS AND SPECIFICATIONS.

DRAINS TO BE DELETED SHOWN BY RED X. EXISTING DRAINS SHOWN IN GREEN LINES. POSITION OF BRANCH TO BE LOCATED BEFORE ANY WORK IS COMMENCED.

~~DRAINS TO BE LAID IN (U.P.V.C.) UNPLASTICISED POLYVINYL CHLORIDE IN ACCORDANCE WITH 3.2.1 OF 37 1972 AND CANBERRA CODE OF PRACTICE ISSUE 1 JULY 1972~~

Designed by MOORE & SMITH PTY. LTD. Phone 95 9236
Plumbing & Drainage Consultants

DRAWN GMB-76

REF R471

M. O. Toad
SEWERAGE ENGINEER
30.8.76.

PAYMENT PENDING

As per terms and conditions in the Residential Reports Client Guarantee



Tax Invoice

Inspection Number 46947

Please ensure this number is used when making payment

11 May 2026

Jarrold Stirling & Michelle Scott

For the Property at: 9 Stuckey Place Charnwood ACT 2615

NO PAY UPFRONT RAPID INSPECTIONS PACKAGE	
Access Canberra conveyancing fees (no GST)	181.00
Property Inspection and Report (package price)	520.00
Timber Pest Inspection and Report (package price)	490.00
Building Compliance Inspection and Report (package price)	475.45
First Rate Energy Efficiency Inspection & Report (complimentary)	0.00
Subtotal	1,666.45
Total GST	148.55
TOTAL INC GST	\$1,815.00

Thank you for your business

We offer comprehensive Pest Management Solutions!
Call now to book your regular Pest Control Service

No Pay Package Conditions: This invoice must be paid on settlement or within 180 days of the date of inspection, whichever comes first. We must be notified immediately if the property is not marketed within 3 months or is withdrawn from the market and the invoice must be settled within 14 days. Failure to adhere to these terms will result in associated legal and collection fees being applied to amount due.

PAYMENT OPTIONS	
	To avoid unallocated payments please use reference number: 46947
Credit Card	Please call 6288 0402 to provide card details. Your account is not debited until the day reports are released. Providing these details as soon as possible will ensure there is no delay when reports are ready.
Direct Deposit	Account Name: Residential Reports BSB: 012-997 Account Number: 2269 05945 Reference: 46947 IMPORTANT: PLEASE ensure this unique ID is used



A PERCENTAGE OF EVERY JOB IS DONATED TO OUR WITHOUT A ROOF PROGRAM

Every year we step into hundreds of homes, yet in our region there are still so many people living without acceptable, permanent or safe shelter. A percentage from each inspection we conduct is contributed to our in-house program 'Without a Roof' and periodically donated to make small changes to this big issue. To find out more visit residentialreports.com.au

Residential Reports Pty Limited **ABN 38 609 880 122**

35 Poynton Street Hughes ACT 2605 **p 6288 0402** info@residentialreports.com.au

Member- Master Builders Association & The Australian Environmental Pest Managers Association