

Report

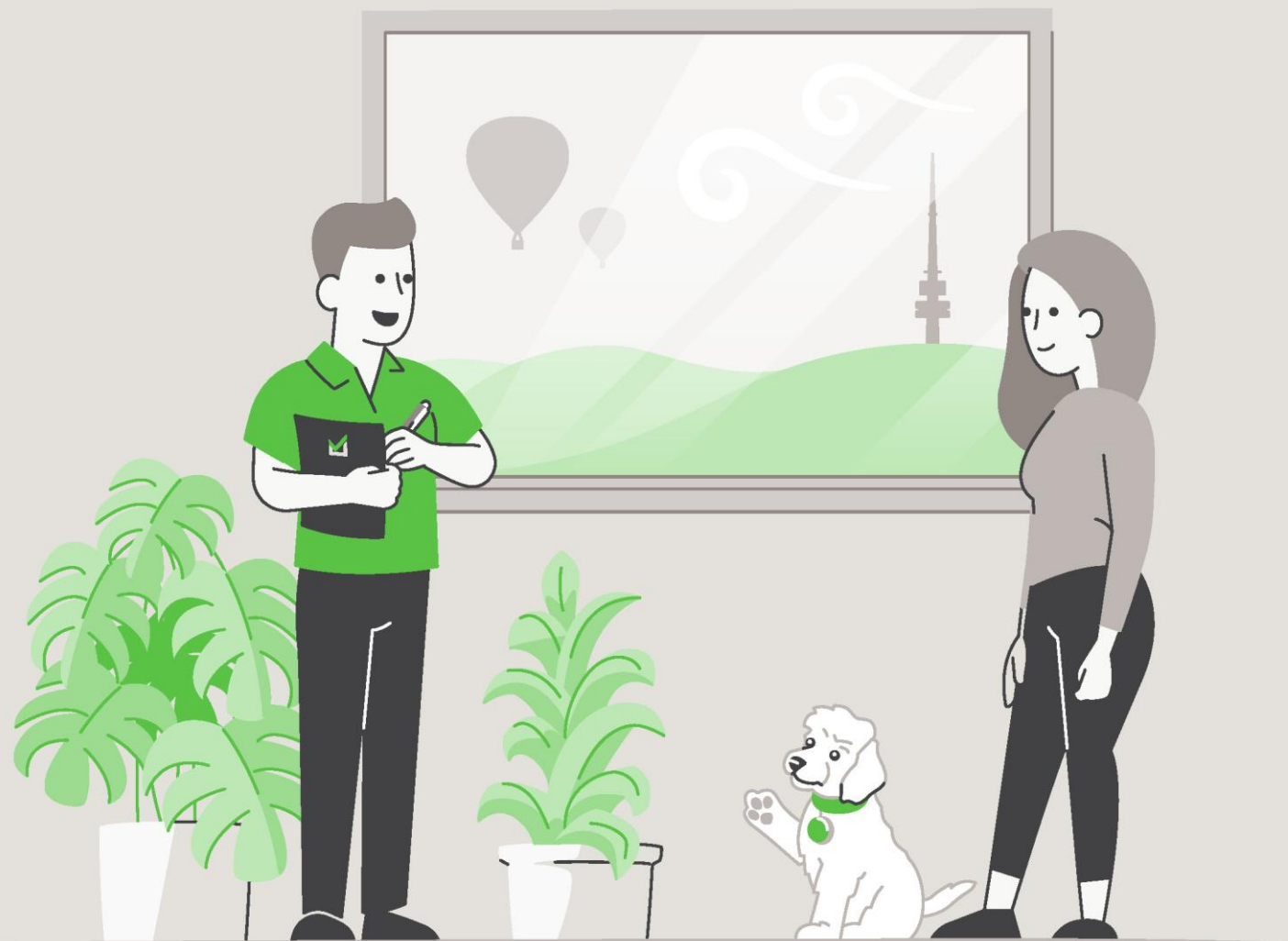

LIMITED LIABILITY TO A PURCHASER WITHIN THE AUSTRALIAN CAPITAL TERRITORY

This Report is made solely for the use and benefit of the Client. The Consultant is not liable for any reliance placed on this report by any third party. However, within the ACT only and in accordance with the Civil Law (Sale of Residential Property) Act 2003 and the Civil Law (Sale of Residential Property) Regulations 2004, a copy of the report must be attached to the Contract for Sale and may in certain circumstances be relied upon by the Purchaser of residential property.

The circumstances in which a Purchaser of residential property within the ACT may rely on this report in respect of the state of the property at the time of the inspection are as follows:

- (a)** The inspection was carried out no earlier than three months before the day the property was first advertised or offered for sale or listed by an agent; and
- (b)** The date on which the contract was entered into was not more than 180 days after the date of the inspection.
- (c)** The report is provided to the Purchaser prior to or at the time the Contract for Sale is entered into between the Purchaser and vendor.
- (d)** The service requested is the Standard Inspection Report.

Building Report

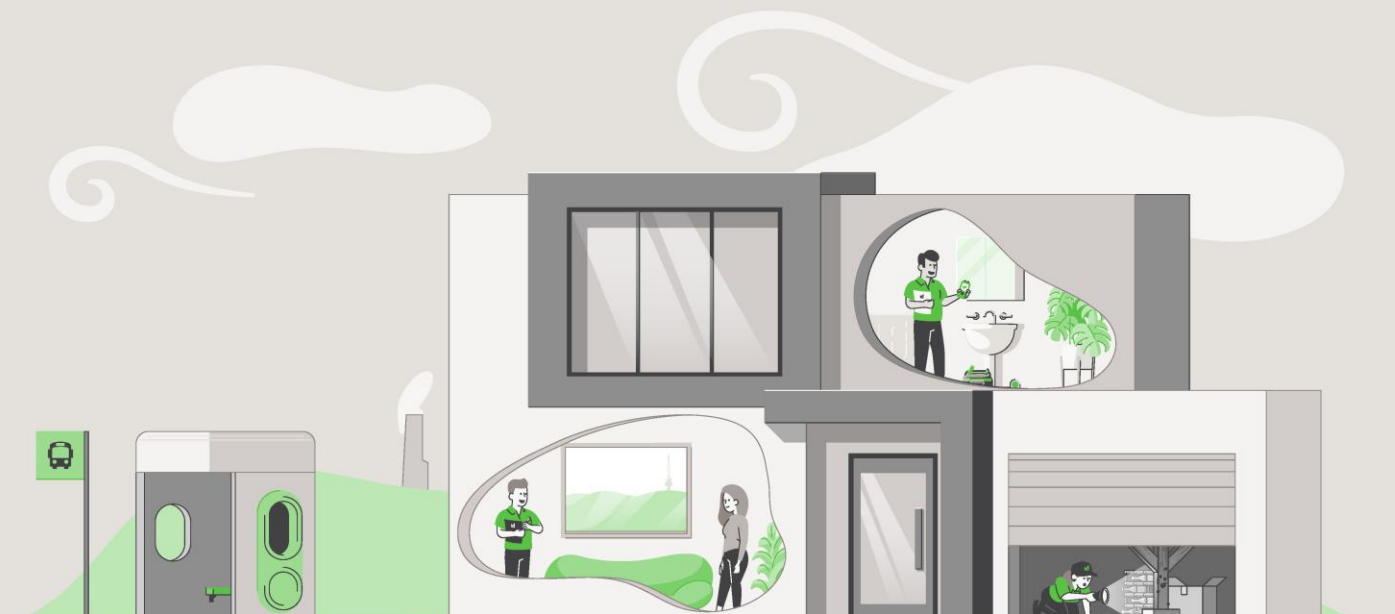

CONCLUSION AND SUMMARY

The purpose of the Inspection is to identify the major defects and safety hazards associated with the property at the time of the Inspection. The Inspection and reporting are limited to a visual assessment of the Building Members in accord with Appendix C AS4349.1-2007.

The overall condition of this building has been compared to similar constructed buildings of approximately the same age where those buildings have had a maintenance program implemented to ensure that the building members are still fit for purpose.

The incidence of Major Defects in this Residential Building as compared with similar Buildings is considered: **Low**

The incidence of Minor Defects in this Residential Building as compared with similar Buildings is considered: **Medium**

The overall condition of this Residential Dwelling in the context of its age, type and general expectations of similar properties is: **Above Average**

Please Note: This is a general appraisal only and cannot be relied upon on its own – read the Report in its entirety.

This Summary is supplied to allow a quick and superficial overview of the Inspection results. This Summary is NOT the Report and cannot be relied upon on its own. This Summary must be read in conjunction with the full Report and not in isolation from the Report. If there should happen to be any discrepancy between anything in the Report and anything in this Summary, the information in the Report shall override that in this Summary.

PROPERTY STATISTICS

Building Report	Above Average
Compliance Report	No unapproved structures
Pest Inspection	No active subterranean termites (live specimen) were found
Energy Efficiency Rating	4.0 Stars
Inspection Date	Wednesday, April 8 th 2026
Name of Assessor	Ben Halse
Reference Number	69115
Address of Property Inspected	89 Barr Smith Avenue, Bonython ACT 2905
Client	Vujik & Vujic
Block and Section	Block 2 Section 23 BONYTHON
Year original residence COU was issued	1991
Block size (approximately)	860m ²
House size (approximately)	Residence: 122.41m ² Carport: 40.50m ²
Weather conditions at time of Inspection	Fine
Occupancy Status	Unoccupied

*The table above is to be used as a quick reference. Please read the full Report before reaching your conclusion regarding the condition of the Property.

Whilst every care has been taken to ensure the accuracy of the property house and block size, we accept no responsibility for any inaccuracies as supplying this information exceeds a standard building inspection under AS4349.1-2007.

PROPERTY CONSTRUCTION DETAILS

Flooring	Concrete slab
External walls	Brick veneer
Roof framing	Timber: Truss roof framing
Roof cladding	Concrete roof tiles
Glazing	Single glazed windows
Cooktop	Electric cooktop
Oven	Electric oven
Dishwasher	A dishwasher has not been installed. There are provisions allowed in the joinery to allow a dishwasher to be inserted

*Whilst every care has been taken to ensure the accuracy of the property construction details, we accept no responsibility for any inaccuracies of construction details or testing of appliances.

GENERAL ACCESS LIMITATIONS

Internal	The house was unfurnished at the time of inspection, allowing a full visual inspection to be carried out
External	A full inspection was carried out to the exterior of the building
Roof void	NOTE. Inspection around the eaves was restricted due to low pitch and clearance to allow bodily access in this area. This allows only for a limited visual inspection from a distance to be carried out. Other restrictions found in the roof void: Insulation on top of ceiling restricting visual inspection of the ceiling framing. Ducting flex throughout the roof space restricting access in areas. Areas of the roof void were restricted by low crawl space
On-top of roof	The inspection was restricted to visually looking from a 3.6m ladder lent against the gutter in several areas around the building

*Where access is noted as limited or restricted, it is recommended that access be gained to these areas as these areas may contain concealed defects.

DEFINITIONS

Good	The item is in the Inspector's opinion of an acceptable standard with no defects visible. Superficial defects will not be commented on
Fair	The item in the Inspector's opinion has some minor defects and requires minimal maintenance or repair
Poor	The item in the Inspector's opinion needs significant repair or replacement

ENTRANCE

Ceiling	Good
Walls	Good
Door and door hardware	Good
Floor coverings	Good
Coat cupboard	Good

LOUNGE ROOM

Ceiling	Good
Walls	Good
Floor coverings	Good

DINING ROOM

Ceiling	Good
Walls	Good
Floor coverings	Good

FAMILY ROOM

Ceiling	Good
Walls	Good
Door and door hardware	Good
Floor coverings	Good

KITCHEN

Ceiling	Good
Walls	Good
Door and door hardware	Good
Floor coverings	Good
Kitchen cupboards	Good
Bench top	Good
Splashback	Good
Exhaust fan	The exhaust fan was operational at the time of inspection
Linen cupboard	Good

BEDROOM 1

Ceiling	Good
Walls	Swelling was noted to various areas of the skirting and to the base of the wardrobe architrave. A moisture meter was used at the time of inspection and indicated normal levels. Apart from monitoring no action is required
Door and door hardware	Good
Floor coverings	Good
Wardrobe	Good

BEDROOM 2

Ceiling	Good
Walls	Good
Door and door hardware	Good
Floor coverings	Good
Wardrobe	Good

BEDROOM 3

Ceiling	Good
Walls	Swelling was noted to the skirting. A moisture meter was used at the time of inspection and indicated normal levels. Apart from monitoring no action is required
Door and door hardware	Good
Floor coverings	Good
Wardrobe	Good

BATHROOM

Ceiling	Good
Walls	Good
Door and door hardware	Swelling was noted to the lower door jamb/architraves adjacent the shower into bedroom 1. A moisture meter was used at the time of inspection, indicating no moisture present. Recommend monitoring after regular and prolonged use. The striker plate on the door jamb to bedroom 1 needs adjustment to allow the door to latch
Floor coverings	Several fractured floor tiles were noted. The floor is still considered to be in serviceable condition and repairs are optional
Shower screen	Good
Water leakage in shower area?	There are indications that the shower has leaked with swelling to the adjacent door jamb. The shower was run for several minutes, and a leak was not evident. Recommend monitoring after regular and prolonged use and undertaking repairs by a qualified tradesperson as required
Floor and wall tiles in shower area	A minor cracked tile was noted to the shower hob base. It is advised to seal over the cracked tile and monitor. There were some areas in the tiles where the grout has come away. This is a common defect and can be fixed by re-grouting the affected areas
Taps	Minor leakage was noted from the shower arm when operated. Recommend repairs
Bath	Good
Exhaust fan	The exhaust fan was operational at the time of inspection

POWDER ROOM/TOILET

Ceiling	Good
Walls	Good
Door and door hardware	Good
Floor coverings	Good
Vanity/Basin	Good
Taps	Good
Toilet suite	Good
Exhaust fan	An exhaust fan is not installed; however, ventilation is provided to the room by opening the window

LAUNDRY

Ceiling	Good
Walls	Good
Door and door hardware	Good
Floor coverings	Good
Laundry tub	Good
Splashback	Good
Exhaust fan	An exhaust fan is not installed; however, ventilation is provided to the room by opening the window

ROOF CAVITY

Construction	Good
Heating flexible ducts	The plastic surrounds on several flexible ducts are deteriorating. Recommend repairs by an air conditioning specialist

EXTERIOR

Driveway and paths	Several areas of cracking and movement noted in the exterior concrete. The cracking and movement found is typical for a home of this age
Roof covering	Several minor cracked and chipped tiles noted which is common on tiled roofs of this age. Consideration should be given to replacement of affected tiles. Some silicone repairs have been made
Roof pointing	The roof pointing is generally good; however, there are some areas of minor cracking/flaking
Roof flashings	Good
Eaves	A small area of the eave sheets has slightly dropped, to the front left-hand corner. Recommend nailing the eave sheet back into position. Areas of flaking paint were noted to the quad
Fascia	Areas of general weathering and flaking paint noted on the timber fascia. Recommend re-painting the fascia to slow the weathering process
Gutters	The gutters are in typical condition for a home of this age with signs of corrosion evident. Replacement of the gutters will be needed in the future. The gutters along the front are holding water in areas. Recommend adjusting the gutter brackets to promote the rainwater runoff to drain towards the downpipes. The gutters also are blocked by debris in areas. Recommend clearing. The external corners to gutter along the rear wall have separated. Recommend repairs by a roofer
External walls	Good. No major cracking noted
Windows/doors	The rubber sill flashing at the bottom of several external windows has been pushed into the wall cavity. Recommend repairs. A chipped tile was noted along the exterior sliding door threshold. Repairs are considered optional
Fences	Good
Gates	Good
Pergola	The timber pergola is in serviceable condition; however, timber decay was noted to the external corner beams and post. Recommend repairs
Carport	The overall condition of the carport is fair/serviceable and considered typical for a structure of this age. Minor corrosion was noted to the base of the posts. Recommend removing the corrosion and re-painting with a rust/corrosion inhibitor. The gutters also require clearing out
Retaining walls	Some minor cracking was found in the retaining walls. The walls are still retaining the ground adequately. Apart from monitoring, no action is required
Site drainage	The site generally drains away from the perimeter of the building

DEFINITIONS

Above Average: The overall condition is above that consistent with dwellings of approximately the same age and construction. Most items and areas are well maintained and show a reasonable standard of workmanship when compared with buildings of similar age and construction.

Average: The overall condition is consistent with dwellings of approximately the same age and construction. There will be areas or items requiring some repair or maintenance.

Below Average: The Building and its parts show some significant defects and/or very poor non-tradesman like workmanship and/or long-term neglect and/or defects requiring major repairs or reconstruction of major building elements.

Client: The person or persons, for whom the Inspection Report was carried out or their Principal (i.e., the person or persons for whom the report is being obtained).

Building Consultant: A person, business or company who is qualified and experienced to undertake a pre-purchase inspection in accordance with Australian Standard AS 4349.1-2007 'Inspection of Buildings. Part 1: Pre-Purchase Inspections – Residential Buildings'. The consultant must also meet any Government licensing requirement, where applicable.

Building & Site: The inspection of the nominated residence together with relevant features including any car accommodation, detached laundry, ablution facilities and garden sheds, retaining walls more than 700 mm high, paths and driveways, steps, fencing, earth, embankments, surface water drainage and storm water run-off within 30 m of the building, but within the property boundaries. In the case of strata and company title properties, the inspection is limited to the interior and immediate exterior of the nominated residence and does not include inspection of common property.

Readily Accessible Areas: Areas which can be easily and safely inspected without injury to person or property, are up to 3.6 metres above ground or floor levels or accessible from a 3.6 metre ladder, in roof spaces where the minimum area of accessibility is not less than 600 mm high by 600 mm wide and subfloor spaces where the minimum area of accessibility is not less than 400 mm high by 600 mm wide, providing the spaces or areas permit entry. Or where these clearances are not available, areas within the consultant's unobstructed line of sight and within arm's length.

Structure: The loadbearing part of the building, comprising the Primary Elements.

Primary Elements: Those parts of the building providing the basic loadbearing capacity to the Structure, such as foundations, footings, floor framing, loadbearing walls, beams, or columns. The term 'Primary Elements' also includes other structural building elements including those that provide a level of personal protection such as handrails; floor-to-floor access such as stairways; and the structural flooring of the building such as floorboards.

Secondary Elements: Those parts of the building not providing loadbearing capacity to the Structure, or those non-essential elements which, in the main, perform a completion role around openings in Primary Elements and the building in general such as non-loadbearing walls, partitions, wall linings, ceilings, chimneys, flashings, windows, glazing or doors.

Finishing Elements: The fixtures, fittings and finishes applied or affixed to Primary Elements and Secondary Elements such as baths, water closets, vanity basins, kitchen cupboards, door furniture, window hardware, render, floor, and wall tiles, trim or paint. The term 'Finishing Elements' does not include furniture or soft floor coverings such as carpet and lino.

Major Defect: A defect of significant magnitude where rectification has to be carried out in order to avoid unsafe conditions, loss of utility or further deterioration of the property.

Minor Defect: A defect other than a Major Defect.

Safety Hazard: Any item that may constitute an immediate or imminent risk to life, health, or property. Occupational, health and safety or any other consequence of these hazards has not been assessed.

Tests: Where appropriate the carrying out of tests using the following procedures and instruments:

Dampness Tests means additional attention to the visual examination was given to those accessible areas which the consultant's experience has shown to be particularly susceptible to damp problems. Instrument testing using electronic moisture detecting meter of those areas and other visible accessible elements of construction showing evidence of dampness was performed.

Physical Tests means the following physical actions undertaken by the consultant: opening and shutting of doors, windows and draws; operation of taps; water testing of shower recesses; and the tapping of tiles and wall plaster.

IMPORTANT ADVICE

NB. In the case of strata and company title properties, the Inspection is limited to the interior and immediate exterior of the particular unit being inspected. The exterior above ground floor level is not inspected. The complete Inspection of other common property areas would be the subject of a Special-Purpose Inspection Report which is adequately specified.

Trees: Where trees are too close to the house this could affect the performance of the footing as the moisture levels change in the ground. A Geotechnical Inspection can determine the foundation material and provide advice on the best course of action with regards to the trees.

The Septic Tanks: Should be inspected by a licensed plumber.

Swimming Pools: Swimming Pools/Spas are not part of the Standard Building Report under AS4349.1-2007 and are not covered by this Report. We strongly recommend a pool expert should be consulted to examine the pool and the pool equipment and plumbing, as well as the requirements to meet the standard for pool fencing. Failure to conduct this Inspection and put into place the necessary recommendations could result in finds for non-compliance under the legislation.

Surface Water Drainage: The retention of water from surface run off could have an effect on the foundation material which in turn could affect the footings to the house. Best practice is to monitor the flow of surface water during rainfall and stormwater runoff and have the water directed away from the house or to storm water pipes by a licensed plumber/drainier.

Weep Holes: External brick (and stone) walls are a porous material that behave much like a sponge. During a rain event, the masonry wall absorbs water and actually stores it. The weep holes are designed for two purposes. 1. To provide an opening to allow water to drain out through the bottom of the wall. 2. To allow ventilating air to enter behind the wall to help dry the structure. If weep holes have been noted as being not installed, it is recommended to consult a builder on how to best rectify the problem.

Water Leaks from Roof: The inspector cannot, and does not, offer an opinion on whether the roof currently leaks or may be subject to future leaks. The only way to determine whether a roof is absolutely watertight is to make observations during prolonged rainfall.

Subfloor dampness: The presence of dampness is not always consistent as the prevailing and recent weather conditions at the time an inspection is carried out may affect the detection of damp problems. The absence of any dampness at the time of inspection does not necessarily mean the building will not experience some damp problems in other weather conditions. Likewise, whether or not services have been used for some time prior to an inspection being carried out will affect the detection of dampness.

Shower: Where a shower recess has been water tested, and no leakage was evident, this does not necessarily mean that the shower will not leak after prolonged use. Accordingly, to fully detect and assess a damp problem may require the monitoring of the building over a period of time.

SCOPE AND LIMITATIONS

Any person who relies upon the contents of this Report does so acknowledging that the following clauses, which define the Scope and Limitations of the Inspection, form an integral part of the Report.

1) This Report is not an all-encompassing Report dealing with the building from every aspect. It is a reasonable attempt to identify any obvious or significant defects apparent at the time of the Inspection. Whether or not a defect is considered significant or not, depends to a large extent upon the age and type of the building inspected. This Report is not a Certificate of Compliance with the requirements of any Act, Regulation, Ordinance or By-law. It is not a structural Report. Should you require any advice of a structural nature you should contact a structural engineer.

2) This is a visual Inspection only, limited to those areas and sections of the property fully accessible and visible to the Inspector on the date of Inspection. The Inspection DID NOT include breaking apart, dismantling, removing, or moving objects including, but not limited to, foliage, mouldings, roof insulation/sisalation, floor or wall coverings, sidings, ceilings, floors, furnishings, appliances, or personal possessions. The inspector CANNOT see inside walls, between floors, inside skillion roofing, behind stored goods in cupboards and other areas that are concealed or obstructed. The inspector DID NOT dig, gouge, force or perform any other invasive procedures. Visible timbers CANNOT be destructively probed or hit without the written permission of the property owner.

3) This Report does not and cannot make comment upon: Defects that may have been concealed; the assessment or detection of defects (including rising damp and leaks) which may be subject to the prevailing weather conditions; whether or not services have been used for some time prior to the Inspection and whether this will affect the detection of leaks or other defects (e.g. In the case of shower enclosures the absence of any dampness at the time of the inspection does not necessarily mean that the enclosure will not leak); the presence or absence of timber pests; gas-fittings; common property areas; environmental concerns; the proximity of the property to flight paths, railways, or busy traffic; noise levels; health and safety issues; heritage concerns; security concerns; fire protection; site drainage (apart from **surface** water drainage); swimming pools and spas (non-structural); detection and identification of illegal building work; detection and identification of illegal plumbing work; durability of exposed finishes; neighbourhood problems; document analysis; electrical installation; any matters that are solely regulated by statute; any area(s) or item(s) that could not be inspected by the consultant.

Accordingly, this Report is NOT a guarantee that defects and/or damage does not exist in any inaccessible or partly inaccessible areas or sections of the property.

NB. Such matters may, upon request, be covered under the terms of a 'Special-Purpose Property Report'.

4) Consumer Complaints Procedure: In the event of any dispute or claim arising out of, or relating to the Inspection or the Report, you must notify us as soon as possible of the dispute or claim by email, fax, or mail. You must allow us (which includes persons nominated by us) to visit the property (which visit must occur within twenty eight (28) days of your notification to us) and give us full access in order that we may fully investigate the complaint. You will be provided with a written response to your dispute or claim within twenty-eight (28) days of the date of the Inspection.

If you are not satisfied with our response, you must within twenty one (21) days of your receipt of our written response, refer the matter to a Mediator nominated by us from the Institute of Arbitrators and Mediators of Australia. The cost of the Mediator will be borne equally by both parties, and as agreed as part of the mediated settlement.

Should the dispute or claim not be resolved by mediation, then the dispute or claim will proceed to arbitration. The Institute of Arbitrators and Mediators of Australia will appoint an Arbitrator who will hear and resolve the dispute. The arbitration, subject to any directions of Arbitrator, will proceed in the following manner:

(a) The parties must submit all written submissions and evidence to the Arbitrator within twenty one (21) days of the appointment of the Arbitrator; and

(b) The arbitration will be held within twenty one (21) days of the Arbitrator receiving the written submissions.

The Arbitrator will make a decision determining the dispute or claim within twenty one (21) of the final day of the arbitration. The Arbitrator may, as part of his determination, determine what costs, if any, each of the parties are to pay and the time by which the parties must be paid any settlement or costs.

The decision of the Arbitrator is final and binding on both parties. Should the Arbitrator order either party to pay any settlement amount or costs to the other party but not specify a time for payment, then such payment shall be made within twenty one (21) days of the order.

NB. In the event that you do not comply with the above Complaints Procedure and commence litigation against us, then you agree to fully indemnify us against any awards, costs, legal fees, and expenses incurred by us in having your litigation set aside or adjourned to permit the foregoing Complaints Procedure to complete.

5) Asbestos Disclaimer: “No Inspection for Asbestos was carried out at the property, and no Report on the presence or absence of Asbestos is provided”.

Buildings built prior to 1982 may have wall and/or ceiling sheeting, and other products including roof sheeting that contains Asbestos. Even buildings built after this date, up until the early 90s, may contain some Asbestos. Sheeting should be fully sealed. If you are concerned, the building was built prior to 1990, or if asbestos is noted as present within the property, then you should seek advice from a qualified asbestos removal expert as to the amount and importance of the asbestos present and the cost of sealing or removal. Drilling, cutting, or removing sheeting or products containing Asbestos is a high risk to peoples’ health. You should seek advice from a qualified asbestos removal expert.

6) Mould (Mildew and non-wood decay fungi) Disclaimer: Mildew and non-wood decay fungi are commonly known as mould. However, mould and their spores may cause health problems or allergic reactions, such as asthma and dermatitis in some people. No Inspection for mould was carried out at the property, and no Report on the presence or absence of mould is provided. If mould is noted as present within the property, or if you notice mould and you are concerned as to the possible health risk resulting from its presence, then you should seek advice from your local Council, State or Commonwealth Government Health Department, or a qualified expert such as an Industry Hygienist.

7) Magnesite Flooring Disclaimer: No Inspection for Magnesite Flooring was carried out at the property, and no Report on the presence or absence of Magnesite Flooring is provided. You should ask the owner whether Magnesite Flooring is present and/or seek advice from a Structural Engineer.

8) Estimating Disclaimer: Any estimates provided in this Report are merely opinions of possible costs that could be encountered, based on the knowledge and experience of the inspector, and are not estimates in the sense of being a calculation of the likely costs to be incurred. The estimates are NOT a guarantee or quotation for work to be carried out. The actual cost is ultimately dependent upon the materials used, standard of work carried out, and what a contractor is prepared to do the work for. It is recommended in ALL instances that multiple independent quotes are sourced prior to any work being carried out. The inspector accepts no liability for any estimates provided throughout this Report.

9) Note: If the Client has any doubt about the purpose, scope, and acceptance criteria on which the Report was based please discuss your concerns with the Consultant on receipt of the Report. The Client acknowledges that, unless stated otherwise, the Client as a matter of urgency should implement any recommendation or advice given in this Report.

IMPORTANT DISCLAIMER

Disclaimer Liability: No Liability shall be accepted on an account of failure of the Report to notify any problems in the area(s) or section(s) of the subject property physically inaccessible for Inspection, or to which access for Inspection is denied by or to the Inspector (including but not limited to or any area(s) or section(s) so specified by the Report).

Disclaimer of Liability to Third Parties: Compensation will only be payable for losses arising in contract or tort sustained by the Client named on the front of this Report. Any third party acting or relying on this Report, in whole or in part, does so entirely at their own risk. However, if ordered by a Real Estate Agent or a Vendor for the purpose of auctioning a property, then the Inspection Report may be ordered up to seven (7) days prior to the auction, copies may be given out prior to the auction and the Report will have a life of 14 days during which time it may be transferred to the purchaser. Providing the purchaser agrees to the terms of this agreement, then they may rely on the Report subject to the terms and conditions of this agreement and the Report itself.

NB. In the ACT under the Civil Law (Sale of Residential Property) Act 2003 and Regulations, the Report resulting from this Inspection may be passed to the purchaser as part of the sale process, providing it is carried out no more than three months prior to listing and is not more than six months old.

Limited Liability to a Purchaser within the Australian Capital Territory only: Within the Australian Capital Territory (ACT) and in accordance with the ACT Civil Law (Sale of Residential Property) Act 2003 and Regulations, a copy of the Report may be attached to the Contract for Sale.

WARNING: The Purchaser is advised that this Report reflects the condition of the property existing at the time of the Inspection (Inspection Date) and may not reflect the current state. It is, therefore, very strongly recommended that you promptly arrange for another Inspection and Report in accordance with Australian Standard AS4349.1 to be carried out prior to the expiration of the 'Cooling off Period' and settlement.

This is not a Compliance Report strictly in accordance with Civil Law (Sale of Residential Property) Regulations: The Report may contain copies of any approved plans, building approvals, building permit and Certificates of Occupancy. However, any comments made by the person who prepared the Report as to whether or not, in the opinion of the Inspector, the structures on the land substantially comply with the approved plans (if any) are made on the basis of a cursory glance of the plans and not upon a detailed examination. Any opinion expressed as to whether or not any building approval or approval under the Land (Planning and Environment) Act, 1991, is based on the limited knowledge and belief, at the time, of the Inspector. The Purchaser is advised that a Special Purpose Report is available through the Inspector to advise more fully in respect to these matters. The structures may have been damaged by pests, storm, strong wind or fire or the Vendor may have carried out alterations and/or additions to the Property since the Inspection Date. The Report may no longer reflect the true condition of the Property. The structure(s) may no longer be in accordance with the attached plans etc. IT IS STRONGLY RECOMMENDED that, if the Purchaser has any concerns in respect to the compliance of the structures, a Special Purpose Report be obtained. Alternatively, the Purchaser should rely upon his, her or their own enquiries.

Contact the Inspector: Please feel free to contact the Inspector who carried out this Inspection. Often it is very difficult to fully explain situations, problems, access difficulties, building faults or their importance in a manner that is readily understandable by the reader. Should you have any difficulty in understanding anything contained within this Report, then you should immediately contact the Inspector and have the matter explained to you. If you have any questions at all, or require any clarification, then contact the Inspector prior to acting on this Report.

OTHER INSPECTIONS AND REPORTS REQUIRED

It is strongly recommended that the following Inspections and Reports be obtained prior to any decision to purchase the Property. Obtaining these Reports will better equip the purchaser to make an informed decision. Although appliances may be listed in the Report, they have not been tested as this is outside the scope of the standard Building Inspection. Other Inspections we recommend the purchaser obtains before making their decision are:

- Electrical Inspection,
- Plumbing Inspection,
- Structural (Engineer),
- Geotechnical Inspection,
- Drainage Inspection,
- Asbestos Inspection,
- Mould Inspection,
- Gas fitting Inspection,
- Appliances Inspection,
- Air-conditioning Inspection,
- Alarm/Intercom/Data Systems,
- Hydraulics Inspection,
- Mechanical Services,
- Hazards Inspection,
- Fire/Chimney Inspection,
- Estimating Report,
- Garage Door Mechanical,
- Durability exposed surfaces

SMOKE DETECTORS

The occupier/purchaser should satisfy themselves as to the working condition of the smoke detectors, if installed. It is highly recommended that suitable smoke detectors be installed in all residential properties. AS 3786 advises that smoke detectors are required for all buildings where people sleep. It is recommended that an electrician be consulted to advise on those installed or install these detectors.

CRACKING OF BUILDING ITEMS

Regardless of the type of crack(s), a Pre-Purchase Building Inspector carrying out a Pre-Purchase Inspection within the scope of a visual Inspection is unable to determine the expected consequences of the cracks.

Obtaining Information regarding the below all fall outside the scope of this Pre-Purchase Inspection:

- (a)** The nature of the foundation material on which the building is resting,
- (b)** The design of the footings,
- (c)** The site landscape,
- (d)** The history of the cracks and,
- (e)** Carrying out an invasive Inspection.

However, the information obtained from the five items above is valuable in determining the expected consequences of the cracking and any remedial work needed. Cracks that are small in width and length on the day of the Inspection may have the potential to develop over time into structural problems for the homeowner, resulting in major expensive rectification work being carried out. If cracks have been identified in the Report above, then a Structural Engineer is required to determine the significance of the cracking prior to a decision to purchase.

NOTICE TO THE PURCHASER (ACT ONLY)

(a) At the Exchange, and prior to the 'Cooling-off Period', you were given an Inspection Report on the property you intend on purchasing. This Report reflects the condition of the property existing at the time of the Inspection (Inspection Date) and may not reflect the current state. The structures may have been damaged by pests, storm, strong wind or fire or the vendor may have carried out alterations and/or additions to the property since the Inspection date. The Report may no longer reflect the true condition of the property. The structure(s) may no longer be in accordance with the attached plans etc. It is, therefore, very strongly recommended that you urgently arrange for another Inspection and Report in accordance with Australian Standard AS 4349.1 to be carried out prior to exchange, or prior to the expiration of any 'Cooling Off Period' and prior to settlement.

(b) If the Report indicated the presence of termite damage, or recommends any other Inspections or treatments, you should obtain copies of these Reports and any treatment proposals, certificates of treatment carried out, including details of all repairs including copies of quotations, invoices, and any other Reports. It is strongly recommended that you arrange for an Inspection and Report in accordance with AS 4349.3 to verify that the treatment has been successful and carried out in accordance with AS 3660.2, and a further building Inspection in accordance with AS 4349.1.

(c) If you fail to procure a further Inspection and Report as recommended in (a) and (b), or fail to obtain copies of other Reports, treatment proposals, certificates of treatment carried out, details of all repairs including copies of quotations, invoices and any other Reports as recommended in (b) above, then you agree that you have decided not to have a further Inspection and Report carried out, or to obtain copies of treatment proposals, certificates of treatment carried out, details of all repairs including copies of quotations, invoices and any other Reports and have relied upon your own enquires and the Report, knowing the possible consequences, and that the condition of the property, as stated in the Report, may have changed.

(d) You agree that the person carrying out the Inspection **and** the company, partnership or sole trader that employs that person will have no liability to you for any damage or loss you may suffer as a result of your entering the contract to purchase the property, or in connection with completing the purchase of the property as a result of your failure to heed the advice given in (a) and (b) and the warning contained in (c) above, and may use such failure in defense of any claim that you may later make against any of them.

NB. It is a condition of your right to rely upon the Report that you transmit by fax, post, or otherwise deliver the signed "Notice to the Purchaser" (ACT only) to the company, partnership or sole trader at the address detailed on the front of the Report not less than four (4) days prior to the date of settlement. If you fail to complete, sign, or deliver the Notice then it will be deemed that you did not rely upon the report in respect to your decision as to whether or not to purchase the property. This may seriously affect any rights to future compensation to which you may be entitled.

Please cross out the statement below that does not apply: - At the date of settlement, not more than 180 days will have elapsed since the Inspection date.

1. I/We have read and understood the 'Limited Liability to a Purchaser within the Australian Capital Territory only' clause of the Report, and this Notice to the Purchaser. I/We have not arranged for another inspection and report in respect of the property, and it is my/our intention to **rely upon the findings contained in the report**; or

2. I/We have **arranged for another Inspection of the Property and Report** to be carried out, which I/We will use in conjunction with this Report in deciding whether to proceed with the purchase of the property; or

3. I/We have read and understood the 'Limited Liability to a Purchaser within the Australian Capital Territory only' clause of the Report, and this Notice to the Purchaser. I/We have not arranged for another Inspection and Report in respect of the property and have **relied on my/our own enquiries in respect of the condition of the property** as at the date of settlement including any changes in the condition of the property that have taken place since the Inspection date stated in the Report

Timber Pest Report



SUMMARY SHEET

Property Address: 89 Barr Smith Avenue, Bonython ACT 2905
Client: Vujik & Vujic
Inspection Date: Wednesday, April 8th 2026
Inspection carried out by: Ben Halse

This summary is supplied to allow a quick and superficial overview of the Inspection results. This summary is NOT the Report and cannot be relied upon on its own. This summary must be read in conjunction with the full Report and not in isolation from the Report. If there should happen to be any discrepancy between anything in the Report, and anything in this summary, the information in the Report shall override that in the summary. The Report is subject to conditions and limitations. Your attention is particularly drawn to the clauses, disclaimer of liability to third parties, limited liability to a purchaser with the Australian Capital Territory (ACT), and to the notice to the purchaser at the back of this Report.

1.0 ACCESS LIMITATIONS

There were access limitations to the inspection/report. Please refer to section 1.0 of the report.

2.0 TERMITE ACTIVITY

No active subterranean termites (live specimens) were found.

No visible evidence of subterranean termite workings or damage was found.

3.0 BORER ACTIVITY

No visible evidence of borers of seasoned timbers was found.

4.0 DECAY FUNGI

Evidence of timber wood decay was found. Please refer to Section 4.0 of the Pest Report.

For complete and accurate information, please refer to the attached 'Visual Timber Pest Report', which is prepared in accordance with AS 4349.3.

CONDITIONS OF THIS INSPECTION

Important Information:

Any person who relies upon the contents of this Report does so acknowledging that the following clauses, which define the scope and limitations of the Inspection, form an integral part of the Report.

This is a **Visual Inspection Only**, prepared in accordance with AS 4349.3, 'Inspection of Buildings Part 3: Timber Pest Inspections'. Visual Inspection was limited to those areas and sections of the property to which reasonable access (see definition) was both available and permitted on the date of Inspection.

The Inspection **did not** include breaking apart, dismantling, removing, or moving objects including but not limited to – foliage, mouldings, roof insulation/sisalation, floor or wall coverings, sidings, ceilings, floors, furnishings, appliances, or personal possessions.

The Inspector **cannot** see inside walls, between floors, inside skillion roofing, inside the eaves, behind stored goods in cupboards, or in any other areas that are concealed or obstructed.

The Inspector **did not** dig, gouge, force or perform any other invasive procedures. An invasive Inspection will not be performed unless a separate contract is entered into.

In an occupied property, it must be understood that furnishings or household items may be concealing evidence of Timber Pests, which may only be revealed when the items are moved or removed.

In the case of strata type properties, only the interior of the unit is inspected.

Scope of Report:

This Report only deals with the detection or non-detection of Timber Pest Attack and Conditions Conducive to Timber Pest Attack discernible at the time of inspection. The inspection was limited to the Readily Accessible Areas of the Building and Site (see note below) and was based on a visual examination of surface work (excluding furniture and stored items), and the carrying out of Tests. Note. With strata and company title properties, the inspection was limited to the interior and the immediate exterior of the particular residence inspected. Common property was not inspected.

Limitations:

The Client acknowledges:

- (a) This Report does not include the inspection and assessment of matters outside the scope of the requested inspection and report.
- (b) The inspection only covered the Readily Accessible Areas of the Building and Site. The inspection did not include areas which were inaccessible, not readily accessible or obstructed at the time of inspection. Obstructions are defined as any condition or physical limitation which inhibits or prevents inspection and may include – but are not limited to – roofing, fixed ceilings, wall linings, floor coverings, fixtures, fittings, furniture, clothes, stored articles/materials, thermal insulation, sarking, pipe/duct work, builder's debris, vegetation, pavements, or earth.
- (c) The detection of dry wood termites may be extremely difficult due to the small size of the colonies. No warranty of absence of these termites is given.
- (d) European House Borer (*Hylotrupes bajulus*) attack is difficult to detect in the early stages of infestation as the galleries of boring larvae rarely break through the affected timber surface. No warranty of absence of these borers is given. Regular inspections including the carrying out of appropriate tests are required to help monitor susceptible timbers.
- (e) This is not a structural damage report. Neither is this a warranty as to the absence of Timber Pest Attack.
- (f) If the inspection was limited to any particular type(s) of timber pest (e.g., subterranean termites), then this would be the subject of a Special-Purpose Inspection Report, which is adequately specified.
- (g) This Report does not cover or deal with environmental risk assessment or biological risks not associated with Timber Pests (e.g., toxic Mould) or occupational, health or safety issues. Such advice may be the subject of a Special-Purpose Inspection Report which is adequately specified and must be undertaken by an appropriately qualified inspector. The choice of such inspector is a matter for the Client.
- (h) This Report has been produced for the use of the Client. The Consultant or their firm or company are not liable for any reliance placed on this report by any third party, except as provided in the section Limited Liability To a Purchaser within the Australian Capital Territory.

Determining extent of Damage:

This is not a structural building report, and any inexpert opinion we provide on timber damage cannot be relied upon. This Report **will not** state the full extent of any Timber Pest damage. It will state Timber Pest Damage found as either 'slight', 'moderate', 'moderate to extensive', or 'extensive', and this information is not the opinion of an expert. If any evidence of Timber Pest activity and/or damage resulting from Timber Pest activity is reported, either in the structure(s) or the grounds of the property, then you must assume that there may be concealed structural damage within the building(s).

This concealed damage may only be found when wall linings, cladding or insulation are removed to reveal previously concealed timbers. In this case, an Invasive Timber Pest Inspection (for which a separate contract is required) is strongly recommended, and you should arrange for a qualified professional such as a builder, engineer, or architect to carry out a structural Inspection to determine the full extent of the damage, and the extent of repairs that may be required. You agree that neither we, nor the individual conducting the Inspection, are responsible or liable for the repair of any damage, whether disclosed by the Report or not.

Disclaimer of Liability:

No liability shall be accepted on account of failure of the Report to notify any termite activity and/or damage present at, or prior to, the date of the Report, in any area(s) or section(s) of the subject property physically inaccessible for Inspection, or to which access for Inspection is denied by, or to, the licensed Inspector (including, but not limited to, any area(s) or section(s) specified by the Report).

1.0 ACCESS LIMITATIONS

1.1 Area(s) inspected:

Only structures, fences &/or trees within 50m of the building but within the property boundaries were inspected.

1.2 Common area(s) not inspected:

No Inspection was made, and no Report will be submitted, of inaccessible area(s).

These include, but may not be limited to; cavity walls, concealed frame timbers, eaves, flat roofs, fully enclosed patios, inaccessible parts of the subfloors, inaccessible parts of the roof void, soil concealed by concrete floors, fireplace hearths, wall linings, landscaping, rubbish, floor coverings, furniture, pictures, appliances, stored items, insulation, and hollow blocks/posts etc.

1.3 Area(s) in which visual inspection was obstructed or restricted and why:

Ceiling framing timbers were concealed by insulation. Ducting flex throughout the roof space restricting access in areas. Areas of the roof void were restricted by low crawl space.

NB. Please note that since a complete Inspection of the above area(s) was not possible, Timber Pest activity and/or damage may exist in these areas.

1.4 The property was unfurnished at the time of inspection.

Where a property is furnished at the time of Inspection, it must be understood that the furnishings and stored goods may be concealing evidence of Timber Pest activity. This evidence may be revealed when the property is vacated, and a further Inspection of the vacant property is strongly recommended if the house was furnished at the time of inspection.

1.5 Undetected timber pest risk assessment is considered Moderate.

NB. Where the risk is considered "Moderate" or "Moderate-High" or "High", a further inspection is strongly recommended of areas that were not readily accessible, and of inaccessible or obstructed areas once access has been provided or the obstruction removed. This may require the moving, lifting or removal of obstructions such as floor coverings, furniture, stored items foliage and insulation. In some instances, it may also require the removal of ceiling and wall linings, and the cutting of traps and access holes. Seek further advice from your Consultant.

2.0 TERMITE ACTIVITY

2.1 No active (live) termites were present at the time of Inspection.

2.2 No visible evidence of subterranean termite workings and/or damage was found.

2.3 A termite nest was not found.

2.4 No evidence of timber damage caused by Termite attack was visible at the time of the Inspection.

NB. Where evidence of termite activity by the *Nasutitermes* or *Coptotermes* species was found in the grounds, the risk to buildings is very high. A treatment to eradicate the termites and to protect the building(s) should be carried out. Where the evidence of termite workings was found in the grounds or the building(s), then the risk of a further attack is very high.

2.5 Very important:

If live termites or any evidence of termite workings or damage was reported above, within the building(s) or in the grounds and fences, then it must be assumed that there may be concealed termite activity and/or timber damage. This concealed activity or damage may only be found when alterations are carried out, such as when wall linings, cladding or insulation are removed; or if you arrange for an invasive Inspection. We claim no expertise in structural engineering or building, and we strongly recommend that you have a qualified professional such as a builder, engineer, architect, or other qualified expert determine the full extent of the damage, if any. This may require an invasive Inspection. We take no responsibility for the repair of any damage, whether disclosed by this Report or not (see 'Terms and Limitations').

Where visual evidence of termite workings and/or damage is reported above, but no live termites were present at the time of Inspection, you must realise that it is possible that termites are still active in the immediate vicinity, and that the termites may continue to cause further damage. It is not possible, without further investigation and a number of Inspections over a period of time, to ascertain whether any infestation is active or inactive. Active termites may simply have not been present at the time of Inspection due to a prior disturbance or climatic conditions, or they may have been utilizing an alternative feeding source.

Continued, regular Inspections are essential. Unless written evidence of a termite protection program in accordance with 'AS 3660' with ongoing Inspections is provided, you must arrange for a treatment in accordance with 'AS 3660' to be carried out to reduce the risk of further attack.

2.6 Previous termite treatment: There were no signs of a termite treatment or evidence of a possible previous termite treatment, at the time of inspection.

NB. If there is evidence of drill holes in concrete or brickwork, bait stations or other signs of a possible previous treatment are reported, then the treatment was probably carried out because of an active termite attack. Extensive structural damage may exist in concealed areas. You should have an invasive Inspection carried out, and have a builder determine the full extent of any damage, and the estimated cost of repairs, as the damage may only be found when wall linings etc. are removed. Normally, if a termite treatment has been carried out, then a durable notice should be located in the metre box, indicating the type of termite shield system, treated zone or combination that has been installed.

2.7 Termite management: A durable notice (termite management notice) was not found during the inspection, indicating a barrier system has not been installed.

This firm can give no assurances with regard to work that may have been previously performed by other firms. You should obtain copies of all paperwork and make your own enquiries as to the quality of the treatment when it was carried out, and warranty information. In most cases, you should arrange for a treatment in accordance with "Australian Standard 3660" to be carried out to reduce the risk of further attack.

2.8 General remarks:

Where any current visible evidence of Timber Pest activity is found, it is strongly recommended that a more invasive Inspection be performed. Trees on and near the property up to a height of 2 metres, have been visually Inspected where possible and practicable, for evidence of Termite activity. It is very difficult to locate termite nests since they are underground, and evidence in trees is usually well concealed. Therefore, we strongly recommend that you arrange to have the medium to large eucalypt trees within a 50 metre radius of the property test drilled for evidence of termite nests.

3.0 BORER ACTIVITY

3.1 No visible evidence of borers was found.

The **Lyctid Borer** - The most common lyctid borer in Australia is **Lyctus brunneus (powder post beetle)**. Attack usually takes place during the first six to twelve months of the service life of timber. However, the powder post beetle is not considered a significant pest of timber and treatment of infestation is not usually required. As only the sapwood of certain hardwoods is destroyed, larger-dimensional timbers (such as rafters, bearers, and joists) in a building are seldom weakened significantly to cause collapse. The **Anobiid Borer** There are many different species of Anobiid borer, the most frequently encountered being *Anobium punctatum* (furniture beetle) and *Calymmaderus incisus* (Queensland pine beetle). Attack mainly occurs to softwoods especially pine timbers such as floorboards that have been in service for at least ten years. Should any structural timbers be attacked by Anobiid borers it is often difficult to determine what extent the borer damage has weakened such timbers and replacement is often the only way of ensuring safety from collapse.

In the case of Anobiid borers, once an attack is initiated it is unlikely to cease or die out of its own accord without some sort of eradication treatment. Therefore, unless proof of treatment is provided, evidence of an attack must always be considered active. Although a chemical treatment is an option, replacement of infested timbers with non-susceptible, or treated timber, is the most effective method of treatment. Before any option is considered, competent advice (e.g., from a licensed building contractor) should be sought to determine the extent of any structural damage, and as to the need or otherwise for rectification or repair work.

Other Borers: A further (more invasive) investigation is strongly recommended to determine whether infestation is still active and to positively identify the borer species responsible for the attack. Always seek further advice from the Consultant.

Management Program: Wherever practical, remove any conditions conducive to attack (e.g., *Anobium* borer thrive in badly ventilated subfloor areas). Regular inspections are recommended at intervals not exceeding 12 months. Always seek further advice from the Consultant.

4.0 DECAY FUNGI

4.1 Evidence of damage caused by wood decay (rot) fungi was found.

- **Timber decay was found in several exposed timbers (beams, posts) of the pergola.**

NB. If any evidence of fungal decay or damage is reported, you should consult a building expert to determine the full extent of damage, and the estimated cost of repairs or timber.

General Description of Attack Decaying wood contains sufficient moisture to retain its original shape and may have sufficient strength to withstand normal loads. In contrast decayed wood is reduced both in moisture content and size as indicated by cracking either along or across the grain or fibres coming apart in a stringy manner. Decayed wood will have undergone considerable strength reduction.

Economic Significance Fungal decay can cause at one extreme, structural failure of the affected timber, and at the other purely superficial surface damage. The most critical determination is that of which timber is affected and decaying because decay will most likely spread (unless sources of moisture are quickly removed). Affected and decayed timber may warrant timber replacement, but the rot should not spread unless a new moisture source becomes available in that area.

Where evidence of decayed timber exists, competent advice (e.g., from a licensed or registered building contractor) should be sought to determine the extent of any structural damage, and as to the need or otherwise for rectification or repair work. It is important to correct any condition conducive to attack prior to replacing decayed wood.

Where evidence of decaying timber exists, competent advice (e.g., from a licensed or registered building contractor) should be sought to remove the condition(s) conducive to attack, and to determine the extent of any structural damage, and as to the need or otherwise for rectification or repair work.

Where the full extent of damage or the overall condition of the timber is undetermined a further inspection is strongly recommended by a competent person (e.g., from a licensed or registered building contractor). This may require monitoring of the timber over a period and include the assessment of conditions conducive to attack in different weather conditions (e.g., to determine the adequacy of existing drainage).

Management Program Remove any conditions conducive to attack (e.g., lack of ventilation or the presence of excessive moisture). Regular inspections are recommended at intervals not exceeding 12 months. Always seek further advice from the Consultant.

5.0 CONDITIONS THAT ARE CONDUCTIVE TO TIMBER PESTS

5.1 Water leaks: At the time of the inspection no leaks were found to be present.

Water leaks, especially in or into the subfloor, or against the external walls; increase the likelihood of termite attack. Leaking showers or leaks from other 'wet areas' also increase the likelihood of concealed termite attack. Hot water overflows should be plumbed away from the building.

NB. We claim no expertise in building, and if any leaks were reported, you should consult a plumber or other building expert to determine the full extent of damage, and the estimated cost of repairs.

5.2 Moisture/drainage: Not applicable as the home is built on a concrete slab.

Lack of Adequate Subfloor Ventilation Inadequate ventilation provides a condition suitable for timber pest infestation. For example, subterranean termites thrive in damp humid conditions typical of those provided in a poorly ventilated subfloor space. Where evidence of a lack of adequate ventilation has been identified in the report, the Client should seek competent advice (e.g., from a licensed or registered building contractor) regarding upgrading ventilation. The Presence of Excessive Moisture Ground levels around the building should be maintained in such a way to minimise water entering under the building. Also, the ground surface in subfloor areas should be kept graded to ensure that moisture does not pond or accumulate in any area. Where necessary, sub-surface drains should be installed and maintained to assist with drainage around and under the building. Likewise, the presence of excessive moisture can often be directly related to ventilation limitations and the resultant high humidity. Also, plumbing oversights and defects such as a leaking drain or tap will provide a microclimate conducive to timber pest attack. Where necessary, the Client should seek competent advice (e.g., from a licensed or registered plumbing contractor) to determine the adequacy of existing drainage and remove any conditions conducive to the presence of excessive moisture. The building may need to be monitored over a period of time to detect or confirm a damp problem. The presence of dampness (including moisture) is not always consistent as the prevailing and recent weather conditions at the time an inspection is carried out may affect the detection of damp problems. Importantly, precipitation at or near the time of inspection does not necessarily guarantee that a damp problem will automatically be evident due to such circumstances as prevailing wind conditions or intensity of rainfall. The absence of any dampness at the time of inspection does not necessarily mean the building will not experience some damp problems in other weather conditions. Likewise, whether services have been used for some time prior to an inspection being carried out will affect the detection of dampness.

5.3 Ventilation: Not applicable as the home is built on a concrete slab.

Lack of Adequate Subfloor Ventilation Inadequate ventilation provides a condition suitable for timber pest infestation. For example, subterranean termites thrive in damp humid conditions typical of those provided in a poorly ventilated subfloor space. Where evidence of a lack of adequate ventilation has been identified in the report, the Client should seek competent advice (e.g., from a licensed or registered building contractor) in regard to upgrading ventilation.

5.4 Hot water services and air conditioning units: The waste pipe for the pressure relief valve of the hot water system needs to be extended to drain away from the house.

Hot water services and air conditioning units which release water alongside or near to building walls should be piped to a drain (if not possible then several metres away from the building), as the resulting wet area is highly conducive to termites.

5.5 Slab edge exposure: The slab edge inspection zone does not apply to this property.

Where external concrete slab edges are not exposed, there is a high risk of concealed termite entry.

In some buildings built since July 1995, the edge of the slab forms part of the termite shield system. In these buildings an Inspection zone of at least 75mm should be maintained to permit detection of termite entry. The edge should not be concealed by render, tiles, cladding, flashings, adjoining structures, paving, soil, turf, or landscaping etc. Where this is the case, you should arrange to have the slab edge exposed for Inspection.

Concealed termite entry may already be taking place but could not be detected at the time of the Inspection. This may have resulted in concealed timber damage.

NB. A very high proportion of termite attacks are over the slab edge. Covering the slab edge makes concealed entry easy. This is particularly true of infill type slab construction. Termite activity and/or damage may be present in concealed timbers of the building. We strongly recommend frequent regular inspections in accordance with AS 3660.2.

5.6 Weep holes in external walls: Weep holes were clear allowing the free flow of air.

It is very important that soil, lawn, concrete paths, or pavers do not cover the weep holes. Sometimes, they have been covered during the rendering of the brick work. They should be clean and free flowing and covering the weep holes in part or in whole may allow undetected termite entry.

5.7 Termite shields: Not applicable as the home is built on a concrete slab.

Termite Shields (Ant Caps) should be in good order and condition, so termite workings are exposed and visible. This helps prevent termites from gaining undetected entry. Joins in the shielding should have been soldered during the installation. If it is observed that the joins in the shielding have not been soldered, then the shielding must be reported as inadequate. It may be possible for a builder to repair the shielding. If not, a chemical treated zone may need to be installed to deter termites from gaining concealed access to the building. Missing, damaged or poor shields increase the risk of termite infestation. If considered inadequate, a builder or other building expert should be consulted.

Other physical shield systems are not visible to inspection and no comment is made on such systems.

5.8 Bridging or breaching of termite barriers and inspection zones: No bridging or breaching was found.

“Bridging” is the spanning of a termite barrier or inspection zone so that subterranean termites are provided with passage over or around that barrier. “Breaching” is the making of a hole or gap in a termite barrier so that termites are provided with a passage through that barrier.

5.9 Other area(s) and/or situations that appear conducive to (may attract) subterranean termite infestation: Medium to large trees and stumps within a 50 metre radius of the property, due to the nesting conditions. The landscaped timbers, due to the food source.

6.0 OVERALL ASSESSMENT OF THE PROPERTY

6.1 Where evidence of live termites, termite damage or termite workings (mudding) was found in the building(s) then the risk of a further attack is extremely high.

Where evidence of live termites, termite damage or termite workings was found in the grounds but not in the building(s) then the risk to buildings must be reported as high to extremely high.

6.2 At the time of the Inspection, the degree of risk of subterranean termite infestation to the overall property was considered to be **Moderate to High**.

6.3 Subterranean Termite Treatment Recommendation: A management program in accordance with AS 3660-2000 to protect against subterranean termites is considered **not essential, but 6 to 12 monthly inspections are essential**.

6.4 Future Inspections: AS 3660.0-2000 recommends “regular competent Inspections should be carried out at least on an annual basis, but more frequent Inspections are strongly recommended”.

It goes on to inform that “regular Inspections will not prevent termite attack but may help in the detection of termite activity. Early detection will allow remedial treatment to be commenced sooner, and damage to be minimized”.

Due to the degree of risk of subterranean termite infestation noted above and all other findings of this Report; we strongly recommend that a full Inspection and written Report in accordance with AS 4349.3 or AS 3660.2-2000 is conducted at this property every 6 months, but no more than 12 months.

DEFINITIONS

Timber Pest Attack: Means Timber Pest Activity and/or Timber Pest Damage.

Timber Pest Activity: Means telltale signs associated with 'active' (live) and/or 'inactive' (absence of live) Timber Pests at the time of inspection.

Timber Pest Damage: Means noticeable impairments to the integrity of timber and other susceptible materials resulting from attack by Timber Pests.

Major Safety Hazard: Means any item that may constitute an immediate or imminent risk to life, health or property resulting directly from Timber Pest Attack. Occupational, health and safety or any other consequence of these hazards has not been assessed.

Conditions Conducive to Timber Pest Attack: Means noticeable building deficiencies or environmental factors that may contribute to the presence of Timber Pests.

Readily Accessible Areas: Means areas which can be easily and safely inspected without injury to person or property, are up to 3.6 metres above ground or floor levels, in roof spaces where the minimum area of accessibility is not less than 600 mm high by 600 mm wide and subfloor spaces where the minimum area of accessibility is not less than 400 mm high by 600 mm wide, providing the spaces or areas permit entry. The term 'readily accessible' also includes accessible subfloor areas on a sloping site where the minimum clearance is not less than 150 mm high, provided that the area is not more than 2 metres from a point with conforming clearance (i.e., 400 mm high by 600 mm wide); and areas at the eaves of accessible roof spaces that are within the consultant's unobstructed line of sight and within arm's length from a point with conforming clearance (i.e. 600 mm high by 600 mm wide).

Client: Means the person or persons for whom the Timber Pest Detection Report was carried out or their Principal (i.e., the person or persons for whom the report was being obtained).

Timber Pest Detection Consultant: Means a person who meets the minimum skills requirement set out in the current Australian Standard AS 4349.3 Inspections of Buildings. Part 3: Timber Pest Inspection Reports or state/territory legislation requirements beyond this Standard, where applicable.

Building and Site: Means the main building (or main buildings in the case of a building complex) and all timber structures (such as outbuildings, landscaping, retaining walls, fences, bridges, trees, and stumps with a diameter greater than 100 mm and timber embedded in soil) and the land within the property boundaries up to a distance of 50 metres from the main building(s).

Timber Pests: Means one or more of the following woods destroying agents which attack timber in service and affect its structural properties:

Chemical Delignification: The breakdown of timber through chemical action.

Fungal Decay: The microbiological degradation of timber caused by soft rot fungi and decay fungi, but does not include Mould, which is a type of fungus that does not structurally damage wood.

Wood Borers: Wood destroying insects belonging to the order 'Coleoptera' which commonly attack seasoned timber.

Termites: Wood destroying insects belonging to the order 'Isoptera' which commonly attack seasoned timber.

Tests: Means additional attention to the visual examination was given to those accessible areas which the consultant's experience has shown to be particularly susceptible to attack by Timber Pests. Instrument testing of those areas and other visible accessible timbers/materials/areas showing evidence of attack was performed.

Instrument Testing: Means where appropriate the carrying out of Tests using the following techniques and instruments:

- (a) Electronic moisture detecting meter - an instrument used for assessing the moisture content of building elements.
- (b) Stethoscope - an instrument used to hear sounds made by termites within building elements.
- (c) Probing - a technique where timber and other materials/areas are penetrated with a sharp instrument (e.g., bradawl or pocket knife), but does not include probing of decorative timbers or finishes, or the drilling of timber and trees; and
- (d) Sounding - a technique where timber is tapped with a solid object.

IMPORTANT MAINTENANCE ADVICE REGARDING INTEGRATED PEST MANAGEMENT FOR PROTECTING AGAINST TIMBER PESTS

You should read and understand the following important information. It will help explain what is involved in a Timber Pest Inspection, the difficulties faced by a Timber Pest Inspector, and why it is not possible to guarantee that a property is free of Timber Pests. It also details important information about what you can do to help protect your property from Timber Pests. This information forms an integral part of the Report. Any structure can be attacked by Timber Pests. Periodic maintenance should include measures to minimise possibilities of infestation in and around a property. Factors which may lead to infestation from Timber Pests include situations where the edge of the concrete slab is covered by soil or garden debris, filled areas, areas with less than 400mm clearance, foam insulation at foundations, earth/wood contact, damp areas, leaking pipes, etc.; form-work timbers, scrap timber, tree stumps, mulch, tree branches touching the structure, wood rot, etc. Gardens, pathways, or turf abutting or concealing the edge of a concrete slab will allow for concealed entry by timber pests any timber in contact with soil such as form-work, scrap timbers or stumps must be removed from under and around the buildings and any leaks repaired. You should endeavor to ensure such conditions DO NOT occur around your property. We further advise that you engage a professional pest control firm to provide a termite management program in accord with AS 3660 to minimise the risk of termite attack. There is no way of preventing termite attack. Even AS 3660 advises that "the provision of a complete termite barrier will impede and discourage termite entry into a building. It cannot prevent termite attack. Termites can still bridge or breach barriers, but they can be detected more readily during routine inspections."

Reasonable access:

Unless specified in writing, the inspection only covered the Readily Accessible Areas of the Building and Site.

The inspection did not include areas which were inaccessible, not readily accessible or obstructed at the time of inspection. Areas which are not normally accessible were not inspected and include - but not limited to – inside walls, the interior of a flat roof or beneath a suspended floor filled with earth.

Building Interior, the Consultant did not move or remove any ceilings, wall coverings, flooring, floor coverings (including carpeting), furnishing, equipment, appliances, pictures, or other household goods. In an occupied property, furnishings or household items may be concealing evidence of timber pest attack which may only be revealed when the items are moved or removed.

Building Exterior, Roof Exterior and Site, the Consultant did not move or remove any obstructions such as wall cladding, awnings, trellis, earth, plants, bushes, foliage, stored materials, debris, or rubbish. Due to the 'secretive' nature of timber pests, it is possible that hidden damage may exist in concealed areas, e.g., wall framing. Damage may only be found when the obstruction is removed. In the case of buildings constructed on concrete slabs, if the edge of the slab or any weep hole or vent at the base of external walls is concealed by pavements, gardens, lawns, or landscaping then it is possible for termites to gain undetected entry into the building. The building of gardens or planting of shrubs close to the perimeter of the building can promote and conceal termite entry points. The storage of cellulose materials such as building materials and firewood near the ground or building may encourage termite activity.

Roof Space Obstructions such as roofing, stored articles, thermal insulation, sarking, and pipe/duct work may be concealing evidence of timber pest attack which may only be revealed when the obstructions are moved or removed. Also, bodily access should be provided to the interior of all accessible roof spaces. In accordance with Australian Standard ASS 4349 the minimum requirement is a 400mm by 500 mm access manhole.

Subfloor Space Subfloor areas should be kept free from all vegetation (including tree stumps) and other cellulose material which may encourage timber pest activity. Also, storage of materials in subfloor areas is not recommended as it reduces ventilation and makes inspection difficult. Obstructions may be concealing evidence of timber pest attack which may only be revealed when the obstructions are moved or removed. Bodily access should be provided to all accessible subfloor areas with the minimum requirement being a 500 mm x 400 mm access manhole. In the case of suspended floors, if the clearance between the ground and structural components is less than 400 mm, then the ground should be excavated to provide the required clearance, subject to maintaining adequate drainage and support to footings. If the subfloor has been sprayed for subterranean termites or if the area is susceptible to mould growth, appropriate health precautions must be followed before entering the area. Also, special care should be taken not to disturb the treated soil. Always seek further advice from the Consultant.

A further inspection is strongly recommended of those areas that were not readily accessible and of inaccessible or obstructed areas once access has been provided or the obstruction removed. This will involve a separate visit to the site, permission from the owner of the property and additional cost.

Unless stated otherwise, any recommendation or advice given in this Report should be implemented as a matter of urgency.

A more invasive physical inspection is available and recommended:

As detailed above, there are many limitations to this visual inspection only. With the permission of the owner of the premises we WILL perform a more invasive physical inspection that involves moving or lifting insulation, stored items, furniture, or foliage during the inspection. We WILL physically touch, tap, test and when necessary, force/gouge suspected accessible timbers. We WILL gain access to areas, where physically possible and considered practical and necessary, by way of cutting traps and access holes.

This style of Report is available by ordering with several days' notice. Inspection time for this style of Report will be greater than for a VISUAL INSPECTION.

It involves disruption in the case of an occupied property, and some permanent marking is likely. You must arrange for the written permission of the owner who must acknowledge all the above information and confirm that our firm will not be held liable for any damage caused to the property.

A price is available on request.

Concrete slab homes:

Homes constructed on concrete slabs pose special problems with respect to termite attack. If the edge of the slab is concealed by concrete paths, patios, pavers, garden beds, lawns, foliage, etc. then it is possible for termites to affect concealed entry into the property, and they can then cause extensive damage to concealed framing timbers. Even the most experienced Inspector may be unable to detect their presence due to concealment by wall linings. Only when the termites attack timbers in the roof void, which may in turn be concealed by insulation, can their presence be detected. Where termite damage is in the roof, it should be expected that concealed framing timbers will be extensively damaged. With a concrete slab home, it is imperative that you expose the edge of the slab and ensure that foliage and garden beds do not cover the slab edge. Weep holes must be kept free of obstructions.

It is strongly recommended that you have a Termite Inspection in accordance with AS 3660.2 carried out every 6 to 12 months.

Subterranean termites:

No property is safe from termites. General Description of Attack Timber hollowed beneath; some cracking at the surface of timber; earthen channels present; or pale faecal spots present.

Important note:

As a delay may exist between the time of an attack and the appearance of telltale signs associated with the attack, it is possible that termite activity and damage exists though not discernible at the time of inspection.

Treatment After discovery of an active infestation, it is imperative that the species of termite is accurately identified before costly (and sometimes unnecessary or inappropriate) methods of treatment are initiated. Only economically important species which are known to attack timber structures should be treated.

In the case of economically important species, it is important that the termite workings are not further disturbed until the proposed method of control has been determined by a licensed pest control operator. Premature attempts to repair or replace infested timber may cause the termites to withdraw from the area temporarily, thereby hindering effective treatment. Any repair or replacement of infested timber should be carried out after the appropriate treatment has been completed.

Where evidence of active termites is detected within a building or within 50 metres of any building, it must always be assumed that the termites may also be active in areas of the property not inspected. Accordingly, where the termites are known to be of economic significance, a further (more invasive) inspection is strongly recommended of areas which were inaccessible, not readily accessible or obstructed at the time of inspection.

Termite Workings and Damage Where evidence of damage to building timbers exists, competent advice (e.g. from a licensed or registered building contractor) should be obtained to determine the extent of any structural damage and as to the need or otherwise for rectification or repair work.

Where evidence of inactive termites is located within the building, it is possible that termites are still active in areas of the property not inspected and they may continue to cause damage. A furthermore invasive inspection is strongly recommended of areas which were inaccessible, not readily accessible or obstructed at the time of inspection.

Where evidence of an inactive termite infestation exists, it is not possible, without benefit of further investigation and inspections over a period, to ascertain whether any infestation is active or inactive. Continued, regular, inspections are essential.

Where evidence of termite attack exists to any trees or tree stumps a more conclusive search should be undertaken. This may require the tree or stump to be drilled to determine the existence of a termite nest. In addition, the soundness and stability of any standing trees identified as being affected by termite attack should be confirmed. Always seek further advice from the Consultant.

Previous Treatments Where evidence of a possible termite treatment was located, the Client should obtain and keep on file all relevant documents pertaining to the extent of the treatment, any service warranties and advice in regard to the building owner's obligation to maintain the treatment and/or barrier. If evidence of a previous treatment of termite infestation is noted, and appropriate documentation is not available, the Client must assume that the termite infestation may still be active in areas of the property not inspected. Accordingly, a re-treatment may be required. Always seek further advice from the Consultant.

Frequency of Future Inspections Australian Standard AS 3660 recognises that regular inspections will not prevent termite attack but may help in the detection of termite activity. Early detection will allow remedial treatment to be commenced sooner and damage to be minimised.

Inspections at intervals not exceeding twelve (12) months are recommended. Where the termite risk is high or the building type susceptible to termite attack, more frequent inspections (3-6 months) should be undertaken.

Risk management options:

To help protect against financial loss, it is essential that the building owner immediately control or rectify any evidence of destructive timber pest activity or damage identified in this inspection report. The Client should further investigate any high-risk area where access was not gained. It is strongly advised that appropriate steps be taken to remove, rectify or monitor any evidence of conditions conducive to timber pest attack.

To help minimise the risk of any future loss, the Client should consider whether the following options to further protect their investment against timber pest infestation are appropriate for their circumstances:

Undertake thorough regular inspections at intervals not exceeding twelve months or more frequent inspections where the risk of timber pest attack is high, or the building type is susceptible to attack. To further reduce the risk of subterranean termite attacks, implement a management program in accordance with Australian Standard AS 3660. This may include the installation of a monitoring and/or baiting system, or chemical and/or physical barrier. However, AS 3660 stresses that subterranean termites can bridge, or breach barrier systems and inspection zones and that thorough regular inspection of the building are necessary.

CONTACT THE INSPECTOR

Please feel free to contact the Inspector who carried out this inspection. Often it is very difficult to fully explain situations, problems, access difficulties or timber pest activity and/or damage in a manner that is readily understandable by the reader. Should you have any difficulty in understanding anything contained within this Report, then you should immediately contact the Inspector and have the matter explained to you.

If you have any questions at all or require any clarification, then contact the Inspector prior to acting on this Report.

NOTICE TO THE PURCHASER

(a) Prior to or on Exchange, and prior to the commencement of the 'Cooling-off Period', you were given an Inspection Report on the Property you intend on purchasing ("the Report"). The Purchaser is advised that this Report reflects the condition of the property existing at the time of the Inspection (Inspection Date) and may not reflect the current state. Timber Pests, particularly Termites, may have gained entry to the property since the Inspection Date. Termites can, in a relatively short period, cause significant damage to both structural and non-structural timbers within and around the buildings of the Property.

Termites (white ants) may be difficult to detect and much of the damage caused may not be readily visible. If damage exists, then it may cost thousands of dollars to repair.

It is, therefore, very strongly recommended that you urgently arrange for another Inspection and Report in accordance with AS4349.3 to be carried out prior to exchange, or prior to the expiration of any 'Cooling off Period', and prior to settlement.

(b) If the Report indicated the presence of Termites, termite damage or recommends any treatments or other Inspections and Reports, you should obtain copies of the treatment proposal, any certificates of treatments carried out, details of all repairs including copies of quotations, invoices, and any other Reports.

It is strongly recommended that you arrange for an Inspection and Report in accordance with AS 4349.3 to verify that the treatment has been successful and carried out in accordance with AS 3660.2 and a further building Inspection in accordance with AS 4349.1.

(c) If you fail to procure a further Inspection and report as recommended in (a) and (b), or fail to obtain copies of the treatment proposal, certificates of treatment carried out, details of all repairs including copies of quotations, invoices and any other reports as recommended in (b) above, then it will be deemed that you have decided not to have a further Inspection and report carried out, or to obtain copies of certificates of treatments carried out, details of all repairs including copies of quotations, invoices and any other reports.

It will be deemed that you have relied upon your own enquiries and the report, knowing the possible consequences and that the condition of the property, as stated in the report, may have changed.

(d) The person carrying out the Inspection and the company, partnership or sole trader that employs that person will have no liability to you for any damage or loss you may suffer as a result of your entering the contract to purchase the property or in connection with completing the purchase of the property as a result of your failure to heed the advice given in (a) and (b) and the warning contained in (c) above, and may use such failure in defense of any claim that you may later make against any of them.

Compliance Report



COMPLIANCE REPORT

This is a Compliance Report regarding any unapproved structures or alterations. ACT Property Inspections have accessed the attached Building File from ACT Planning and Land Authority (ACTPLA) and hold no responsibility for any inaccuracies in the Building File supplied by ACTPLA. The Compliance report is based solely upon the information available from the Building File which does not contain information regarding Plumbing or Electrical work that has taken place since the original construction. Information regarding the Plumbing and Electrical is available upon application from ACTPLA. Since we are not Plumbers or Electricians, we are unable to comment on those works. If structures have been noted as requiring approval, a Certifier should be engaged to assess if the structure will comply with the relevant ACT legislation. Owners must be aware that unapproved structures may not comply and may require significant repair, design change or possible removal.

Property Address: 89 Barr Smith Avenue, Bonython ACT 2905
Block & Section: Block 2 Section 23 BONYTHON
Inspection Date: Wednesday, April 8th 2026

APPROVAL STATUS

Description	Plan number	Certificate of occupancy date	Approval status
New Residence	79057	08/03/1991	Approved.
Metal Carport	79057/A	27/11/1991	Approved.
External structures: <ul style="list-style-type: none"> • Pergola • Garden shed • Rear retaining walls 	-	-	These structures are exempt from approval. No action is required.

SURVEY REPORT

Survey Report completed by	Date Survey report was completed	Comments
Sowden, Lilley & Associates	Friday, 14 December 1990	There are no apparent encroachments upon this land or by this property on adjoining lands or street.

Conveyancing File

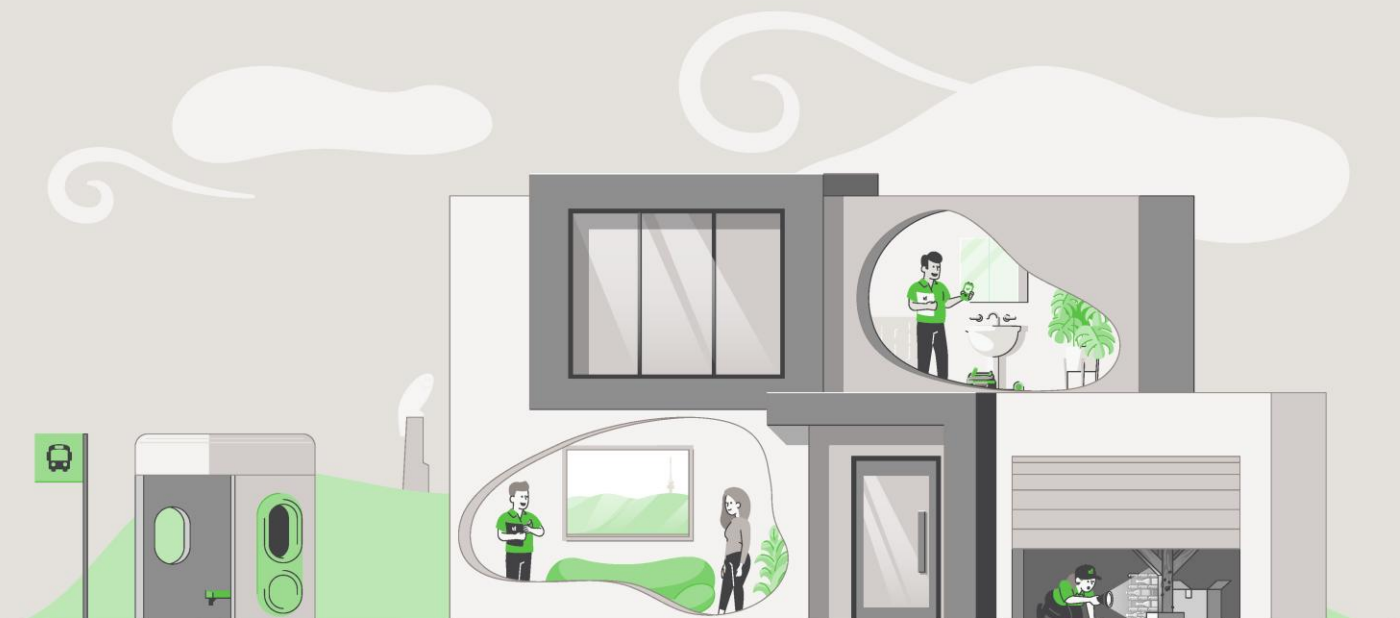

CONVEYANCING BUILDING FILE INDEX

SUBURB: **BONYTHON** SECTION: **23** BLOCK: **2** UNIT: **N/A** EX GOV: **NO**

COU ISSUED Y/N	PLAN NUMBER	FOLIO NO.	DESCRIPTION OF WORK	AMEND	DETAILS	PERMIT NUMBER	COU PLAN NO. & DATE
Y	79057	3	NEW RESIDENCE				
		8				79057	
		26					79057 08/03/1991
Y	79057/A	28	METAL CARPORT				
		34				79057/A	
		39					79057/A 27/11/1991

For any incomplete approvals please email acbuildingconveyance@act.gov.au for further information on how to complete.

Drainage Plan Number: 54136

Survey: Y (1)

Comments:

CONVEYANCING PART 2

No information is provided in respect of electrical, drainage or sewer matters and or to the location of overhead power lines or underground cables in relation to the building.

- | | <u>Yes</u> | <u>No</u> |
|---|--------------------------|-------------------------------------|
| 1. (a) Is this a government or ex government house? | <input type="checkbox"/> | <input checked="" type="checkbox"/> |
| (b) If yes, is there a building file with approvals on it? | <input type="checkbox"/> | <input type="checkbox"/> |
| 2. Is there any record of incomplete building work on the building file?
If yes - file copies attached | <input type="checkbox"/> | <input checked="" type="checkbox"/> |
| 3. Are there any records on the building file of current (within 5 years) housing Indemnity insurance policies for building work? If yes - file copies attached | <input type="checkbox"/> | <input checked="" type="checkbox"/> |
| 4. Are there any records on the building file showing building applications still being processed? (Current within 3 years) If yes - file copies attached | <input type="checkbox"/> | <input checked="" type="checkbox"/> |
| 5. Are there any records on the building file in relation to loose-fill asbestos insulation? | <input type="checkbox"/> | <input checked="" type="checkbox"/> |

If available, copies of the following documents are provided:

- | | | |
|--|-------------------------------------|-------------------------------------|
| • Certificate/s of Occupancy and Use | <input checked="" type="checkbox"/> | <input type="checkbox"/> |
| • Survey Certificates | <input checked="" type="checkbox"/> | <input type="checkbox"/> |
| • Unit Plan/Unit Entitlements (if property is unit titled) | <input type="checkbox"/> | <input checked="" type="checkbox"/> |
| • Approved Building Plans | <input checked="" type="checkbox"/> | <input type="checkbox"/> |
| • Ex- government Building Plans* | <input type="checkbox"/> | <input checked="" type="checkbox"/> |

If requested:

- | | | |
|--------------------|-------------------------------------|--------------------------|
| • Drainage Plan(s) | <input checked="" type="checkbox"/> | <input type="checkbox"/> |
|--------------------|-------------------------------------|--------------------------|

ASBESTOS

The ACT Government is not able to guarantee the accuracy of the information in this report.

You should make your own enquiries and obtain reports (from a licensed Asbestos Assessor) in relation to the presence of loose fill asbestos insulation (and other forms of asbestos) on the premises. For more information go to the Asbestos Awareness Website –

www.asbestos.act.gov.au

Please note: Development Approval plans will not be included in this report (We do not receive Development Approval Plans unless they are part of a Building Approval in which case they become Building Approval Plans), if development approval was granted you can request copies of the Development Approval plans from ACEPDcustomerservices@act.gov.au.

Please Note: Building approvals that have been generated via eDevelopment will be issued with a project number prefixed by the letter B. Initial building approval documentation will be identified with project number B20XXXXX only but will be referenced as B20XXXXX/A on the Certificate of Occupancy and Use. Any amendments to the original approval will be issued with the project number and an alphanumeric digit. The first amendment will be identified as B20XXXXX/B, the second amendment B20XXXXX/C etc. Not all eDevelopment plans will be stamped with the plan number.

*Ex Government plans: Plans are typical and not specific to each residence. There may be slight changes to the layout or window locations that were not required to be approved.

Search officer comments (if any?)

Search officer initials: Kayne

Cost of application: \$ 144.79

Date completed:

25/03/2026

SOWDEN, LILLEY & ASSOCIATES PTY. LTD.
CONSULTING LAND SURVEYORS
34 BOUGAINVILLE STREET
MANUKA, A.C.T. 2603



TELEPHONE 295 9468

P.O. BOX 3277
MANUKA, A.C.T. 2603

Directors:

GRAHAM SOWDEN, M.I.S. (Aust.)
DESMOND J. LILLEY, M.I.S. (Aust.)

PRIVATE TELEPHONES
295-9142
288-4261

REF. 19887

14th December 1990

The Manager
A & D Constructions
PO Box 231
WANNIASSA ACT 2903

Dear Sir,

I have surveyed Block 2, Section 23, Division of BONYTHON in the Tuggeranong District, Australian Capital Territory as delineated on Deposited Plan No.7545, containing an area of 860 square metres and having a frontage of 23.005 metres to Barr-Smith Avenue, such being shown by red edging on the sketch plan endorsed hereon.

Upon this land stands a residence in the course of erection. The sketch shows the position of the residence relative to the boundaries.

The residence is erected wholly within the boundaries of the land.

The land is fenced as shown on the sketch.

There are no encroachments by or upon the subject land.

Yours faithfully,

[Signature]
REGISTERED SURVEYOR.

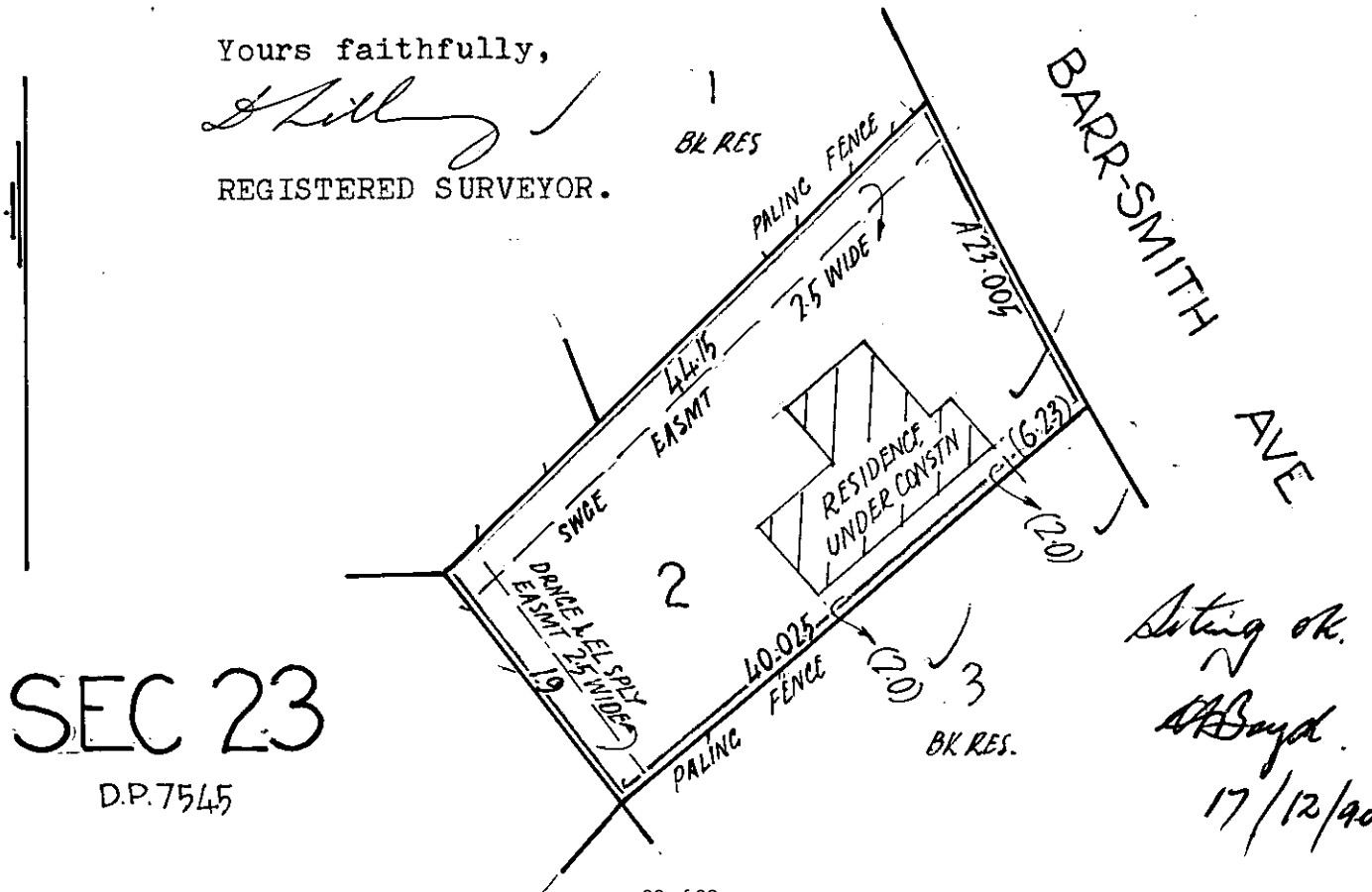

SEC 23
D.P. 7545

Siting ok.
W Boyd.
17/12/90

Sib

PLANS/FILE No. 79057
Received Building Control
31 OCT 1990
ACT Administration

ACT BUILDING CONTROL

Lodged/...../.....
Sent/...../.....
to

<input checked="" type="checkbox"/> ITPA	<input type="checkbox"/> Roads
<input type="checkbox"/> Elect	<input type="checkbox"/> Maintenance
<input type="checkbox"/> Struct	<input type="checkbox"/> Water
<input type="checkbox"/> Other	<input type="checkbox"/> Relevel

DUE / /

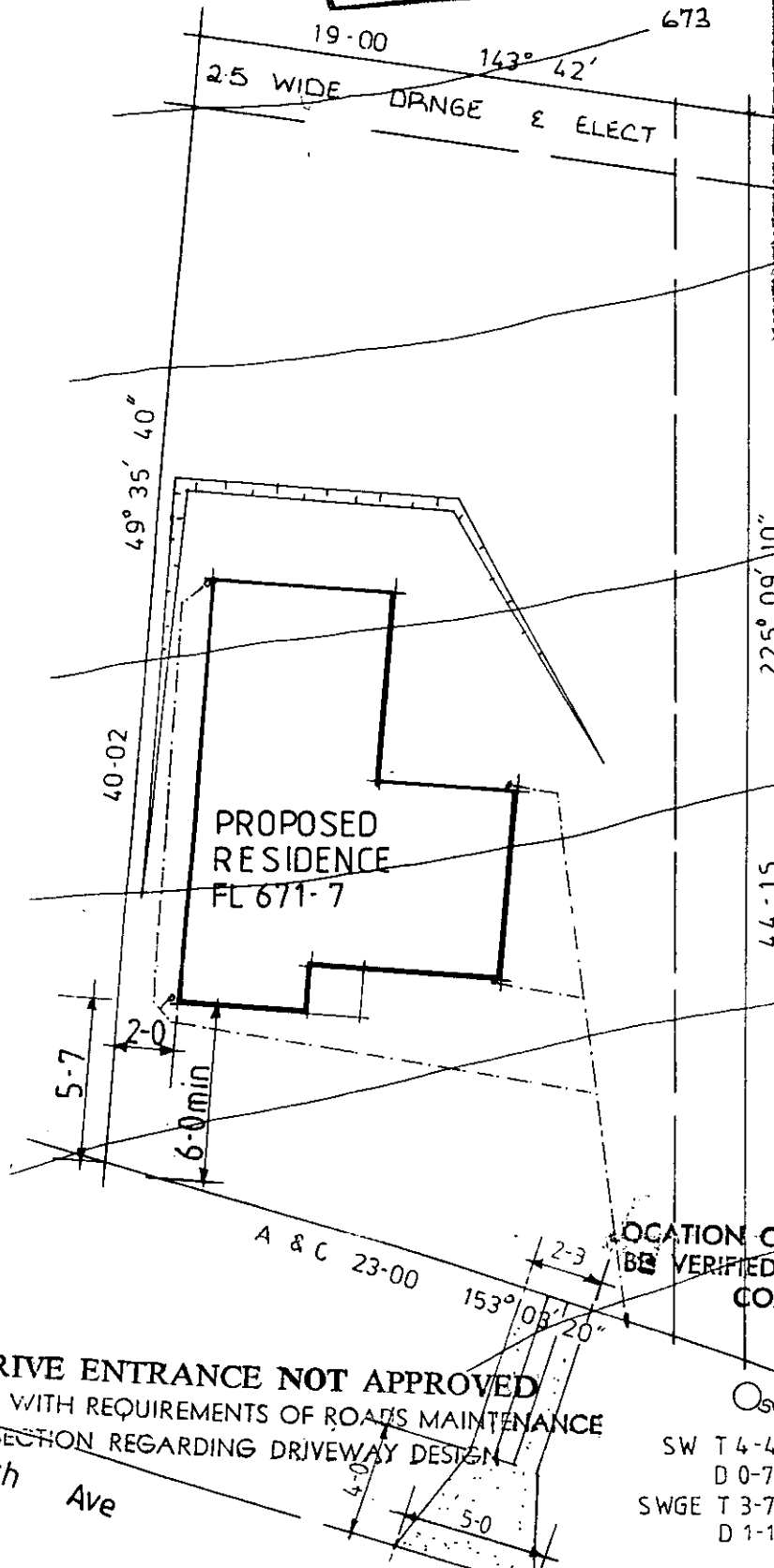

BUILDINGS (DESIGN AND SITING)
ORDINANCE 1984 AS AMENDED
APPROVAL GRANTED

12 NOV 1990
671-5

INTER-TERRITORIAL PLANNING AUTHORITY

Area 860 sqm
Plot ratio 301sqm

DRIVE ENTRANCE NOT APPROVED
CONFLICT WITH REQUIREMENTS OF ROADS MAINTENANCE
SECTION REGARDING DRIVEWAY DESIGN
Barr Smith Ave

PROPOSED RESIDENCE
Block 2 Section 23 Bonython
A & D Constructions

JAB DRAFTING SERVICE
4 PHELAN PLACE WANNIASSA
PH & FAX 231 0629

SCALE 1:250
DATE SEPT 90
DRAWN S.P.

1-2067

2/6

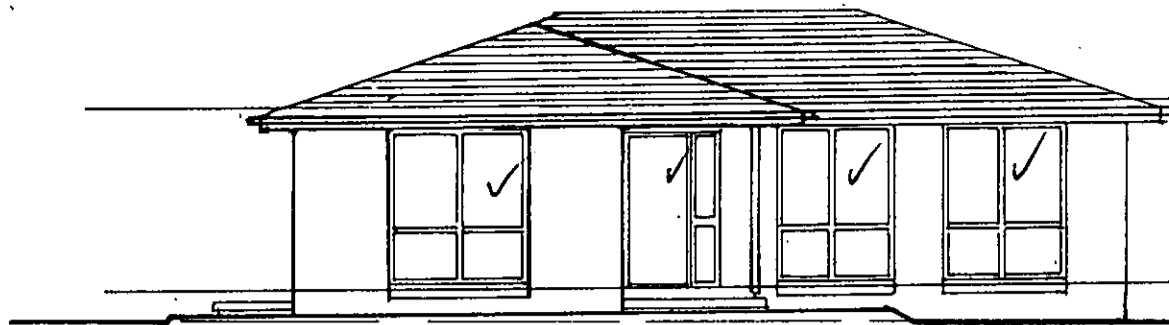

PLANS/FILE No. 79057.....
 Received Building Control
 31 OCT 1990
 ACT Administration

N.E. ELEVATION

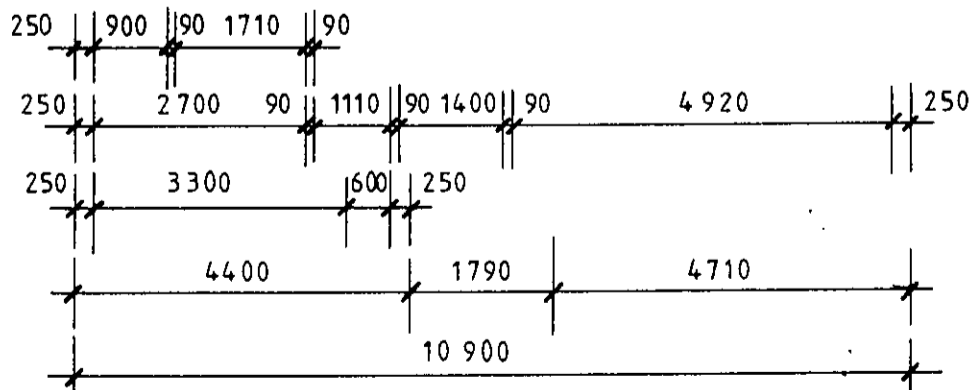
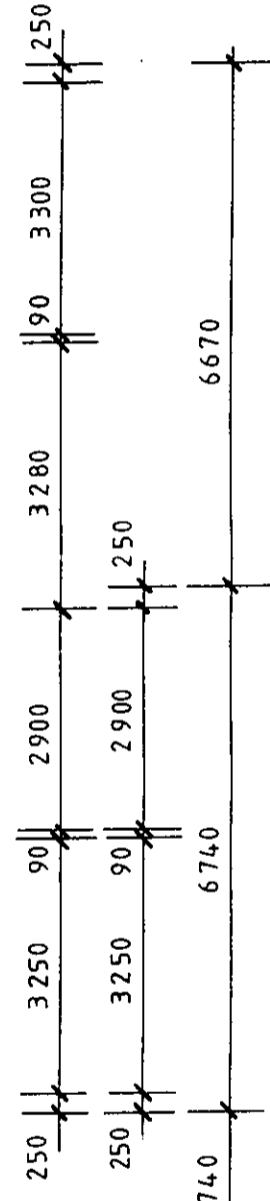
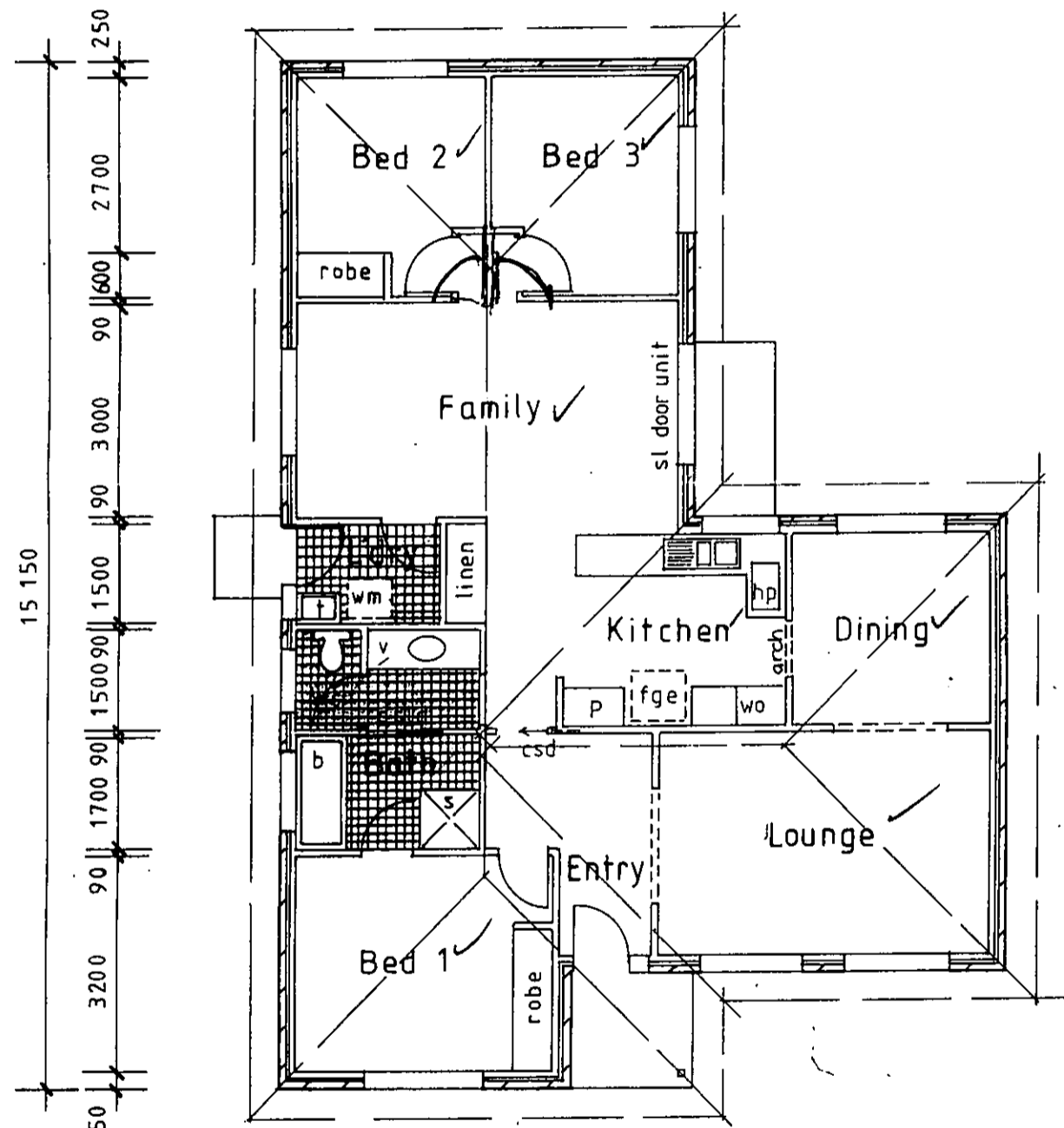
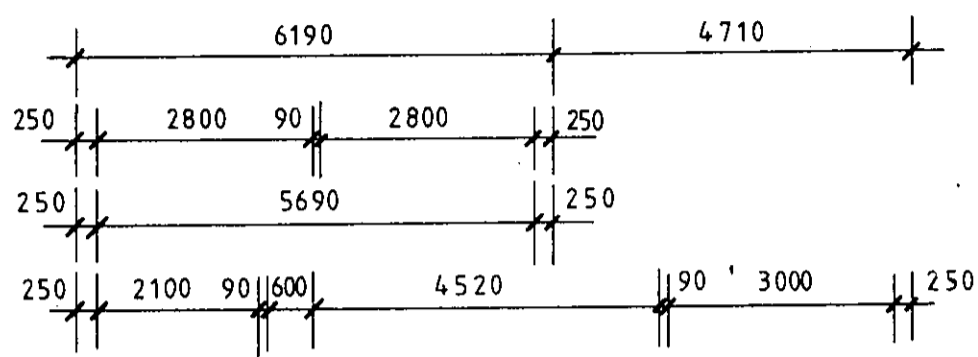

BUILDINGS (DESIGN AND SITING)
 ORDINANCE 1984 AS AMENDED
 APPROVAL GRANTED
 12 NOV 1990
 INTERIM TERRITORY
 PLANNING AUTHORITY
 ALL DIMENSIONS, LEVELS, ASPECTS
 ETC. TO BE VERIFIED ON SITE BY
 BUILDER/OWNER BEFORE COMMENCING
 CONSTRUCTION.

WET AREAS..... TO COMPLY WITH PART
 F1.7 BUILDING CODE OF AUSTRALIA

FLOOR PLAN
 AREA 122-409

J.A.B. DRAFTING SERVICE 4 PHELAN PLACE WANNIASSA Ph2310629			
PROPOSED RESIDENCE		SCALE	1:100
		DATE	SEPT 90
Block 2 Section 23 Bonython A & D Constructions		DRAWN	PETERS
		DWG NO	JOB NO
		2	2067

PLANS/FILE No. 79057
 Received Building Control
 31 OCT 1990
 ACT Administration

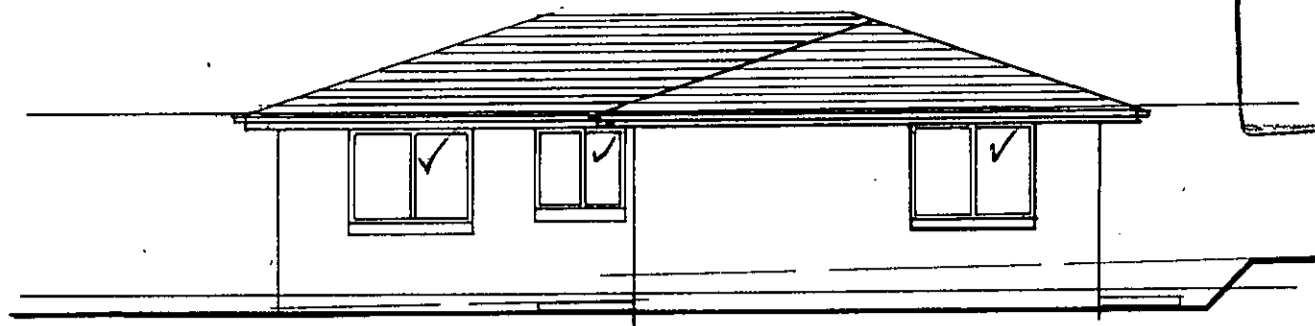

S.W. ELEVATION

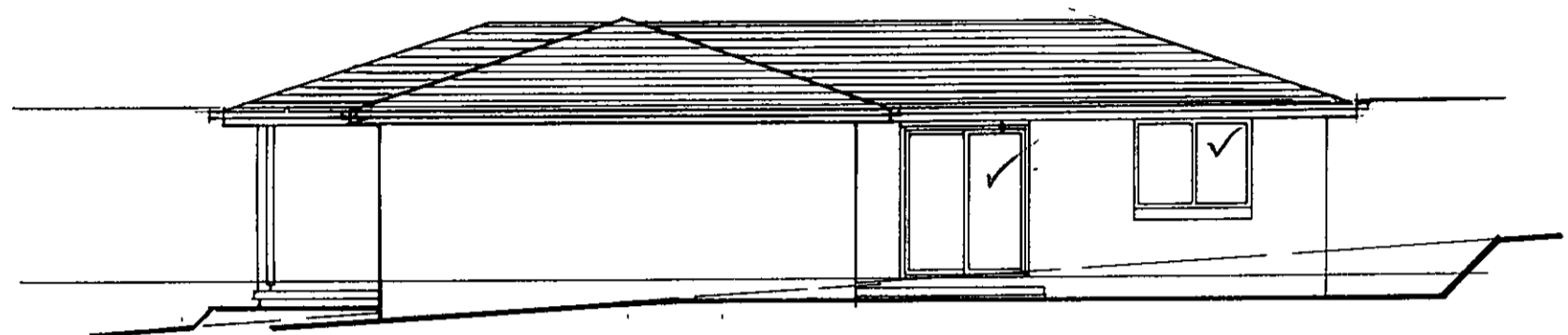

N.W. ELEVATION

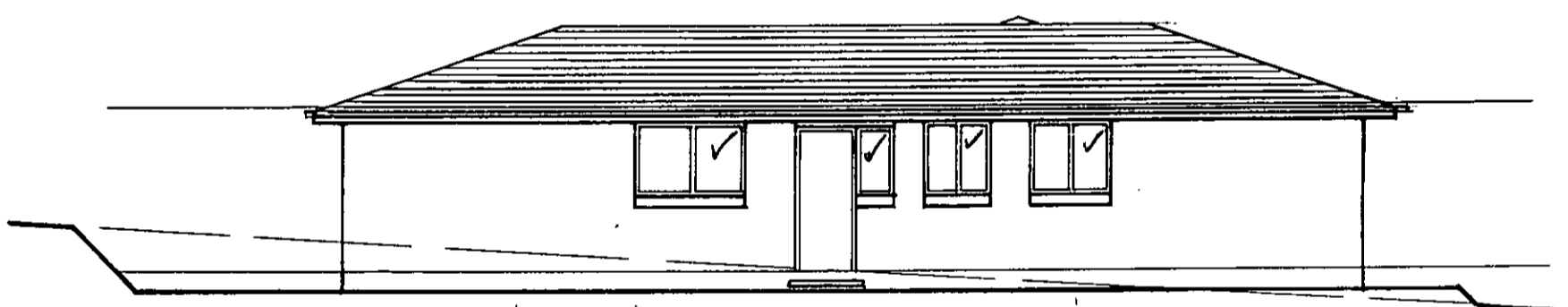

S.E. ELEVATION

CONSTRUCTION MUST COMPLY WITH A.S. 1684.—1979
 Timber framing code and relevant supplements

90x35 PINE PLATES AND NOGGINGS. PROVIDE DOUBLE TOP PLATES TO LOAD BEARING WALLS.
 90x35 PINE STUDS AT 450 CTS TO LOAD BEARING WALLS AND AT 600 CTS TO NON-LOAD BEARING WALLS.

PLASTER BOARD INTERNAL WALL AND CEILING LINING CEMENT SHEET INTERNAL WALL LINING TO WET AREAS.

FACE BRICK EXTERNAL SKIN AS SELECTED.

CONC SLAB IN ACCORDANCE WITH S.A.A CODE 2870-1.

PROVIDE CONTINUOUS DAMPPROOF MEMBRANE UNDER SLAB.

Submit Certification from timber roof truss manufacturer stating that fabricated trusses complies with relevant Australian Standards.

18.4° ROOF PITCH
 CONC ROOF TILES AS SELECTED.
 PREFABRICATED ROOF TRUSSES AT 900 MAX CTS.

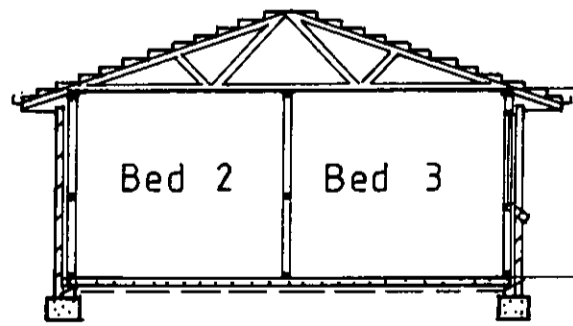

SECTION

LINTEL SIZES AS PER BUILDING TRUSS MANUFACTURER'S CHARTS. APPROVAL GRANTED

12 NOV 1990

ACT TERRITORY PLANNING AUTHORITY

CONC FOOTINGS IN ACCORDANCE WITH S.A.A CODE 2870-1.

J.A.B. DRAFTING SERVICE 4 PHELAN PLACE WANNIASSA Ph2310629			
PROPOSED RESIDENCE	SCALE	1:100	
	DATE	SEPT 90'	
Block 2 Section 23 Bonython A & D Constructions	DRAWN	PETERS	
	DWG NO	3	JOB NO 2067



Department of Urban Services
ACT Building Control

39

Certificate of Occupancy or Use

Pursuant to Part V of the Building Act 1972, the Building works consisting of

METAL CARPORT

Situated at

Suburb BONNITHON	Section 23	Block 2	Unit
---------------------	---------------	------------	------

and

Approved Plan No. 79057/A	Type of Construction*
------------------------------	-----------------------

Class of Occupancy* 10	Permit No. 5415	Name of Permit Holder MASTERBUILT GARAGES
---------------------------	--------------------	--

*as defined under the Building Act 1972

is considered to be in accordance with the prescribed requirements and is certified as

- fit for occupancy or use pursuant S 53(2)
- fit for occupancy or use pursuant S 53(3)
- fit for occupancy or use pursuant S 53(4) subject to the endorsements listed below
- fit for occupancy or use of part of the building pursuant to S 53(6)
- completed pursuant to S 53(10)
- completed pursuant to S 53(11)

Endorsements pursuant to notice under Section 53(4)

85346

Deputy Building Controller

	27/11/191
--	-----------

The issue of this Certificate does not affect the liability of a person to comply with the provisions of a law of the Territory (including the Building Act) relating to the building work nor does it authorise the use of the land contrary to a provision, covenant or condition of lease.

This is a valuable document
44 of 62
keep it in a safe place

Sib

NEW WORK NEW BUILDING PERMIT REQUIRED

END VIEW

SIDE VIEW

Times No. 79957A
 Pj No.
 Plan Seq No.
 PLANS/SIDE No.
 28 AUG 1991
 Received ACT Building Control
 ACT Government

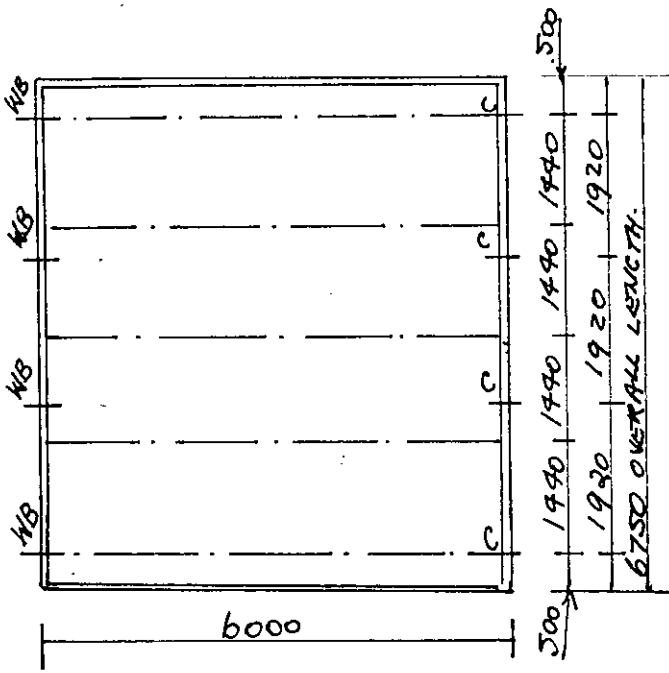

PLAN

BUILDING CONTROL

to

ITA Roads
 Eect Maintenance
 Struct Water
 Other Removal

DUE / /

NO PART OF THE STRUCTURE/FOOTINGS TO ENCROACH THE BOUNDARY.

"NO SURVEY CERTIFICATE REQUIRED."
 LESSEE/BUILDER RESPONSIBLE FOR CORRECT SITING

NATURAL GROUND LEVELS AT SITE BOUNDARIES AND EASEMENTS SHALL NOT BE ALTERED

89 BARR SMITH CR

APPROVED FOR CONSTRUCTION BY THE HOLDER OF A "D" CLASS LICENCE.
 TYPE OF CONSTRUCTION REQUIRED.
 CLASS OF OCCUPANCY.

P. Davis 16.10.91
 DEPUTY BUILDING CONTROLLER UNDER BUILDING ACT 1972.

BUILDINGS (DESIGN & SITING)
 ACT 1964 (AS AMENDED)
APPROVAL GRANTED
 PURSUANT TO SECTION 6

15 OCT 1991

[Signature]

AUSTRALIAN CAPITAL TERRITORY
 PLANNING AUTHORITY

THIS APPROVAL DOES NOT SUPERSEDE THE REQUIREMENTS OF THE BUILDING CODE OF AUSTRALIA

E. KOWALSKA.	Block 2	Section 23	Suburb BONYTHON
Masterbuilt Garages Pty. Limited 32 Aurora Avenue Queanbeyan 2620	Phone : (06) 299 1800 Fax: (06) 299 1863	Scales: 1:100 1:250	27/10/91

INSTALL TO MANUFACTURER'S SPECIFICATION

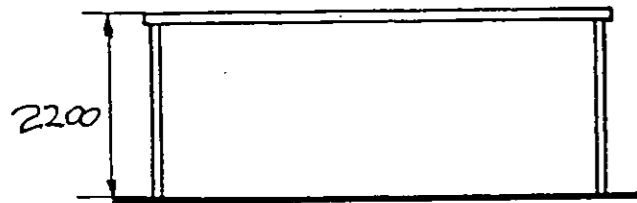

END VIEW

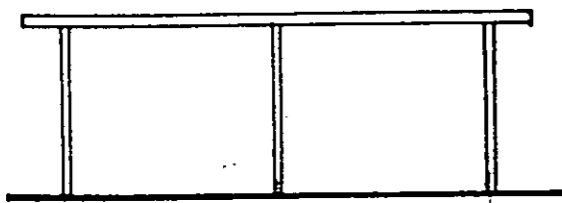

SPACES AT 2775 MAX

SIDE VIEW

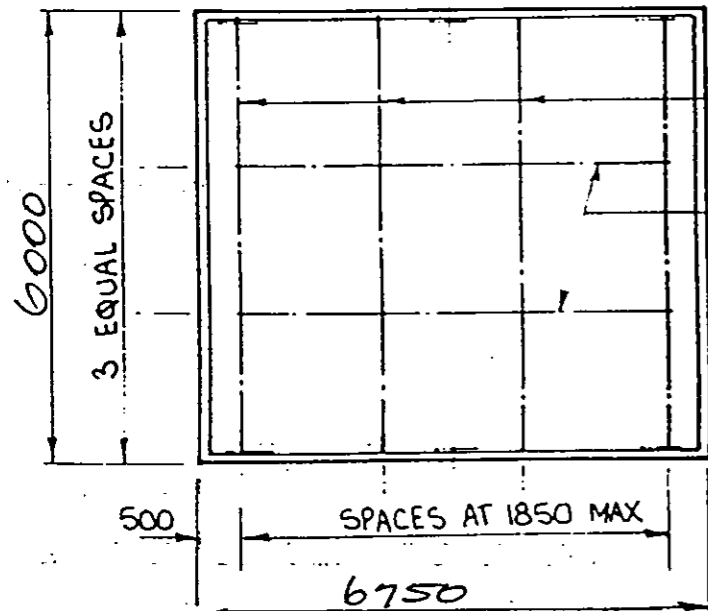

PLAN

WALL FIXED AT 2 OR MORE POINTS 1800 CENTRES *

0.62 STEEL STRAMIT GUTTER ALL ROUND (STRUCTURAL)

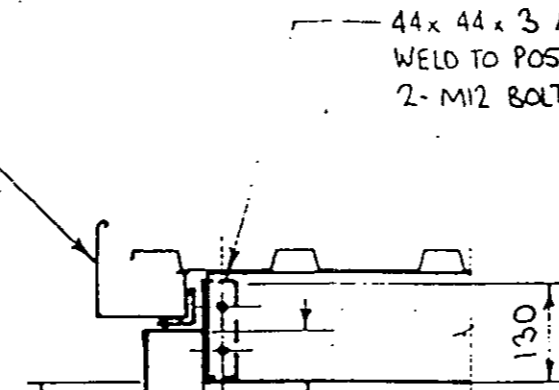

44x44x3 ANGLE CLEAT WELD TO POST & SEAT ANGLE 2-M12 BOLTS TO PURLIN

44x44x3 ANGLE SEAT WELD TO POST CAP & 2-M12 BOLTS TO GUTTER ANGLE

HEIGHT: 2100 MIN.

POST - SEE TABLE 3 CAP & ANGLE OR RHS CROSS PIECE 125 LONG, WELD TO BASE

FINISHED GROUND OR SLAB LEVEL

DEPTH D SEE TABLE

BASE B SQ SEE TABLE

Trims No. 79087A
Prj No. 5415
Plan Seq No. S821
FLANSIT 3 No. 28 AND 1111

44x44x3 ANGLES WELDED TOGETHER. 2-M12 BOLTS TO PURLIN, 2-M12 BOLTS TO GUTTER ANGLE

44x44x3 ANGLE CONTINUOUS BETWEEN POSTS (& PROJECT 125 BEYOND POST & RIVET TO GUTTER 3 DIA RIVETS AT 250 CRS IN EACH LEG

NOTES

- CONSTRUCTION TO BE TO ACT BUILDING MANUAL/NSW ORD.70.
- DESIGN LOADS ARE TO AS1170 PTS. 1 & 2, TERRAIN CAT. 3 50 YR RETURN VELOCITY 38 m/sec., AND 44 m/sec. WITH VARIATIONS AS NOTED.
- FABRICATION TO BE TO AS1250 & AS1554, WELDS 2 mm CONTINUOUS OR BUTT. ELECTRODES GRADE E48.
- RHS SECTIONS TO BE TUBELINE 350 (YIELD 350 MPa), EXCEPT 89 x 89 AND 102 x 102 RHS MAY BE GRADE 250 (YIELD 250 MPa)
- M12 BOLTS MAY BE REPLACED BY SITE WELDING 75 mm MINIMUM OF WELD TO NOTE 3 FOR EACH PAIR OF M12 BOLTS.
- REMOVE WELD SCALE AND SHOP PRIME STEELWORK.
- POST FOOTING DEPTH MAY BE REDUCED BY 100 mm PROVIDED CARPORT SLAB IS PLACED OVER FOOTING BEFORE FINAL BUILDING INSPECTION. AREA MAY BE REDUCED BY 50 mm EACH WAY FOR 38 m/sec. WIND VELOCITY DISTRICTS.
- ROOFING: COLORBOND OR ZINCALUME HIGH TENSILE G550, D.42 BASE STEEL, LBI "TRIMDEK" OR KH "K-CLAD". FIX SHEETS TO GUTTERS AND PURLINS TO MANUFACTURER'S INSTRUCTIONS.
- FALL ROOF TO FRONT OR REAR TO SUIT STORMWATER, CONNECT DOWNPIPES TO EXISTING STORMWATER SYSTEM.

BUILDINGS (DESIGN & STAMP) ACT 1991 (AS AMENDED) APPROVAL GRANTED PURSUANT TO SECTION 38(1) OF THE ACT
15 OCT 1991
AUSTRALIAN CAPITAL TERRITORY PLANNING AUTHORITY

Changes to table as engineer's calculation

Ray Franz 20/8/90

SEE CERTIFICATE DATED 20/8/90
RAY FRANZI M.I.E.AUST.
CONSULTING ENGINEER
RAY FRANZI PTY. LIMITED BOWTHORNS

FOR FREESTANDING CARPORTS. CAT 3 ONLY.

HEIGHT TO	POST	FOOTING * BASE B	DEPTH D
3000	75x75x2.5 RHS	400	450
3600	75x75x3.0 RHS	400	500
3600	75x75x2.5 RHS	450	500

E. KOWALSKA BLOCK 2 SECTION 23
STEEL FRAME CARPORT TO 6000 WIDE
MASTERBUILT GARAGES HL 32 AURORA AVE QUEANBEYAN 2620
RAY FRANZI M.I.E.AUST. CONSULTING ENGINEER PH: 61 1140
RAY FRANZI PTY. LIMITED
SCALE 1:100
D.D. No. G331

PLAN OF SANITARY DRAINAGE

For
A & D CONSTRUCTIONS

Block 2 Section 23 BONYTHON

Scale 1:200

All work must be carried out in conformity with the
Canberra Sewerage and Water Supply Regulations

REFERENCE:

- G.T. Gully Trap
- D.T. Disconnecter Trap
- C.I.P. Cast Iron Pipe
- S.P.D. Stoneware Pipe Drain
- S.V.P. Soil Vent Pipe
- V.P. Vent Pipe
- E.V. Educt Vent
- I.O. Inspection Opening
- E.J. Expansion Joint
- F.P. Fixed Point
- J.U. Jump Up
- M.H. Man Hole
- O.R.G. Overflow Relief Gully
- F.W. Floor Waste

FIXTURES:

- 1. W. CLOSET (1)
- 2. BATH (1)
- 3. BASIN (1)
- 4. SHOWER (1)
- 5. SINK (1)
- 6. TROUGH (1)
- 7. URINAL (-)
- 8. CLEANER'S SINK (-)
- 9. BIDET (-)

DESIGNED TO N.S.W. CODES OF PRACTICE

NOTES:

1. Drains to be laid shown in BLUE lines.
2. Existing drains shown in GREEN lines.
3. Existing drains X'ed in RED to be abolished to approval.
4. Drains to be supported on or from solid ground.
5. Manholes to be constructed in accordance with N.C.D.C - G.E.E.P. - Hydraulics Plate No. S.01 and shall be fitted with approved cast iron covers.
6. Copper pipes to be in accordance with AS.1432-1973 Table 2 Type B tubes.
7. Cast Iron pipes and fittings to be in accordance with AS.1631-1974.
8. Unplasticised Polyvinyl Chloride Pipe Drains (U.P.V.C.) including STACKS, to be constructed in accordance with AS.2032-1977, and Canberra Codes of Practice
9. Inspection Openings must be provided at the property boundary: on each W.C. or slop-hopper branch; at intervals of not more than 30 metres spaced equidistant where possible; immediately upstream and downstream of all jump-ups.
10. Drains under building must be retested - drains having cement joints must be totally surrounded with cement concrete 150 mm thick.
11. Connection to existing man/manhole to be made by A.C.T.E.W. at Contractor's expense.
12. Sewer branch to be located on site before any work is commenced.
13. This plan to be read in conjunction with approved Architectural Plans and Specifications.
14. Provide and install approved fire stop collars to all U.P.V.C. penetrations of fire rated walls and floors. to Building Sections' Regulations

CANBERRA SEWERAGE AND WATER SUPPLY REGULATIONS
SUB-REGULATION 18 (1)

HOUSE CONNEXION SEWERS APPROVED

[Signature] ENGINEER 9 NOV 1990

Designed by: BIRD MOORE & PARTNERS

Drawn: *[Signature]* 10.90 Ref: A599

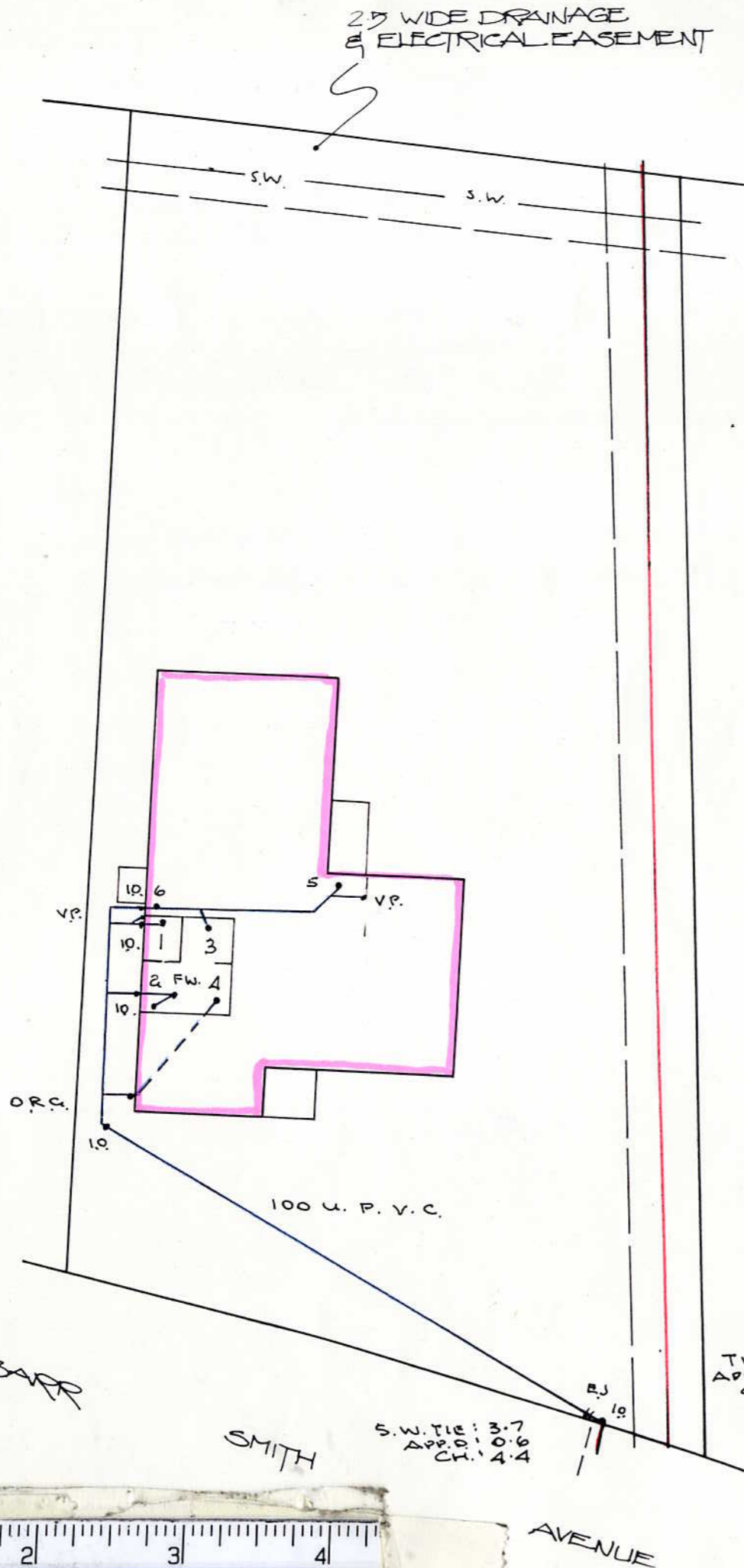

Overflow Relief Gully (O.R.G.):
Top to be minimum 300mm
below lowest fitting with a
further 50mm from top to
paving level or a further
150mm from top to unpaved
ground level. Refer 6.4.5
NSW Code of Practice.



79057
APPROVED
SUBJECT TO APPROVAL OF
BUILDING PLAN

**APPROVAL OF THIS PLAN IS GIVEN SUBJECT TO
THE WORK BEING CARRIED OUT IN ACCORD-
ANCE WITH THE CANBERRA SEWERAGE AND
WATER SUPPLY REGULATIONS**

Energy Efficiency Rating



UNDERSTANDING YOUR ENERGY EFFICIENCY RATING (EER)

An energy efficiency rating (EER) is a rating used to identify the energy efficiency of homes in the ACT.

The Civil Law (Sale of Residential Property) Act 2003 requires all homes being sold in the ACT to carry an energy efficiency rating (EER). This enables owners and buyers to compare a home's passive energy performance characteristics with others for sale in the Territory.

In the ACT, established homes are assessed using 1st generation software, and can achieve **0 to 6 stars** in the rating scheme.

Houses with a higher EER are more cost and energy efficient, use less energy for heating and cooling, generate lower greenhouse gas emissions, and are more comfortable.

What information is taken into account when assessing my homes energy efficiency?

- Layout of the home
- Construction of its roof, walls, windows, and floor
- Wall, floor, and ceiling insulations
- Orientation of windows and shading of the sun's path and local breezes
- Influence of the local climate
- Air leakages

What information is not applicable when assessing my homes energy efficiency?

- Heating and cooling
- Hot water systems
- Lighting systems and appliances
- Solar panels

How can I improve my energy efficiency rating?

Your energy efficiency report will include a list of design options (unless it's already achieved the maximum rating of 6 stars). This will outline the improvements that can be made to gain additional points and increase the overall star rating of your home.

When I built my home, I was provided with a 10-star energy rating. Why has this decreased?

The ACT Government has two software systems in place to generate energy efficiency ratings:

1. Established homes: An on site assessment using 1st generation software. A maximum of 6 stars can be achieved.
2. Brand new homes: A computer based assessment using 2nd generation software. A maximum of 10 stars can be achieved.

If you hold an energy efficiency rating that exceeds 6 stars, it is a 2nd generation EER and would have been provided when your home was brand new.

When assessing a home's energy efficiency for the purpose of sale, property inspection companies are required to use 1st generation software, which will achieve a maximum of 6 stars.

FirstRate Report

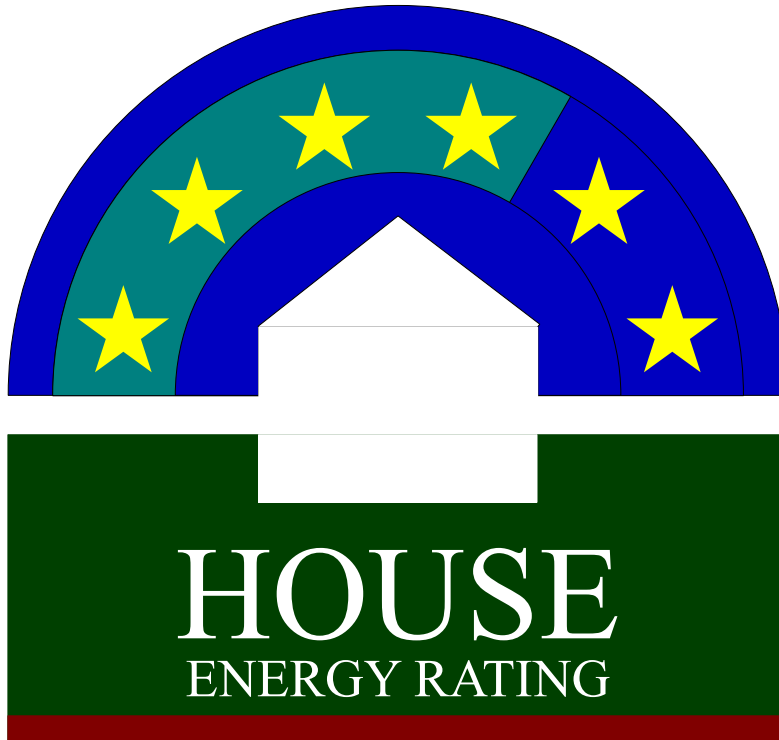

YOUR HOUSE ENERGY RATING IS: ★★☆☆ **4 STARS**
in Climate: 24 **SCORE: -10 POINTS**

Name: Vujik & Vujic

Ref No: 69115

House Title: Block 2 Section 23 BONYTHON

Date: 08-04-2026

Address: 89 Barr Smith Avenue, Bonython ACT 2905

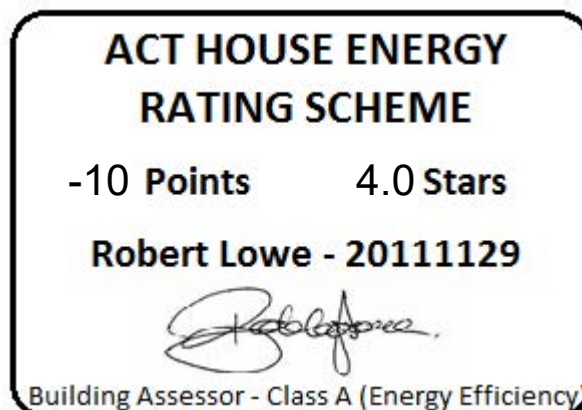

This rating only applies to the floor plan, construction details, orientation and climate as submitted and included in the attached Rating Summary. Changes to any of these could affect the rating.

IMPROVING YOUR RATING

The table below shows the current rating of your house and its potential for improvement.

Star Rating	POOR			AVERAGE				GOOD			V. GOOD	
	0 Star	★	★★	★★★	★★★★	★★★★★	★★★★★★	★★★★★★★	★★★★★★★★	★★★★★★★★★		
Point Score	-71	-70	-46	-45	-26	-25	-11	-10	4	5	16	17

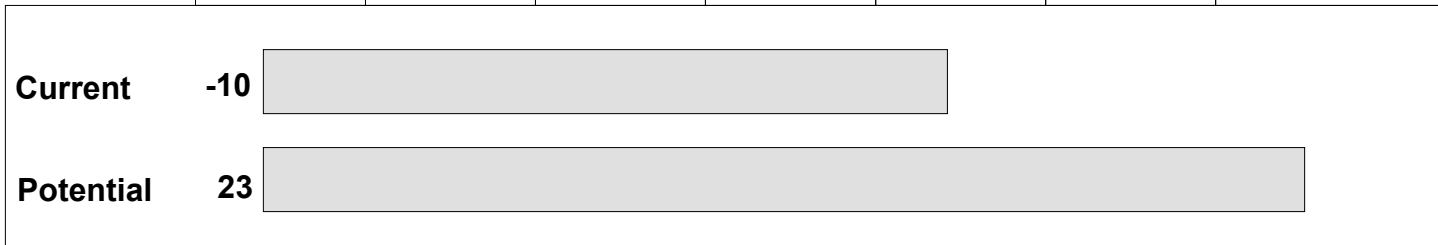

Incorporating these design options will add the additional points required to achieve the potential rating shown in the table. Each point represents about a 1% change in energy efficiency. This list is only a guide to the range of options that could be used.

Design options

Additional points

Change frame to Aluminium-Improved	9
Change curtain to Heavy Drapes & Pelmets	17
Seal Exhaust fans	2
Seal Internal Doors	2
Seal Gaps & Cracks	3

ORIENTATION

Orientation is one of the key factors which influences energy efficiency. This dwelling will achieve different scores and star ratings for different orientations.

Current Rating	-10	★★★★
-----------------------	------------	-------------

Largest windows in the dwelling;

Direction : North East

Area : 10 m²

The table below shows the total score for the dwelling when these windows face the direction indicated.

Note that obstructions overshadowing windows have been removed from all windows in these ratings to allow better comparisons to be made between orientations.

ORIENTATION	POINT SCORE	STAR RATING
1. North East	-10	★★★★
2. East	-14	★★★★☆
3. South East	-17	★★★
4. South	-17	★★★★☆
5. South West	-18	★★★
6. West	-14	★★★★☆
7. North West	-11	★★★★☆
8. North	-7	★★★★

FirstRate Mode
Climate: 24

RATING SUMMARY for: Block 2 Section 23 BONYTHON, 89 Barr Smith Avenue, Bonython ACT 2905,

Assessor's Name:

Net Conditioned Floor Area: 104.5 m²

			Points		
Feature			Winter	Summer	Total
CEILING			2	0	2
Surface Area:	0	Insulation:	2		
WALL			-1	1	-1
Surface Area:	-4	Insulation:	4	Mass:	0
FLOOR			10	0	10
Surface Area:	0	Insulation:	-4	Mass:	14
AIR LEAKAGE (Percentage of score shown for each element)			1	0	1
Fire Place	0 %	Vented Skylights	0 %		
Fixed Vents	0 %	Windows	22 %		
Exhaust Fans	27 %	Doors	20 %		
Down Lights	0 %	Gaps (around frames)	32 %		
DESIGN FEATURES			0	0	0
Cross Ventilation	0				
ROOF GLAZING			0	0	0
Winter Gain	0	Winter Loss	0		

WINDOWS							-29	-8	-37
Window Direction	Area		Point Scores				Total		
	m2	%NCFA	Winter* Loss	Winter Gain	Summer Gain				
NE	10	10%	-23	19	-4	-8			
SE	4	4%	-8	2	-1	-7			
SW	5	5%	-11	1	-1	-10			
NW	6	5%	-14	4	-2	-11			
Total	24	23%	-56	27	-8	-37			

* Air movement over glazing can significantly increase winter heat losses. SEAV recommends heating/cooling duct outlets be positioned to avoid air movement across glass or use deflectors to direct air away from glass.

The contribution of heavyweight materials to the window score is -2 points

			Winter	Summer	Total
RATING	★★★★	SCORE	-17	-6	-10*

* includes 14 points from Area Adjustment

Detailed House Data

House Details

ClientName Vujik & Vujic
HouseTitle Block 2 Section 23 BONYTHON
StreetAddress 89 Barr Smith Avenue, Bonython ACT 2905
FileCreated 08-04-2026
Comments Toliet utility

Climate Details

State
Town Canberra
Postcode 2600
Zone 24

Floor Details

ID	Construction	Sub Floor	Upper	Shared	Foil	Carpet	Ins RValue	Area
1	Concrete Slab on ground	No Subfloor	No	No	No	Carp	R0.0	32.1m ²
2	Concrete Slab on ground	No Subfloor	No	No	No	Float Timb	R0.0	76.5m ²
3	Concrete Slab on ground	No Subfloor	No	No	No	Tiles	R0.0	8.2m ²

Wall Details

ID	Construction	Shared	Ins RValue	Length	Height
1	Brick Veneer	No	R1.5	49.3m	2.4m

Ceiling Details

ID	Construction	Shared	Foil	Ins RValue	Area
1	Attic - Standard	No	No	R3.0	116.8m ²

Window Details

ID	Dir	Height	Width	Utility	Glass	Frame	Curtain	Blind	Fixed & Adj Eave	Fixed Eave	Head to Eave
1	NE	2.0m	1.5m	No	SG	ALSTD	HB	No	0.6m	0.6m	0.1m
2	NE	2.0m	1.5m	No	SG	ALSTD	HB	No	0.6m	0.6m	0.1m
3	NE	2.0m	0.2m	No	SGT	TIMB	NC	No	2.3m	2.3m	0.2m
4	NE	2.0m	1.8m	No	SG	ALSTD	HB	No	0.6m	0.6m	0.1m
5	SE	1.0m	1.2m	No	SGT	ALSTD	HB	No	0.6m	0.6m	0.2m
6	SE	1.0m	0.9m	No	SGT	ALSTD	HB	No	0.6m	0.6m	0.2m
7	SE	0.9m	0.3m	Yes	SG	TIMB	NC	No	0.6m	0.6m	0.2m
8	SE	1.0m	1.5m	No	SG	ALSTD	HB	No	0.6m	0.6m	0.1m
9	SW	1.2m	1.5m	No	SG	ALSTD	HB	No	0.6m	0.6m	0.1m
10	NW	1.2m	1.5m	No	SG	ALSTD	HB	No	2.0m	2.0m	0.1m
11	NW	2.1m	1.8m	No	SG	ALSTD	NC	No	2.0m	2.0m	0.1m
12	SW	1.0m	1.2m	No	SG	ALSTD	HB	No	4.0m	4.0m	0.1m
13	SW	1.2m	1.5m	No	SG	ALSTD	HB	No	4.0m	4.0m	0.1m

Window Shading Details

ID	Dir	Height	Width	Obst Height	Obst Dist	Obst Width	Obst Offset	LShape Left Fin	LShape Left Off	LShape Right Fin	LShape Right Off
1	NE	2.0m	1.5m	0.0m	0.0m	0.0m	0.0m	0.0m	0.0m	1.8m	4.0m
2	NE	2.0m	1.5m	0.0m	0.0m	0.0m	0.0m	0.0m	0.0m	1.8m	1.8m
3	NE	2.0m	0.2m	0.0m	0.0m	0.0m	0.0m	0.0m	0.0m	1.8m	0.9m
10	NW	1.2m	1.5m	0.0m	0.0m	0.0m	0.0m	0.0m	0.0m	4.5m	4.0m
11	NW	2.1m	1.8m	0.0m	0.0m	0.0m	0.0m	0.0m	0.0m	4.5m	0.6m
12	SW	1.0m	1.2m	0.0m	0.0m	0.0m	0.0m	6.6m	0.0m	0.0m	0.0m
13	SW	1.2m	1.5m	0.0m	0.0m	0.0m	0.0m	6.6m	2.3m	0.0m	0.0m

Zoning Details

Is there Cross Flow Ventilation ? Good

Air Leakage Details

Location	Suburban
Is there More than One Storey ?	No
Is the Entry open to the Living Area ?	Yes
Is the Entry Door Weather Stripped ?	Yes
Area of Heavyweight Mass	0m ²
Area of Lightweight Mass	0m ²

	<u>Sealed</u>	<u>UnSealed</u>
Chimneys	0	0
Vents	0	0
Fans	0	1
Downlights	0	0
Skylights	0	0
Utility Doors	0	2
External Doors	0	0

Unflued Gas Heaters	0
Percentage of Windows Sealed	98%
Windows - Average Gap	Small
External Doors - Average Gap	Small
Gaps & Cracks Sealed	No

Insurance Certificates & Tax Invoice



If a home was built before 1990 it may contain dangerous asbestos material

Identify where asbestos materials might be. Five common places are:



- 1.** Exterior
roof sheeting, gutters, downpipes,
ridge capping, eaves, cladding,
electrical switchboards

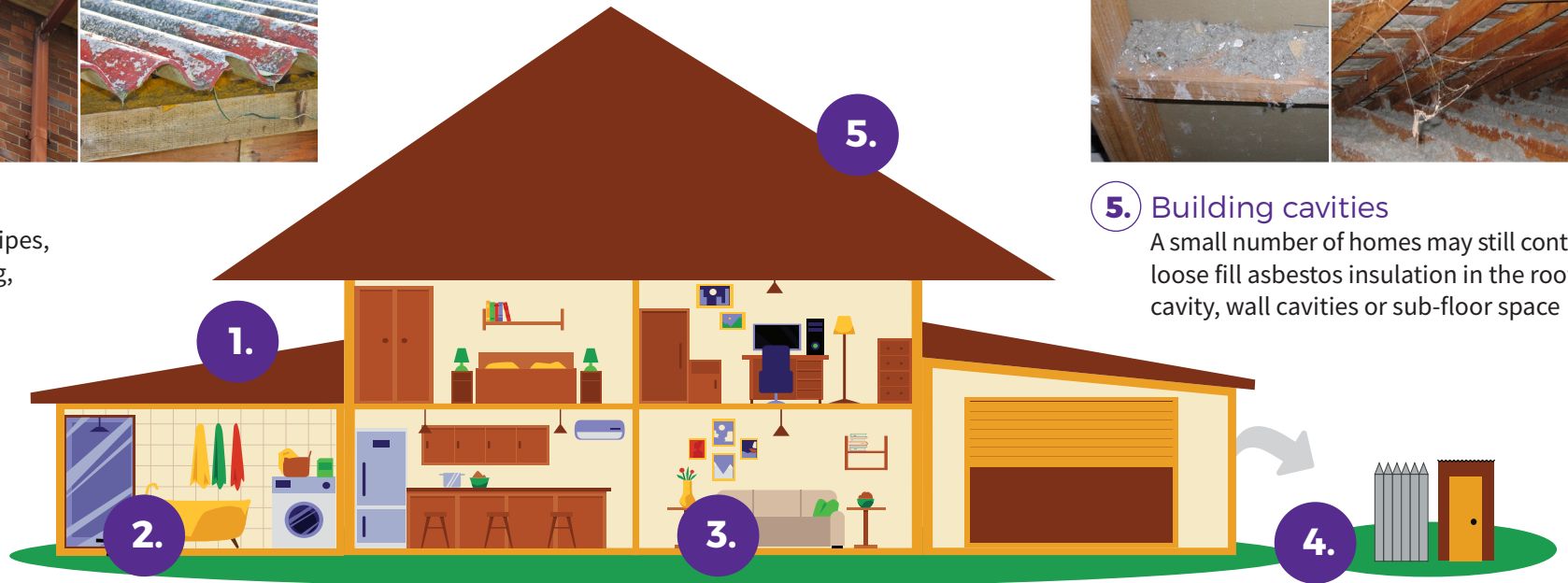

- 5.** Building cavities
A small number of homes may still contain
loose fill asbestos insulation in the roof
cavity, wall cavities or sub-floor space



- 2.** Wet areas - bathroom, laundry and kitchen
wall and ceiling panels, vinyl floor tiles, backing for wall tiles
and splashbacks, hot water pipe insulation



- 3.** Internal areas
wall and ceiling panels, carpet underlay,
textured paint, insulation in domestic
heaters



- 4.** Backyard
fences, sheds, garages, carports, dog kennels, buried or
dumped waste, letterboxes, swimming pools

If a home was built before 1990 it may contain dangerous asbestos material

Assess the risk

A licensed asbestos assessor can help identify asbestos in your home and its condition.

Asbestos materials become dangerous when:



Broken or in poor condition



Damaged accidentally



Disturbed during renovation or repairs



Loose fill asbestos insulation



Manage asbestos safely

- Monitor the condition of asbestos in your home
- Inform tradespeople of locations of asbestos in your home
- Avoid disturbing or damaging asbestos if working on your home
- Engage a licensed asbestos removalist to remove asbestos

If you suspect your home contains loose fill asbestos insulation, contact Access Canberra

For more information, visit www.worksafe.act.gov.au or call Access Canberra contact centre – 13 22 81

58 of 62

If you need interpreting help, telephone the Translating and Interpreting Service on 131 450

Authorised by the ACT Parliamentary Counsel—also accessible at www.legislation.act.gov.au

*Advice based on the Asbestos Safety and Eradication Agency's residential asbestos disclosure research.

Pest Controllers Combined Liability Certificate of Currency

The Policy below is current until 4.00pm on the expiry date shown below

INSURED: ACT Property Inspections Pty Ltd

BUSINESS DESCRIPTION: General Pest & Weed Control
Timber Pest Inspections
Termite Barrier Installations
Pre-Purchase House Pest Inspections
Building Inspections (Non Pest Related)
Energy Efficiency Ratings
Compliance Reports

POLICY REFERENCE: 09A349653PLB

PERIOD OF INSURANCE: From: 4.00pm on 30/03/2025
To: 4.00pm on 30/03/2026

POLICY CLASS: Pest Controllers Combined Liability

SUMS INSURED: **Section 1: General Public & Products Liability**

\$20,000,000 Our maximum liability in respect of any claim or series of claims for Personal Injury, Property Damage or Advertising Liability caused by or arising out of any one occurrence; and

\$20,000,000 Our total aggregate liability during any one period of insurance for all claims arising out of Your Product

Section 2: Professional Indemnity

\$5,000,000 Our maximum liability in respect of any Claim or any series of Claims inclusive of costs and expenses.

\$10,000,000 Our total aggregate liability for all Claims inclusive of costs and expenses.

This Certificate of Currency is subject to the Policy Documentation to be read in conjunction with the Definitions, Conditions and Exclusions in the Pest Controllers Combined Liability Insurance Policy.

Date Issued: 28 March 2025

TO WHOM THIS MAY CONCERN

9th March 2026

Certificate of Currency

Dear Sir or Madam,

We, the undersigned Insurance Brokers acting on behalf of the Insured, hereby certify that the following described insurance is in force at this date.

TYPE OF INSURANCE: Professional Indemnity Insurance

INSURED: ACT Property Inspections Pty Ltd.

ADDRESS OF INSURED: Unit 1/33 Atree Court, Phillip ACT 2606, Australia.

POLICY NUMBER: B0507OE2600060

PERIOD: From: 30th March 2026 to: 30th March 2027
At 4pm Local Standard Time at the Principal Address of the Insured.

LIMIT OF LIABILITY: AUD 5,000,000 in the annual aggregate inclusive of costs and expenses plus one reinstatement.

INSURERS: 100% Lloyd's of London

This letter is provided as a matter of information only and confers no rights on the holder. Our duties in relation to this insurance are to our client and we accept no duty of care or responsibility to you or any other third party and any liability to you or a third party is excluded. This letter does not amend, extend, or alter the coverage afforded by the policy, nor does it purport to set out all of the policy terms, conditions and exclusions. The policy terms, conditions, limits, and exclusions may alter after the date of this document or the insurance may terminate or be cancelled, and the limits shown may be reduced to pay claims. We have no obligation to advise you of any changes which may be made to the policy or to advise you of their cancellation or termination.

Issued on behalf of Price Forbes & Partners



Adam Power
Executive Director

TO WHOM THIS MAY CONCERN

9th March 2026

Certificate of Currency

Dear Sir or Madam,

We, the undersigned Insurance Brokers acting on behalf of the Insured, hereby certify that the following described insurance is in force at this date.

TYPE OF INSURANCE: Professional Indemnity Insurance

INSURED: ACT Property Inspections Pty Ltd.

ADDRESS OF INSURED: Unit 1/33 Atree Court, Phillip ACT 2606, Australia.

POLICY NUMBER: B0507OE2600060

PERIOD: From: 30th March 2026 to: 30th March 2027
At 4pm Local Standard Time at the Principal Address of the Insured.

LIMIT OF LIABILITY: AUD 5,000,000 in the annual aggregate inclusive of costs and expenses plus one reinstatement.

INSURERS: 100% Lloyd's of London

This letter is provided as a matter of information only and confers no rights on the holder. Our duties in relation to this insurance are to our client and we accept no duty of care or responsibility to you or any other third party and any liability to you or a third party is excluded. This letter does not amend, extend, or alter the coverage afforded by the policy, nor does it purport to set out all of the policy terms, conditions and exclusions. The policy terms, conditions, limits, and exclusions may alter after the date of this document or the insurance may terminate or be cancelled, and the limits shown may be reduced to pay claims. We have no obligation to advise you of any changes which may be made to the policy or to advise you of their cancellation or termination.

Issued on behalf of Price Forbes & Partners



Adam Power
Executive Director



**ACT
PROPERTY
INSPECTIONS**

TAX INVOICE

Snezana Vujik & Sam Sinisa Vujic
89 Barr Smith Ave
BONYTHON ACT 2905
AUSTRALIA

Invoice Date
20 Mar 2026

Invoice Number
INV-69115

ACT Property Inspections
(02) 6232 4540
Unit 1, 33 Altree Ct
PHILLIP ACT 2606
ABN: 33 600 397 466

Description	Quantity	Unit Price	GST	Amount AUD
ACTPLA Fees - No GST	1.00	186.70	GST Free	186.70
Property Report	1.00	1,475.73	10%	1,475.73
Energy Efficiency Report (Complimentary)	1.00	0.00		0.00
Deferred Payment (Complimentary)	1.00	0.00		0.00
			Subtotal	1,662.43
			TOTAL GST 10%	147.57
			TOTAL AUD	1,810.00

Due Date: 16 Sep 2026

Payment terms – Deferred payment account. This account should be paid in full within 14 days on the earlier of:

- (a) Settlement of the property
- (b) If the Property has not been listed for sale within 3 months of the Property Inspection Date
- (c) If the property is no longer listed for sale
- (d) 180 days after the Property Inspection Date

Please pay within the payment terms to avoid the Deferred Payment Fee. Note: all bank/legal fees incurred in obtaining payment will be the customer's responsibility

Payment Options

Pexa : please quote the invoice number as the reference

Direct Deposit : BSB: 012084 Account Number: 194679655

Account Name: ACT Property Inspections Pty Ltd

Please reference your name and invoice number

Cheques : please make payable to ACT Property Inspections Pty Ltd

[View and pay online now](#)